

User Manual Easy UPS On-Line Lithium-ion External Battery Pack SRVL48RMBP3U

Important Safety Instructions

SAVE THESE INSTRUCTIONS - This manual contains important instructions that should be followed during installation and maintenance of the battery pack.



Read these instructions carefully and look at the equipment to become familiar with the device before trying to install, operate, service or maintain it. The following special messages may appear throughout this document or on the equipment to warn of potential hazards or to call attention to information that clarifies or simplifies a procedure.



The addition of this symbol either to a “Danger” or “Warning” safety label indicates that an electrical hazard exists which will result in personal injury if the instructions are not followed.



This is the safety alert symbol. It is used to alert you to potential personal injury hazards. Obey all safety messages that follow this symbol to avoid possible injury or death.

DANGER

DANGER indicates a hazardous situation which, if not avoided, **will result in** death or serious injury.

WARNING

WARNING indicates a hazardous situation which, if not avoided, **could result in** death or serious injury.

CAUTION

CAUTION indicates a hazardous situation which, if not avoided, **could result in** minor or moderate injury.

NOTICE

NOTICE is used to address practices not related to physical injury.

Product Handling Guidelines



<18 kg
<40 lb



18-32 kg
40-70 lb



32-55 kg
70-120 lb



>55 kg
>120 lb



Safety and General Information

Inspect the package contents upon receipt. Notify the carrier and dealer if there is any damage. Read Safety Guide supplied with this unit before installing the UPS.

- Adhere to all national and local electrical codes.
- All wiring must be performed by a qualified electrician.
- Changes and modifications to this unit not expressly approved by APC by Schneider Electric could void the warranty.
- This battery pack is intended for indoor use only.
- Do not operate this battery pack in direct sunlight, in contact with fluids, or where there is excessive dust or high humidity.
- Do not operate the battery pack near open windows or doors.
- Be sure the air vents on the battery pack are not blocked. Allow adequate space for proper ventilation.
Note: Allow a minimum of 20 cm clearance on all four sides of the battery pack.
- Additional safety information can be found in the Safety Guide supplied with this unit.

Battery safety

WARNING

RISK OF CHEMICAL HAZARD AND EXCESSIVE HEAT

- Replace the battery pack at least every 10 years or at the end of its service life, whichever is earlier.
- Replace the battery pack immediately when the UPS indicates battery replacement is necessary.
- Replace battery pack with the same part number and type of batteries as originally installed in the equipment.

Failure to follow these instructions can result in death or serious injury.

- Servicing of battery modules should be performed or supervised by personnel knowledgeable about batteries and required precautions. Keep unauthorized personnel away from batteries.
- The battery typically lasts for eight to ten years. Environmental factors impact battery life. Elevated ambient temperatures, frequent discharge due to poor quality power will shorten battery life. Follow the battery manufacturer recommendations.
- For longest battery performance, the ambient temperature should be maintained between 68 and 77 °F (20 and 25 °C).
- APC by Schneider Electric uses Lithium-Ion batteries. Under normal use and handling, there is no contact with the internal components of the battery.
- This equipment contains potentially hazardous voltages. Do not attempt to disassemble the unit. The unit contains no user serviceable parts. Repairs are must performed only by factory trained service personnel.
- Do not drive nails into the battery pack.
- Do not strike the battery pack with a hammer.
- Do not stand on the battery pack.
- Do not short circuit battery pack.
- Do not place or use the battery pack near heat or fire.
- Do not use a dropped, damaged or deformed battery pack.
- Do not use the battery pack to power other equipment.
- Do not attempt to disassemble the unit. The unit does not contain any user serviceable parts. Repairs must performed only by factory trained service personnel.
- CAUTION: Failed batteries can reach temperatures that exceed the burn thresholds for touchable surfaces.
- CAUTION: A battery can present a risk of electrical shock and high short-circuit current. The following precautions should be taken when working on batteries:
 - Disconnect the charging source prior to connecting or disconnecting battery terminals.
 - Do not wear any metal objects including watches and rings.
 - Do not lay tools or metal parts on top of batteries.
 - Use tools with insulated handles.
 - Wear rubber gloves and boots.
 - Determine if battery is either intentionally or inadvertently grounded. Contact with any part of a grounded battery can result in electric shock and burns by high short-circuit current. The risk of such hazards can be reduced if grounds are removed during installation and maintenance by a skilled person.

- Keep cells and batteries clean and dry.
- Turn off battery before connecting or disconnecting to any UPS or charging source.
- In the event of a cell leaking, do not allow the liquid to come in contact with the skin or eyes. If contact has been made, wash the affected area with copious amounts of water and seek medical advice.
- CAUTION: Before installing or replacing the batteries, remove jewelry such as wristwatches and rings. High short circuit current through conductive materials could cause severe burns.
- CAUTION: Do not dispose of batteries in a fire. The batteries may explode.
- CAUTION: Do not open or tamper with the battery enclosure. Doing so will expose the cell terminals which poses an energy hazard.
- CAUTION: Do not open or mutilate batteries. Released material is harmful to the skin and eyes. It may be toxic.
- CAUTION: Failed batteries can reach temperatures that exceed the burn thresholds for touchable surfaces.
- CAUTION: Turn off UPS before replacing battery.

General Information

- Always recycle used batteries.
- Recycle the package materials or save them for reuse.
- Select a location sturdy enough for the combined weight of the unit.
- Operate the UPS within the specified environmental limits.
- Be sure to deliver the used battery to a recycling facility or ship it to Schneider Electric in the replacement battery packing material.
- While disconnecting unit, turn off the battery pack as well.

Product Description

The APC™ by Schneider Electric external battery pack connects to selected APC by Schneider Electric Uninterruptible Power Supply (UPS) models. The UPS and the external battery pack provide extended protection for electronic equipment from utility power blackouts, brownouts, sags, and surges. The external battery pack provides continuous power until utility power returns to specific levels or the batteries are fully discharged. The UPS and the external battery pack are packed separately.





This user manual is available in the package and on the APC by Schneider Electric website, www.apc.com.

Package Contents

Read the Safety Guide before installing the battery pack.

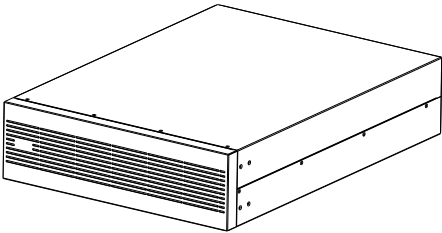
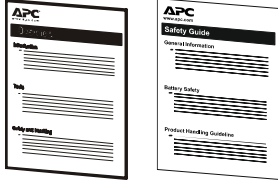
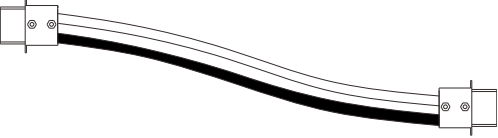
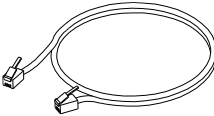
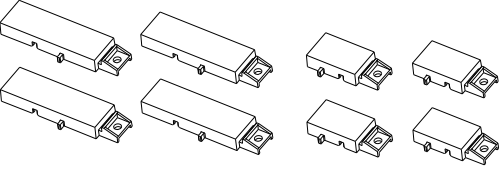
Inspect the package contents upon receipt. Notify the carrier and dealer if there is any damage. The packaging is recyclable; save it for reuse or dispose of it properly.

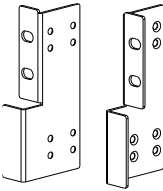
Note: The model and serial numbers are located on a small, rear panel label.

<p>Battery pack</p> 	<p>User manual & Safety guide</p> 	
<p>Battery cable (400mm)</p> 	<p>RJ11 cable</p> 	
<p>Extension kits</p>  <p>Pan head screws x 8</p> 	<p>Rack-mount bracket</p>  <p>Flat head screws x 8</p> 	<p>Grounding cable x 1</p> 

Optional accessories

For optional accessories, refer to the APC by Schneider Electric Website at www.apc.com.

Specifications

Environment specifications

NOTICE

RISK OF EQUIPMENT DAMAGE

- Battery pack must be used indoors only.
- The installation location should be sturdy to withstand the weight of the battery pack.
- Do not operate battery pack where there is excessive dust or where the temperature or humidity are outside specified limits.

Failure to follow these instructions can result in equipment damage.

		SRVL48RMBP3U
Temperature	Discharge	0 to 50 °C
	Recharge	0 to 50 °C
	Storage	-20 to 60 °C During storage, charge the battery every 6 months.
Elevation	Operating	0 - 3,000 m
	Storage	0 - 15,000 m
Humidity	0 to 95% relative humidity, non-condensing	
International Protection Code	IP20	

Physical Specifications

Model	SRVL48RMBP3U
Dimensions with individual pallet Height x Width x Depth	412 x 600 x 800 mm (16.22 x 23.62x 31.50 in)
Dimensions without package Height x Width x Depth	131 x 438 x 616 mm (5.16 x 17.24 x 24.25 in) *D1=573 mm, D2=680 mm
Weight with individual pallet	64.3 kgs (141.8 lbs)
Weight without package	49.5 kgs (109.1 lbs)

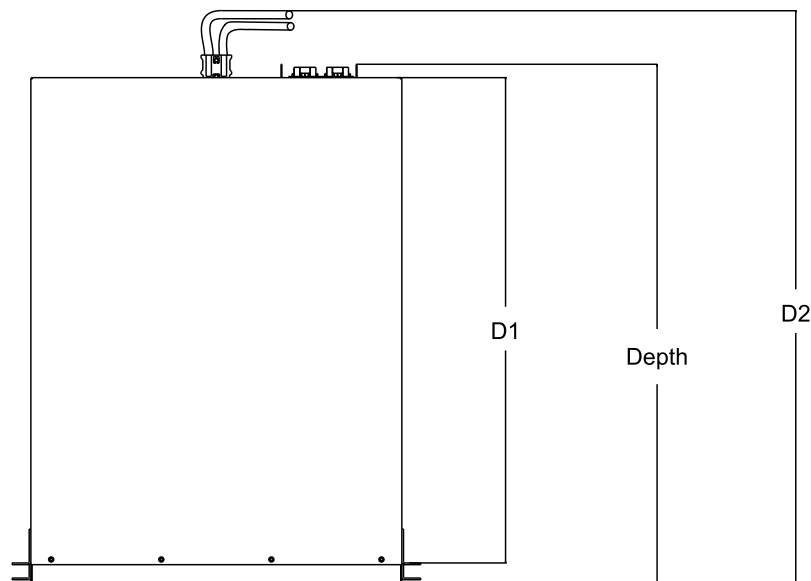

Battery Specifications

Model	SRVL48RMBP3U
Typical Capacity	4800 Wh
Cell Positive electrode	Lithium Ion
Nominal Voltage	48 V
Recommend Charge Voltage	52.5 V±0.5%
Fully Discharge Voltage	37.5 V
Recommend Charge Current	20 A (0 ~ 5 °C) 30 A (5 ~ 45 °C) 20 A (45 °C ~ 50 °C)
Maximum Continuous Discharge Current	150 A
Over Current Protection	Circuit Breaker
Communication Port	RS485 (RJ45)
Communication for battery pack connected in parallel	CAN (RJ11)

* Turn off UPS before replacing battery.

Rear Panel Features

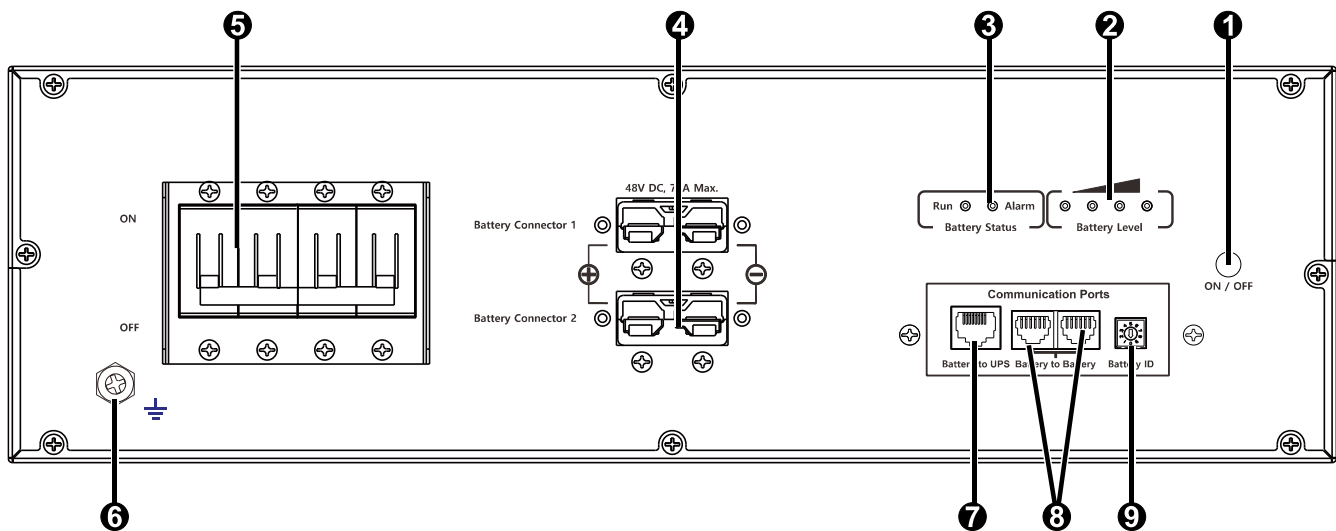

1	MANUAL ON/OFF button	6	Ground screw
2	Battery level LED	7	Battery Management System (BMS) COM port (RJ45)
3	Status LED	8	Extension port (RJ11)
4	Battery connector	9	ID switch
5	Circuit breaker		

Actual XBP may differ in appearance from illustration.

LED Indicators

LED Definitions

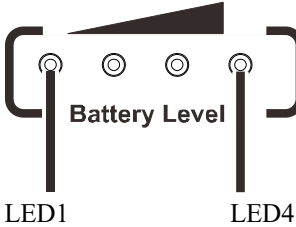
Status	Definition
	Battery Status: Two indicators to display battery status.
	Run Illuminates Green to indicate that the UPS is on battery mode.
	Alarm Illuminates Red Flashing: Alert and indicate that event has been detected. Illuminates Red ON: Battery pack internal error detected.
	Battery Level: The battery level is indicated by the number of illuminated LEDs. When all four LED are illuminated, the battery is fully charged. Each LED represents approximately 25% of the battery status of charge.

LED Behaving

Battery Status		Status LEDs		Battery Level LEDs							
Status	SOC	Run	Alarm	LED1	LED2	LED3	LED4				
Normal Mode	Charging	0%~25%	ON	OFF	Flashing	OFF	OFF	OFF			
		26%~50%	ON	OFF	ON	Flashing	OFF	OFF			
		51%~75%	ON	OFF	ON	ON	Flashing	OFF			
		76%~100%	ON	OFF	ON	ON	ON	Flashing			
	Discharging	0%~25%	ON	OFF	ON	OFF	OFF	OFF			
		26%~50%	ON	OFF	ON	ON	OFF	OFF			
		51%~75%	ON	OFF	ON	ON	ON	OFF			
		76%~100%	ON	OFF	ON	ON	ON	ON			
Alarm Mode	Alert	OFF	Flashing	Status of Battery Level LEDs can be any of the above.							
	Internal error detected	OFF	ON								
COM cable not connected		OFF	Flashing								
Power Off		OFF	OFF					OFF	OFF	OFF	OFF

Note: The Battery Status LEDs and Battery Level LEDs will be on for 0.75 seconds and off for 0.75 seconds while flashing.

Tower Installation

⚠ CAUTION

RISK OF FALLING EQUIPMENT

- The battery pack is heavy. Always practice safe lifting techniques adequate for the weight of the equipment.
- Be sure that the stabilizer brackets are installed along with the battery pack in tower orientation.

Failure to follow these instructions could result in equipment damage and minor or moderate injury.

Installing stabilizer brackets

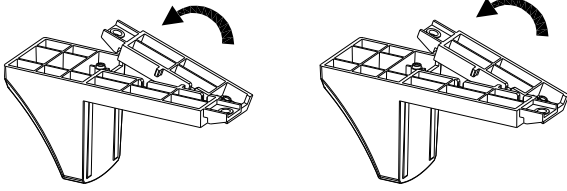
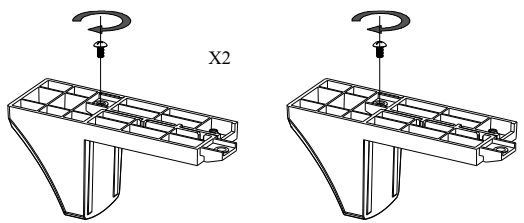
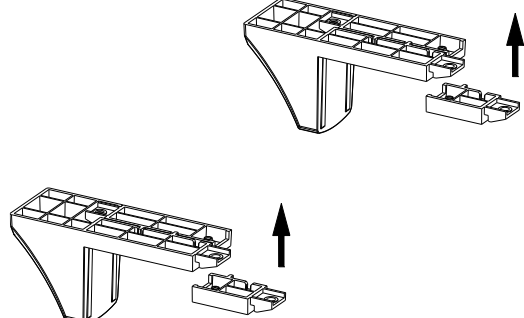
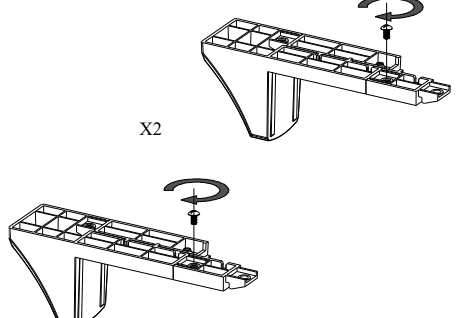
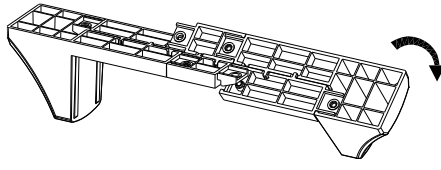
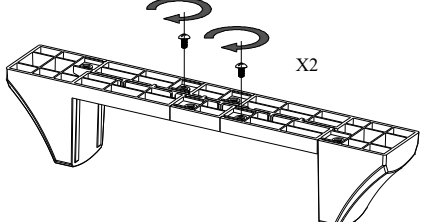
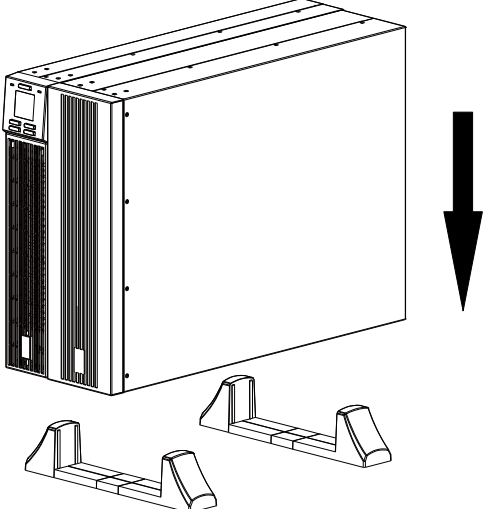
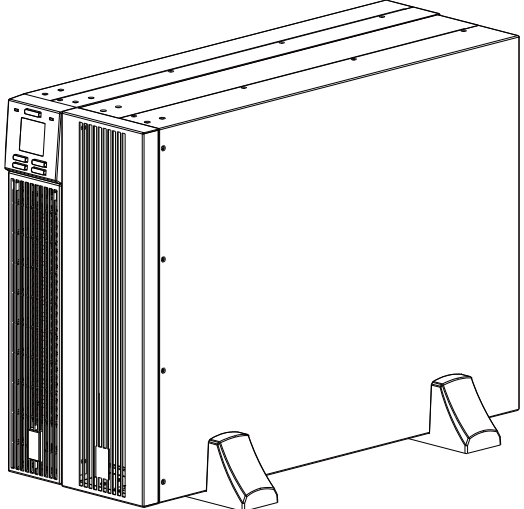
<p>1 Note: The Stabilizer Bracket of the schematic is from 2U UPS accessories.</p> 	<p>2 Note: Use Pan head screws for assembling Stabilizer brackets and Extension pieces.</p> 
<p>3</p> 	<p>4</p> 
<p>5</p> 	<p>6</p> 
<p>7</p> 	<p>8</p> 

NOTE: Maintain approximately 70 mm distance from the edge of the unit, when installing the stabilizer brackets to the Easy UPS.

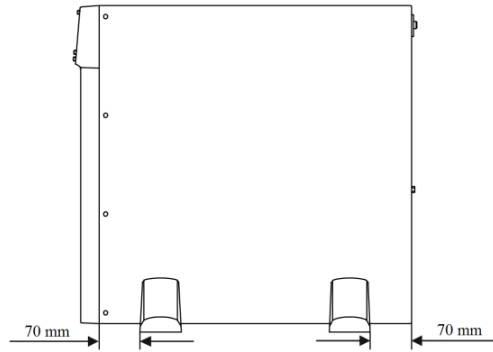

Rack-Mount Installation

CAUTION

RISK OF FALLING EQUIPMENT

- Practice correct lifting techniques adequate for the weight of the equipment.
- Install battery pack at the bottom of the rack.
- Install the UPS above the battery pack.
- Secure the rack-mount brackets to the unit using all of the screws supplied for this purpose.
- Secure the unit in the rack using all of the screws supplied for this purpose.

Failure to follow these instructions could result in equipment damage and minor or moderate injury.

- Before installing the battery pack into the 19 inch rack enclosure, be sure that the rack is already equipped with a shelf.
- Be sure that the installed shelf can withstand the weight of the UPS and/or battery pack. Otherwise, install an optional rail kit accessory (SRVRK2) which can be purchased separately.

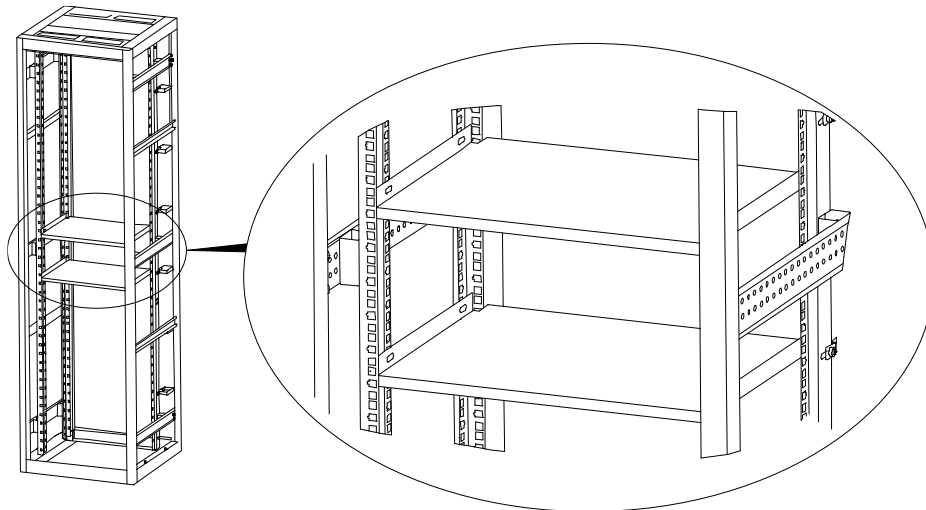

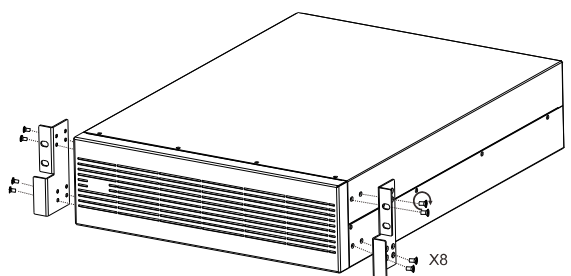
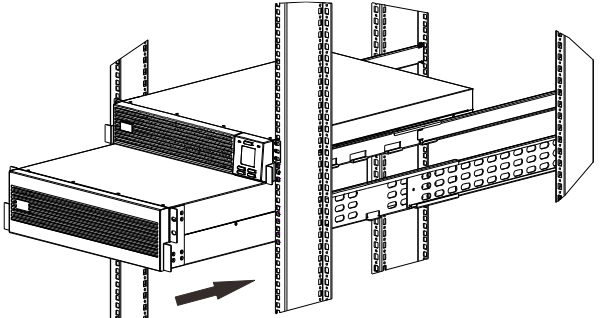
<p>1 Install the rack-mount brackets using the Flat head screws.</p> 	<p>2 Lift the battery pack and slide it into rack enclosure.</p> 
---	--

3 Secure the battery pack to the rack with screws, nuts and washers (not supplied in the package).

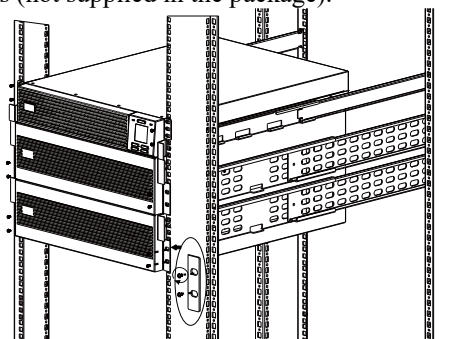

Operation

The battery pack can either be turned ON manually or automatically through the UPS.

Turn ON the battery pack manually

1. Switch ON the circuit breaker on the battery pack.
2. Press and hold the MANUAL ON/OFF switch for 5 seconds to turn ON the battery pack.

Turn ON the battery pack automatically

1. Connect the input utility power to the UPS.
2. Switch ON the circuit breaker on the battery pack. The UPS will start up and the battery pack also gets turned ON automatically.

Turning OFF the battery pack

The battery pack should be turned OFF manually.

1. Press and hold the MANUAL ON/OFF switch for 5 seconds to turn OFF the battery pack.
2. Turn OFF the circuit breaker.

NOTE: Shut down the UPS and turn OFF the battery pack circuit breaker if the UPS will not be used for a long period.

NOTE: Charge the battery modules every six months when not in use.

Troubleshooting

Use the table below to solve minor installation and operation problems. Refer to the APC by Schneider Electric website, www.apc.com for assistance with complex problems.

Problem and/or Possible Cause	Solution
UPS is not supplying power to the connected equipment while operating on Battery mode.	
The battery is not connected.	<ol style="list-style-type: none"> 1. Be sure that battery cable is properly secured at both the UPS and the battery pack. 2. Be sure that the first battery pack (master battery pack) ID switch is set to 0 and all IDs should be set differently.
Low battery cut off.	<p>UPS may have discharged the battery due to utility power outage and turned the output off due to low battery condition.</p> <p>Wait for the utility power to be restored and charge the battery.</p>
Battery temperature is not within specifications (cell temperature lesser than -20 °C or greater than 80 °C).	Be sure the air vents on the battery pack are not blocked and adequate space for proper ventilation is available.
The battery pack is experiencing an overload condition.	Disconnect nonessential equipment from the UPS to correct the overload condition.
Battery output terminals are short circuited.	Remove the short circuit at the output terminals of the battery and charge the battery.
Battery is not getting charged when UPS is working Online mode.	
Battery temperature is not within specifications (cell temperature lesser than -20 °C or greater than 80 °C).	Be sure the air vents on the battery pack are not blocked and adequate space for proper ventilation is available.
Communication failure is detected.	
Communication lost between the battery pack and UPS, or between battery packs. Or the ID setting of each parallel battery pack is duplicated in the parallel battery mode.	<ol style="list-style-type: none"> 1. Be sure that the communication wire (RJ45) between the UPS and the master battery pack is properly secured. 2. Be sure that the communication wires (RJ11) between the battery packs are properly secured. 3. Be sure that the ID setting of master battery pack is “0” and each parallel battery pack is unique.
Alarm LED keep ON and can not be disabled.	
An internal error detected.	<ol style="list-style-type: none"> 1. Make sure all battery cables are firmly connected, RJ11 and RJ45 cables are correctly connected, and IDs in each battery pack is set differently. 2. Make sure battery pack is not in deep discharging status. Charging battery can solve this problem. Suggest to charge battery packs at least 24 hours. 3. Make sure battery pack is not in over charging status. Discharging battery can solve this problem. Suggest to connect 50% load to discharge battery pack until 50% SOC. 4. Make sure battery pack is not in over-temperature status. Ensure the working environment is lower than 50°C. <p>If the problem still remains, disconnect the UPS from the AC Mains and contact APC by Schneider Electric Customer Support.</p>

Transport

1. Shut down and disconnect all connected equipment.
2. Disconnect the unit from mains power.
3. Disconnect all internal and external batteries (if applicable).
4. Follow the shipping instructions outlined in the *Service* section of this manual.

Service

If the unit requires service, do not return it to the dealer. Follow these steps:

1. Review the *Troubleshooting* section of the manual to eliminate common problems.
2. If the problem persists, contact APC by Schneider Electric Customer Support through the APC by Schneider Electric website, **www.apc.com**.
 - a. Note the model number and serial number and the date of purchase. The model and serial numbers are located on the rear panel of the unit.
 - b. Call Customer Support. A technician will attempt to solve the problem over the phone. If this is not possible, the technician will issue a Returned Material Authorization Number (RMA#).
 - c. If the unit is under warranty, the repairs are free.
 - d. Service procedures and returns may vary internationally. For country specific instructions refer to the APC by Schneider Electric website, **www.apc.com**.
3. Pack the unit properly to avoid damage in transit. Never use foam beads for packaging. Damage sustained in transit is not covered under warranty.
4. Write the RMA# provided by Customer Support on the outside of the package.
5. Return the unit by insured, prepaid carrier to the address provided by Customer Support.
6. Shipment of Lithium Ion Battery is highly regulated and the regulation is evolving. Pack the battery and UPS separately. Always contact Customer Support to get the latest guidance on shipment of Lithium ion battery and UPS.

Limited Factory Warranty

Schneider Electric IT Corporation (SEIT), warrants its products to be free from defects in materials and workmanship for a period of five (5) years from the date of purchase. The SEIT obligation under this warranty is limited to repairing or replacing, at its own sole option, any such defective products. Repair or replacement of a defective product or part thereof does not extend the original warranty period.

This warranty applies only to the original purchaser who must have properly registered the product within 10 days of purchase. Products may be registered online at warranty.apc.com.

SEIT shall not be liable under the warranty if its testing and examination disclose that the alleged defect in the product does not exist or was caused by end user or any third person misuse, negligence, improper installation, testing, operation or use of the product contrary to SEIT recommendations of specifications. Further, SEIT shall not be liable for defects resulting from: 1) unauthorized attempts to repair or modify the product, 2) incorrect or inadequate electrical voltage or connection, 3) inappropriate on site operation conditions, 4) Acts of God, 5) exposure to the elements, or 6) theft. In no event shall SEIT have any liability under this warranty for any product where the serial number has been altered, defaced, or removed.

EXCEPT AS SET FORTH ABOVE, THERE ARE NO WARRANTIES, EXPRESS OR IMPLIED, BY OPERATION OF LAW OR OTHERWISE, APPLICABLE TO PRODUCTS SOLD, SERVICED OR FURNISHED UNDER THIS AGREEMENT OR IN CONNECTION HEREWITH.

SEIT DISCLAIMS ALL IMPLIED WARRANTIES OF MERCHANTABILITY, SATISFACTION AND FITNESS FOR A PARTICULAR PURPOSE.

SEIT EXPRESS WARRANTIES WILL NOT BE ENLARGED, DIMINISHED, OR AFFECTED BY AND NO OBLIGATION OR LIABILITY WILL ARISE OUT OF, SEIT RENDERING OF TECHNICAL OR OTHER ADVICE OR SERVICE IN CONNECTION WITH THE PRODUCTS.

THE FOREGOING WARRANTIES AND REMEDIES ARE EXCLUSIVE AND IN LIEU OF ALL OTHER WARRANTIES AND REMEDIES. THE WARRANTIES SET FORTH ABOVE CONSTITUTE SEIT'S SOLE LIABILITY AND PURCHASER EXCLUSIVE REMEDY FOR ANY BREACH OF SUCH WARRANTIES. SEIT WARRANTIES EXTEND ONLY TO ORIGINAL PURCHASER AND ARE NOT EXTENDED TO ANY THIRD PARTIES.

IN NO EVENT SHALL SEIT, ITS OFFICERS, DIRECTORS, AFFILIATES OR EMPLOYEES BE LIABLE FOR ANY FORM OF INDIRECT, SPECIAL, CONSEQUENTIAL OR PUNITIVE DAMAGES, ARISING OUT OF THE USE, SERVICE OR INSTALLATION OF THE PRODUCTS, WHETHER SUCH DAMAGES ARISE IN CONTRACT OR TORT, IRRESPECTIVE OF FAULT, NEGLIGENCE OR STRICT LIABILITY OR WHETHER SEIT HAS BEEN ADVISED IN ADVANCE OF THE POSSIBILITY OF SUCH DAMAGES. SPECIFICALLY, SEIT IS NOT LIABLE FOR ANY COSTS, SUCH AS LOST PROFITS OR REVENUE, WHETHER DIRECT OR INDIRECT, LOSS OF EQUIPMENT, LOSS OF USE OF EQUIPMENT, LOSS OF SOFTWARE, LOSS OF DATA, COSTS OF SUBSTITUANTS, CLAIMS BY THIRD PARTIES, OR OTHERWISE.

NOTHING IN THIS LIMITED WARRANTY SHALL SEEK TO EXCLUDE OR LIMIT SEIT LIABILITY FOR DEATH OR PERSONAL INJURY RESULTING FROM ITS NEGLIGENCE OR ITS FRAUDULENT MISREPRESENTATION OF TO THE EXTENT THAT IT CANNOT BE EXCLUDED OR LIMITED BY APPLICABLE LAW.

To obtain service under warranty you must obtain a Returned Material Authorization (RMA) number from customer support. Customers with warranty claims issues may access the SEIT worldwide customer support network through the APC by Schneider Electric website: www.apc.com. Select your country from the country selection drop down menu. Open the Support tab at the top of the web page to obtain information for customer support in your region. Products must be returned with transportation charges prepaid and must be accompanied by a brief description of the problem encountered and proof of date and place of purchase.

APC by Schneider Electric Worldwide Customer Support

Customer support for this or any other APC by Schneider Electric product is available at no charge in any of the following ways:

- Visit the APC by Schneider Electric website to access documents in the APC by Schneider Electric Knowledge Base and to submit customer support requests.
 - **www.apc.com** (Corporate Headquarters)
Connect to localized APC by Schneider Electric websites for specific countries, each of which provides customer support information.
 - **www.apc.com/support/**
Global support searching APC by Schneider Electric Knowledge Base and using e-support.
- Contact the APC by Schneider Electric Customer Support Center by telephone or e-mail.
 - Local, country specific centers: go to **www.apc.com/support/contact** for contact information.

For information on how to obtain local customer support, contact the APC by Schneider Electric representative or other distributor from whom you purchased your APC by Schneider Electric product.