



## **Cisco IP Phone 8800 Series User Guide**

**First Published:** 2015-11-25

**Last Modified:** 2023-06-16

### **Americas Headquarters**

Cisco Systems, Inc.  
170 West Tasman Drive  
San Jose, CA 95134-1706  
USA  
<http://www.cisco.com>  
Tel: 408 526-4000  
800 553-NETS (6387)  
Fax: 408 527-0883

THE SPECIFICATIONS AND INFORMATION REGARDING THE PRODUCTS IN THIS MANUAL ARE SUBJECT TO CHANGE WITHOUT NOTICE. ALL STATEMENTS, INFORMATION, AND RECOMMENDATIONS IN THIS MANUAL ARE BELIEVED TO BE ACCURATE BUT ARE PRESENTED WITHOUT WARRANTY OF ANY KIND, EXPRESS OR IMPLIED. USERS MUST TAKE FULL RESPONSIBILITY FOR THEIR APPLICATION OF ANY PRODUCTS.

THE SOFTWARE LICENSE AND LIMITED WARRANTY FOR THE ACCOMPANYING PRODUCT ARE SET FORTH IN THE INFORMATION PACKET THAT SHIPPED WITH THE PRODUCT AND ARE INCORPORATED HEREIN BY THIS REFERENCE. IF YOU ARE UNABLE TO LOCATE THE SOFTWARE LICENSE OR LIMITED WARRANTY, CONTACT YOUR CISCO REPRESENTATIVE FOR A COPY.

The following information is for FCC compliance of Class A devices: This equipment has been tested and found to comply with the limits for a Class A digital device, pursuant to part 15 of the FCC rules. These limits are designed to provide reasonable protection against harmful interference when the equipment is operated in a commercial environment. This equipment generates, uses, and can radiate radio-frequency energy and, if not installed and used in accordance with the instruction manual, may cause harmful interference to radio communications. Operation of this equipment in a residential area is likely to cause harmful interference, in which case users will be required to correct the interference at their own expense.

The following information is for FCC compliance of Class B devices: This equipment has been tested and found to comply with the limits for a Class B digital device, pursuant to part 15 of the FCC rules. These limits are designed to provide reasonable protection against harmful interference in a residential installation. This equipment generates, uses and can radiate radio frequency energy and, if not installed and used in accordance with the instructions, may cause harmful interference to radio communications. However, there is no guarantee that interference will not occur in a particular installation. If the equipment causes interference to radio or television reception, which can be determined by turning the equipment off and on, users are encouraged to try to correct the interference by using one or more of the following measures:

- Reorient or relocate the receiving antenna.
- Increase the separation between the equipment and receiver.
- Connect the equipment into an outlet on a circuit different from that to which the receiver is connected.
- Consult the dealer or an experienced radio/TV technician for help.

Modifications to this product not authorized by Cisco could void the FCC approval and negate your authority to operate the product.

The Cisco implementation of TCP header compression is an adaptation of a program developed by the University of California, Berkeley (UCB) as part of UCB's public domain version of the UNIX operating system. All rights reserved. Copyright © 1981, Regents of the University of California.

NOTWITHSTANDING ANY OTHER WARRANTY HEREIN, ALL DOCUMENT FILES AND SOFTWARE OF THESE SUPPLIERS ARE PROVIDED "AS IS" WITH ALL FAULTS. CISCO AND THE ABOVE-NAMED SUPPLIERS DISCLAIM ALL WARRANTIES, EXPRESSED OR IMPLIED, INCLUDING, WITHOUT LIMITATION, THOSE OF MERCHANTABILITY, FITNESS FOR A PARTICULAR PURPOSE AND NONINFRINGEMENT OR ARISING FROM A COURSE OF DEALING, USAGE, OR TRADE PRACTICE.

IN NO EVENT SHALL CISCO OR ITS SUPPLIERS BE LIABLE FOR ANY INDIRECT, SPECIAL, CONSEQUENTIAL, OR INCIDENTAL DAMAGES, INCLUDING, WITHOUT LIMITATION, LOST PROFITS OR LOSS OR DAMAGE TO DATA ARISING OUT OF THE USE OR INABILITY TO USE THIS MANUAL, EVEN IF CISCO OR ITS SUPPLIERS HAVE BEEN ADVISED OF THE POSSIBILITY OF SUCH DAMAGES.

Any Internet Protocol (IP) addresses and phone numbers used in this document are not intended to be actual addresses and phone numbers. Any examples, command display output, network topology diagrams, and other figures included in the document are shown for illustrative purposes only. Any use of actual IP addresses or phone numbers in illustrative content is unintentional and coincidental.

All printed copies and duplicate soft copies of this document are considered uncontrolled. See the current online version for the latest version.

Cisco has more than 200 offices worldwide. Addresses and phone numbers are listed on the Cisco website at [www.cisco.com/go/offices](http://www.cisco.com/go/offices).

The documentation set for this product strives to use bias-free language. For purposes of this documentation set, bias-free is defined as language that does not imply discrimination based on age, disability, gender, racial identity, ethnic identity, sexual orientation, socioeconomic status, and intersectionality. Exceptions may be present in the documentation due to language that is hardcoded in the user interfaces of the product software, language used based on standards documentation, or language that is used by a referenced third-party product.

Cisco and the Cisco logo are trademarks or registered trademarks of Cisco and/or its affiliates in the U.S. and other countries. To view a list of Cisco trademarks, go to this URL: <https://www.cisco.com/c/en/us/about/legal/trademarks.html>. Third-party trademarks mentioned are the property of their respective owners. The use of the word partner does not imply a partnership relationship between Cisco and any other company. (1721R)

© 2015–2023 Cisco Systems, Inc. All rights reserved.



# CONTENTS

---

## CHAPTER 1

### Your Phone 1

The Cisco IP Phone 8800 Series	1
Feature Support	2
New and Changed Information	2
New and Changed Information for Firmware Release 14.2(1)	3
New and Changed Information for Firmware Release 14.1(1)SR2	3
New and Changed Information for Firmware Release 14.1(1)	3
New and Changed Information for Firmware Release 14.0(1)	4
New and Changed Information for Firmware Release 12.8(1)	4
New and Changed Information for Firmware Release 12.7(1)	5
New and Changed Information for Firmware Release 12.6(1)	6
New and Changed Information for Firmware Release 12.5(1)SR3	6
New and Changed Information for Firmware Release 12.5(1)SR2	6
New and Changed Information for Firmware Release 12.5(1)SR1	6
New and Changed Information for Firmware Release 12.1(1)SR1	7
New and Changed Information for Firmware Release 12.1(1)	7
New and Changed Information for Firmware Release 12.0(1)	8
New and Changed Information for Firmware Release 11.7(1)	8
New and Changed Information for Firmware Release 11.5(1)SR1	9
New and Changed Information for Firmware Release 11.5(1)	9
New and Changed Information for Firmware Release 11.0	10
Phone Setup	10
Adjust the Handset Rest	10
Change the Viewing Angle of Your Phone	11
Connect to the Network	12
Share a Network Connection with Your Phone and Computer	12

- Set Up Wi-Fi Client 12
- Connect to a Preconfigured Wi-Fi Network 13
- Connect to a VPN 13
- Set up a Phone for Use with VPN 14
- Connect with Activation Code Onboarding 14
- Connect to Expressway 15
- Change the Service Mode 16
- Secure the Phone with a Cable Lock 16
- Replace Your Existing Phone with a New Phone 17
- Protect Your Video Phone Camera 18
- Activate and Sign In to Your Phone 18
  - Sign In to Your Phone 18
  - Sign In to Your Extension from Another Phone 18
  - Sign Out of Your Extension from Another Phone 19
  - Sign into Extension Mobility with Your Cisco Headset 19
- Self Care Portal 20
  - Speed-Dial Numbers 21
- Buttons and Hardware 22
  - Phone Keypad Characters 24
  - Navigation 24
  - Softkey, Line, and Feature Buttons 25
  - Phone Screen Features 26
    - Phone Icons 26
    - Clean the Phone Screen 28
  - Badged Icons 28
  - Differences Between Phone Calls and Lines 28
  - USB Ports 29
    - Mobile Device Charging 29
  - Chinese Language Support 29
    - Search Call History 30
    - Add a Speed Dial Button from Your Phone 30
    - Add a New Contact to Your Corporate or Personal Directory 30
  - Bluetooth and Your Phone 31
- Accessibility Features for the Cisco IP Phone 8800 Series 31



Hearing-Impaired Accessibility Features	32
Vision-Impaired and Blind Accessibility Features	33
Voice Feedback	37
Mobility-Impaired Accessibility Features	38
Cisco IP Phone 8800 Series Wall Mount Kit Accessibility	39
Phone Firmware and Upgrades	40
Postpone a Phone Upgrade	40
View the Progress of a Phone Firmware Upgrade	41
Energy Savings	41
Turn On Your Phone	41
Phone Line Modes	42
Normal Line Mode	42
Enhanced Line Mode	42
Additional Help and Information	43
Accessibility Features	43
Troubleshooting	43
Find Information About Your Phone	44
Report Call Quality Issues	44
Report All Phone Issues	44
Lost Phone Connectivity	45
Cisco One-Year Limited Hardware Warranty Terms	45

---

**CHAPTER 2**
**Calls 47**

Audio Path Selection	47
Make Calls	48
Make a Call	48
Make a Call with the Speakerphone	48
Make a Call with a Standard Headset	48
Make a Call with a Phone or Video Address	49
Redial a Number	49
Speed Dial	49
Make a Call with a Speed-Dial Button	50
Make a Call With a Speed-Dial Code	50
Make a Call With a Fast-Dial Button	50

Add a Speed Dial Button from Your Phone	51
Modify a Speed Dial Button from Your Phone	51
Delete a Speed Dial Button from Your Phone	52
Dial an International Number	52
Get Notified When a Contact is Available	52
Calls That Require a Billing Code or Authorization Code	53
Secure Calls	53
Make a Call With A Hotline Phone	53
Answer Calls	53
Answer a Call	54
Answer Call Waiting	54
Decline a Call	54
Ignore a Call	54
Turn On Do Not Disturb	55
Answer a Coworker's Phone (Call Pickup)	55
Answer a Call Within Your Group (Pickup)	55
Answer a Call from Another Group (Group Pickup)	56
Answer a Call From an Associated Group (Other Pickup)	56
Answer a Call Within Your Hunt Group	56
Sign In and Out of a Hunt Group	57
View the Call Queue in a Hunt Group	57
Answer Calls Automatically	57
Trace a Suspicious Call	58
Mark Your Calls as Spam	58
Mark an Unwanted Active Call	58
Mark an Unwanted Video Call	59
Mark an Unwanted Recent Call	59
Remove or Edit a Marked Call	60
Video Calls	60
Make a Video Call	60
Stop Your Video	61
Toggle Between Phone and Video Display	61
Adjust the Picture-In-Picture Position	61
Video Calls and Security	62

Mute your call	62
Hold Calls	62
Put a Call on Hold	62
Answer a Call Left on Hold for Too Long	63
Swap Between Active and Held Calls	63
Call Park	63
Place a Call on Hold with Call Park	64
Retrieve a Call on Hold with Call Park	64
Place a Call on Hold with Assisted Directed Call Park	65
Retrieve a Call on Hold with Assisted Directed Call Park	65
Place a Call on Hold with Manual Directed Call Park	65
Retrieve a Call on Hold with Manual Directed Call Park	65
Forward Calls	66
Transfer a Call to Another Person	66
Conference Calls and Meetings	67
Add Another Person to a Call	67
Swap Between Calls Before You Complete a Conference	67
View and Remove Conference Participants	68
Scheduled Conference Calls (Meet Me)	68
Host a Meet-Me Conference	68
Join a Meet-Me Conference	69
Intercom Calls	69
Make an Intercom Call	69
Answer an Intercom Call	69
Supervise and Record Calls	70
Set Up a Supervised Call	70
Record a Call	71
Prioritized Calls	71
Make a Priority Call	72
Answer a Priority Call	72
Answer a Priority Call While on Another Call	72
Multiple Lines	73
Answer the Oldest Call First	73
View All Calls on Your Phone	73

- View Important Calls 73
- Display Call Notifications on Select Lines with Line Filters 74
  - Create a Line Filter 74
  - Use a Line Filter 74
  - Change a Line Filter 74
- Shared Lines 75
  - Add Yourself to a Call on a Shared Line 75
  - Get Notified Before You Join a Call on a Shared Line 75
  - Enable Privacy on a Shared Line 76
- Mobile Devices and Your Desk Phone 76
  - Phone Calls with Intelligent Proximity 76
    - Pair a Mobile Device with Your Desk Phone 77
    - Switch Connected Mobile Devices 77
    - Delete a Mobile Device 77
    - View Your Paired Bluetooth Devices 78
    - Intelligent Proximity for Mobile Phones 78
    - Intelligent Proximity for Tablets 81
  - Phone Calls with Mobile Connect 81
    - Enable Mobile Connect 82
    - Move a Call from Your Desk Phone to Your Mobile Phone 82
    - Move a Call from Your Mobile Phone to Your Desk Phone 82
    - Transfer a Call from Your Mobile Phone to Your Desk Phone 83
- Voicemail 83
  - Voicemail Message Indication 84
  - Access Your Voicemail Messages 84
  - Visual Voicemail 84
    - Access Audio Voicemail 85
  - Transfer a Call to Voicemail 85

---

CHAPTER 3

**Contacts 87**

- Corporate Directory 87
  - Dial a Contact in the Corporate Directory 87
- Personal Directory 87
  - Sign In and Out of a Personal Directory 88

Add a New Contact to Your Personal Directory	88
Search for a Contact in Your Personal Directory	88
Call a Contact in Your Personal Directory	89
Assign a Fast-Dial Code to a Contact	89
Call a Contact with a Fast-Dial Code	90
Edit a Contact in Your Personal Directory	90
Remove a Contact from Your Personal Directory	90
Delete a Fast-Dial Code	91
Cisco Web Dialer	91

---

**CHAPTER 4****Recent Calls 93**

Recent Calls List	93
View Your Recent Calls	93
Return a Recent Call	94
Clear the Recent Calls List	94
Delete a Call Record	94

---

**CHAPTER 5****Applications 97**

Available Applications	97
View Active Applications	97
Switch to Active Applications	97
Close Active Applications	98

---

**CHAPTER 6****Settings 99**

Settings Menu	99
Change the Wallpaper	99
Change the Ringtone	99
Adjust the Screen Brightness	100
Adjust the Contrast	100
Change the Font Size	101
Change the Phone Name	101
Video Settings	101
Adjust the Video Brightness	101
Adjust the Video Bandwidth	102

View Video Calls on Your Computer	102
Turn Off the Lower Your Voice Alert	103
Enable Voice Feedback from Accessibility	103
Adjust Voice Speed	104
Turn Off the Select Key LED for Energy Save Mode	104
Associate Your Headset with Your User Information	105
Adjust the Volume During a Call	105
Adjust the Phone Ringer Volume	106
Phone Display Language	106

---

**CHAPTER 7**
**Accessories 107**

Supported Accessories	107
Check Your Phone Model	109
View the Accessories Associated with Your Phone	110
Headsets	110
Important Headset Safety Information	110
Cisco Headset 500 Series	110
Cisco Headset 521 and 522 Controller Buttons and Hardware	114
Cisco Headset 531 and 532 USB Adapter Buttons and Hardware	115
Cisco Headset 561 and 562 Buttons and LED	116
Standard Base for Cisco Headset 561 and 562	117
Multibase for Cisco Headset 560 Series	118
Cisco Headset 700 Series	122
Cisco Headset 730 Buttons and Hardware	122
Cisco Headset 720 Buttons and Hardware	125
Bang & Olufsen Cisco 980 Buttons and Hardware	125
Third Party Headsets	126
Bluetooth Headsets	126
Audio Quality	127
Wired Headsets	127
Wireless Headsets	127
Connect a Headset to Your Phone	127
Connect a Standard Headset	128
Connect a USB Headset	128

Connect a Cisco Standard Base with the Y-Cable	129
Connect the multibase to a Bluetooth device	129
Disconnect the Multibase from a Bluetooth Device	130
Erase all Bluetooth pairings	130
Configure a Headset on the Phone	130
Reset Cisco Headset settings from your phone	130
Adjust the Headset Feedback	131
Turn Bluetooth On or Off	131
Add a Bluetooth Headset	131
Disconnect a Bluetooth Headset	131
Remove a Bluetooth Headset	132
Set Up a Wideband Standard Headset	132
Enable electronic hookswitch control on your phone	132
Cisco Headset Customization	133
Cisco Headset 500 Series Customization	133
Cisco Headset 700 Series Customization	136
Change your headset ringer settings	138
Test Your Microphone	139
Update your Cisco headset firmware with a Cisco IP phone	139
Swap Headsets While on a Call	139
Troubleshoot Your Cisco Headset	140
Confirm that Your Headset Is Registered	140
No Sound in Headset	140
Poor Audio	141
Microphone Not Picking up Sound	141
Headset Not Charging	142
Headset Battery Not Holding a Charge	143
Cisco IP Phone 8800 Key Expansion Module	143
Key Expansion Module Buttons and Hardware	145
Place a Call on the Key Expansion Module	148
Adjust the Key Expansion Module Screen Brightness	148
Silicone Covers	148
Install the Cisco IP Phone Silicone Cover	149
Install the Cisco IP Phone Handset Cover	150



Clean the Silicone Cover 151

---

**CHAPTER 8**

**Product Safety and Security 153**

Safety and Performance Information 153

Power Outage 153

Regulatory Domains 153

Health-Care Environments 153

External Devices 153

Bluetooth Wireless Headset Performance 154

Ways to Provide Power to Your Phone 154

Phone Behavior During Times of Network Congestion 154

UL Warning 155

EnergyStar 155

Product Label 155

Compliance Statements 155

Compliance Statements for the European Union 155

CE Marking 155

RF Exposure Statement for the European Union 156

Compliance Statements for the USA 156

Part 15 Radio Device 156

Compliance Statements for Canada 156

Canadian RF Exposure Statement 156

Canadian High-Power Radars Statement 157

Compliance Statements for New Zealand 157

Permit to Connect (PTC) General Warning 157

Compliance Statements for Taiwan 158

DGT Warning Statement 158

Low Power and Visual Warning Notices 158

Compliance Statement for Argentina 158

Compliance Information for Brazil 158

Compliance Statement for Singapore 159

Compliance Information for Japan 159

FCC Compliance Statements 159

FCC Part 15.19 Statement 159

FCC Part 15.21 Statement	159
FCC RF Radiation Exposure Statement	159
FCC Receivers and Class B Digital Statement	159
Cisco Product Security Overview	160
Cisco Circular Economy	160
Important Online Information	161





# CHAPTER 1

## Your Phone

---

- [The Cisco IP Phone 8800 Series, on page 1](#)
- [New and Changed Information, on page 2](#)
- [Phone Setup, on page 10](#)
- [Protect Your Video Phone Camera, on page 18](#)
- [Activate and Sign In to Your Phone, on page 18](#)
- [Self Care Portal, on page 20](#)
- [Buttons and Hardware, on page 22](#)
- [Accessibility Features for the Cisco IP Phone 8800 Series, on page 31](#)
- [Phone Firmware and Upgrades, on page 40](#)
- [Energy Savings, on page 41](#)
- [Phone Line Modes, on page 42](#)
- [Additional Help and Information , on page 43](#)

## The Cisco IP Phone 8800 Series

The Cisco IP Phones 8811, 8841, 8845, 8851, 8851NR, 8861, 8865, and 8865NR deliver easy-to-use, highly secure voice communications.

**Figure 1: The Cisco IP Phone 8800 Series**



394033

The following table shows the major hardware features of the Cisco IP Phone 8800 Series.

**Table 1: Cisco IP Phone 8800 Series Major Features**

Features	8811	8841	8845	8851	8851NR	8861	8865	8865NR
Screen	Grayscale	Color	Color	Color	Color	Color	Color	Color
USB Ports	0	0	0	1	1	2	2	2
Built-in Camera	No	No	Yes	No	No	No	Yes	Yes
Wi-Fi	No	No	No	No	No	Yes	Yes	No
Bluetooth	No	No	Yes	Yes	No	Yes	Yes	No
Cisco Intelligent Proximity	No	No	Yes	Yes	No	Yes	Yes	No

Your phone must be connected to a network and configured to connect to a call control system. The phones support many functions and features, depending on the call control system. Your phone may not have all functions available, based on the way your administrator has set up the phone.

To make or receive a video call, you must use the Cisco IP Phone 8845, 8865, or 8865NR. The other phones in the Cisco IP Phone 8800 Series only support audio calls.

When you add features to your phone, some features require a line button. But each line button on your phone can support only one function (a line, a speed dial, or a feature). If your phone's line buttons are already in use, your phone does not display any additional features.

To check which phone model you have, press **Applications**  and select **Phone information**. The **Model number** field shows your phone model.



---

**Note** You should save the box and packaging for the Cisco IP Phone 8845, 8865, and 8865NR. The cameras on these phones are fragile. If you move the phone, we recommend that you pack the phone into the original box to protect the camera. For more information, see [Protect Your Video Phone Camera, on page 18](#).

---

## Feature Support

This document describes all the features that the device supports. However, not all features may be supported with your current configuration. For information on supported features, contact your administrator.

## New and Changed Information

You can use the information in the following sections to understand what has changed in the document. Each section contains the major changes.

## New and Changed Information for Firmware Release 14.2(1)

The following information is new or changed for Firmware Release 14.2(1).

Feature	New or Changed
Simplified Extension Mobility Login with Cisco Headset 730 USB Adapter	<a href="#">Sign into Extension Mobility with Your Cisco Headset</a> , on page 19 <a href="#">Associate Your Headset with Your User Information</a> , on page 105
Bluetooth Mute Sync for Cisco Headset 700 Series	<a href="#">Cisco Headset 730 Buttons and Hardware</a> , on page 122
New settings for Cisco Headset 500 Series	<a href="#">Standard Base for Cisco Headset 561 and 562</a> , on page 117 <a href="#">Multibase for Cisco Headset 560 Series</a> , on page 118 <a href="#">Change Call Behavior of On Dock or Off Dock</a> , on page 134 <a href="#">Enable Always On Mode</a> , on page 135
New Cisco Headset 720 and 980 Support	<a href="#">Supported Accessories</a> , on page 107 <a href="#">Cisco Headset 700 Series</a> , on page 122 <a href="#">Cisco Headset 720 Buttons and Hardware</a> , on page 125 <a href="#">Bang &amp; Olufsen Cisco 980 Buttons and Hardware</a> , on page 125

## New and Changed Information for Firmware Release 14.1(1)SR2

The following information is new or changed for Firmware Release 14.1(1)SR2.

Feature	New or Changed
Updated the topics for the call history enhancement for hunt group	<a href="#">Recent Calls List</a> , on page 93 <a href="#">View All Calls on Your Phone</a> , on page 73

## New and Changed Information for Firmware Release 14.1(1)

The following information is new or changed for Firmware Release 14.1(1).

Feature	New or Changed
Improved Call Alert for Hunt Group	<a href="#">Answer a Call Within Your Hunt Group</a> , on page 56
Configurable Calling Number Display for Enhanced Line Mode	<a href="#">Enhanced Line Mode</a> , on page 42

Feature	New or Changed
Expanded Speed Dial	Transfer a Call to Another Person, on page 66 Answer a Call from Another Group (Group Pickup), on page 56 Add Another Person to a Call, on page 67
Configurable Delayed PLAR	Make a Call With A Hotline Phone, on page 53
MRA Support for Extension Mobility Login with Cisco Headsets	Sign into Extension Mobility with Your Cisco Headset, on page 19
New settings for the Cisco Headset 730	Set the Cisco Headset 730 Equalizer Set the Cisco Headset 730 Audio Notifications

## New and Changed Information for Firmware Release 14.0(1)

*Table 2: New and Changed Information*

Feature	New or Changed
Hunt Group Enhancements	Recent Calls List, on page 93 View All Calls on Your Phone, on page 73
New Menu Setting for the Cisco Headset 500 Series	Change your headset ringer settings, on page 134
Headset Upgrade Progress Indicator	Update your Cisco headset firmware with a Cisco IP phone, on page 139
Call Park Enhancements	Place a Call on Hold with Call Park, on page 64

## New and Changed Information for Firmware Release 12.8(1)

*Table 3: New and Changed Information for Firmware Release 12.8(1)*

Feature	New or Changed Content
Feature control changes	Mark Your Calls as Spam, on page 58 Turn Off the Lower Your Voice Alert, on page 103
Phone Data Migration	Replace Your Existing Phone with a New Phone, on page 17
Simplify Extension Mobility Login with a Cisco Headset 500 Series	Sign into Extension Mobility with Your Cisco Headset, on page 19 Associate Your Headset with Your User Information, on page 105
Cisco Circular Economy	Cisco Circular Economy, on page 160



## New and Changed Information for Firmware Release 12.7(1)

The following table shows the changes made for Firmware Release 12.7(1).

**Table 4: Cisco IP Phone 8800 User Guide Revisions for Firmware Release 12.7(1)**

Revision	Updated Section
Updated for mark a call as unwanted	<a href="#">Mark Your Calls as Spam, on page 58</a>
Updated for wallpaper support on key expansion modules.	<a href="#">Change the Wallpaper, on page 99</a>
Updated for Lower your voice.	<a href="#">Turn Off the Lower Your Voice Alert, on page 103</a>
Updated for Select Key LED and Energy Savings.	<a href="#">Energy Savings, on page 41</a> <a href="#">Turn Off the Select Key LED for Energy Save Mode, on page 104</a>
Updated for E-hook.	<a href="#">Enable electronic hookswitch control on your phone, on page 132</a>
Updated for Cisco Headset 730 support	<a href="#">Headsets, on page 110</a> <a href="#">Supported Accessories, on page 107</a> <a href="#">Cisco Headset 700 Series, on page 122</a> <a href="#">Cisco Headset 730 Buttons and Hardware, on page 122</a> <a href="#">Cisco Headset Customization, on page 133</a> and subsections for <a href="#">Cisco Headset 700 Series Customization, on page 136</a>
Updated for hunt group calls on Call Alert	<a href="#">Answer a Call Within Your Hunt Group, on page 56</a>
Cisco Headset 500 Series Firmware Release 1.5 Change	<a href="#">Erase all Bluetooth pairings, on page 130</a>
General changes	In certain circumstances, users who dialed a number that was busy received the reorder tone. With this release, the user hears the busy tone.  Updated the LED states, based on the line mode: <a href="#">Softkey, Line, and Feature Buttons, on page 25</a>  New section <a href="#">Phone Icons, on page 26</a>  Updated <a href="#">Enhanced Line Mode, on page 42</a> for string change.

## New and Changed Information for Firmware Release 12.6(1)

All references into Cisco Unified Communications Manager documentation have been updated to support all Cisco Unified Communications Manager releases.

The following table shows the changes made for Firmware Release 12.6(1).

**Table 5: Cisco IP Phone 8800 User Guide Revisions for Firmware Release 12.6(1)**

Revision	Updated Section
Updated for improved Session line mode	<a href="#">Normal Line Mode, on page 42</a>
Updated for improved Enhanced line mode	<a href="#">Enhanced Line Mode, on page 42</a>

## New and Changed Information for Firmware Release 12.5(1)SR3

All references into Cisco Unified Communications Manager documentation have been updated to support all Cisco Unified Communications Manager releases.

The following table shows the changes made for Firmware Release 12.5(1)SR3.

**Table 6: Cisco IP Phone 8800 User Guide Revisions for Firmware Release 12.5(1)SR3**

Revision	Updated Section
Added support for Reset Headset Settings	<a href="#">Reset Cisco Headset settings from your phone, on page 130</a>
New topic	<a href="#">Phone Keypad Characters, on page 24</a>
New topic	<a href="#">Share a Network Connection with Your Phone and Computer, on page 12</a>
New topic	<a href="#">Protect Your Video Phone Camera, on page 18</a>

## New and Changed Information for Firmware Release 12.5(1)SR2

No user guide updates were required for Firmware Release 12.5(1)SR2.

Firmware Release 12.5(1)SR2 replaces Firmware Release 12.5(1) and Firmware 12.5(1)SR1. Firmware Release 12.5(1) and Firmware Release 12.5(1)SR1 have been deferred in favor of Firmware Release 12.5(1)SR2.

## New and Changed Information for Firmware Release 12.5(1)SR1

The following table describes changes to this book to support Firmware Release 12.5(1)SR1.

**Table 7: Cisco IP Phone 8800 User Guide revisions for Firmware Release 12.5(1)SR1.**

Revision	Updated Section
Cisco Headset 561 and 562	<a href="#">Cisco Headset 500 Series, on page 110</a>

Revision	Updated Section
Cisco Headset 561 and 562 Multibase	<a href="#">Multibase for Cisco Headset 560 Series, on page 118</a>
Whisper Paging on Cisco Unified Communications Manager Express	<a href="#">Intercom Calls, on page 69</a>
Chinese Language Support	<a href="#">Chinese Language Support, on page 29</a>
Connect with Activation Code Onboarding	<a href="#">Connect with Activation Code Onboarding, on page 14</a>
Disable handset so audio path can be kept on headset	<a href="#">Audio Path Selection, on page 47</a>

## New and Changed Information for Firmware Release 12.1(1)SR1

The following table describes changes to this book to support Firmware Release 12.1(1)SR1.

**Table 8: Cisco IP Phone 8800 User Guide revisions for Firmware Release 12.1(1)SR1.**

Revision	Updated Section
Updated for Simplified Line Label and Incoming Calls in Enhanced Line Mode.	<a href="#">Enhanced Line Mode, on page 42</a>
Updated for Cisco Wallpaper on Key Expansion Modules.	<a href="#">Cisco IP Phone 8800 Key Expansion Module, on page 143</a>

## New and Changed Information for Firmware Release 12.1(1)

The following table describes changes to this book to support Firmware Release 12.1(1).

**Table 9: Cisco IP Phone 8800 User Guide revisions for Firmware Release 12.1(1).**

Revision	Updated Section
Updated for Cisco Headset 521 and 522.	<a href="#">Cisco Headset 500 Series, on page 110 and Cisco Headset 521 and 522 Controller Buttons and Hardware, on page 114</a>
Updated for Call History.	<a href="#">View Your Recent Calls, on page 93</a>
Added for Accessibility enhancements	<a href="#">Accessibility Features for the Cisco IP Phone 8800 Series, on page 31</a> and the included sections such as <a href="#">Voice Feedback, on page 37</a> <a href="#">Enable Voice Feedback from Accessibility, on page 103</a> <a href="#">Adjust Voice Speed, on page 104</a>

Revision	Updated Section
Updated for Incoming Call Notifications and Call Alert.	<a href="#">Enhanced Line Mode, on page 42</a>
Updated for Cisco Headset 531 and Cisco Headset 532.	<a href="#">Cisco Headset 500 Series, on page 110</a> <a href="#">Test Your Microphone , on page 139</a> <a href="#">Adjust Your Speaker Sidetone, on page 133</a> <a href="#">Adjust Your Bass and Treble, on page 133</a> <a href="#">Adjust Your Microphone Volume, on page 134</a>
Updated for Speed Dial navigation.	<a href="#">Make a Call with a Speed-Dial Button, on page 50</a>
Updated for Speed Dial Button.	<a href="#">Add a Speed Dial Button from Your Phone, on page 51</a> <a href="#">Modify a Speed Dial Button from Your Phone, on page 51</a> <a href="#">Delete a Speed Dial Button from Your Phone, on page 52</a>

## New and Changed Information for Firmware Release 12.0(1)

The following table describes changes to this book to support Firmware Release 12.0(1).

*Table 10: Cisco IP Phone 8800 User Guide revisions for Firmware Release 12.0(1).*

Revision	Updated Section
Updated for new key expansion module	<a href="#">Cisco IP Phone 8800 Key Expansion Module, on page 143</a>

## New and Changed Information for Firmware Release 11.7(1)

The following table describes changes to this book to support Firmware Release 11.7(1).

*Table 11: Cisco IP Phone 8800 User Guide revisions for Firmware Release 11.7(1).*

Revision	Updated Section
Updated for video call enhancements	<a href="#">Video Calls, on page 60</a>
Updated for new user experience	<a href="#">Badged Icons, on page 28</a> <a href="#">Phone Screen Features, on page 26</a> <a href="#">Enhanced Line Mode, on page 42</a>

## New and Changed Information for Firmware Release 11.5(1)SR1

The following table describes changes to this book to support Firmware Release 11.5(1)SR1.

**Table 12: Cisco IP Phone 8800 User Guide revisions for Firmware Release 11.5(1)SR1.**

Revision	Updated Section
Updated for Cisco IP Phone 8865NR support	<a href="#">The Cisco IP Phone 8800 Series, on page 1</a> <a href="#">Set Up Wi-Fi Client, on page 12</a> <a href="#">Buttons and Hardware, on page 22</a> <a href="#">Supported Accessories, on page 107</a>
Updated for Video with Closed Shutter	<a href="#">Stop Your Video, on page 61</a>
Updated for MLPP and Do not disturb support	<a href="#">Turn On Do Not Disturb, on page 55</a> <a href="#">Prioritized Calls, on page 71</a> <a href="#">Answer a Priority Call, on page 72</a>
Updated for Wi-Fi sign support	<a href="#">Set Up Wi-Fi Client, on page 12</a> <a href="#">Connect to a Preconfigured Wi-Fi Network, on page 13</a>

## New and Changed Information for Firmware Release 11.5(1)

The following table describes changes to this book to support Firmware Release 11.5(1).

**Table 13: Cisco IP Phone 8800 User Guide revisions for Firmware Release 11.5(1).**

Revision	Updated Section
Updated the following sections for Enhance Line Mode.	<ul style="list-style-type: none"> <li>• <a href="#">Differences Between Phone Calls and Lines , on page 28.</a></li> <li>• <a href="#">Ignore a Call, on page 54.</a></li> <li>• <a href="#">Decline a Call, on page 54.</a></li> <li>• <a href="#">Phone Line Modes, on page 42.</a></li> <li>• <a href="#">Normal Line Mode, on page 42.</a></li> <li>• <a href="#">Enhanced Line Mode, on page 42.</a></li> </ul>
Added the following section for Postpone a Phone Upgrade	<a href="#">Phone Firmware and Upgrades, on page 40</a>
Revised the following section for Do Not Disturb	<a href="#">Turn On Do Not Disturb, on page 55</a>

Revision	Updated Section
Added Connect to a Pre-Configured Wi-Fi Network	<a href="#">Connect to a Preconfigured Wi-Fi Network, on page 13</a>

## New and Changed Information for Firmware Release 11.0

The following table describes changes to this book to support Firmware Release 11.0.

*Table 14: Cisco IP Phone 8800 User Guide revisions for Firmware Release 11.0.*

Revision	Updated Section
Removed references to specific font size.	<a href="#">Change the Font Size, on page 101.</a>
Updated the following section for improved Barge and Merge support.	<a href="#">Add Yourself to a Call on a Shared Line, on page 75</a>
Revised the following section for the improved Problem Report Tool support.	<a href="#">Report All Phone Issues , on page 44</a>
Added new icon to the following section for Do Not Disturb(DND).	<a href="#">Turn On Do Not Disturb, on page 55</a>
Updated the following section for Welcome screen.	<a href="#">Connect to Expressway, on page 15</a>

## Phone Setup

Your administrator sets up your phone and connects it to the network. If your phone is not set up and connected, contact your administrator for instructions.

### Adjust the Handset Rest

If your phone is wall-mounted or if the handset slips out of the cradle too easily, you may need to adjust the handset rest to ensure that the receiver does not slip out of the cradle.

Figure 2: Adjust the Handset Rest

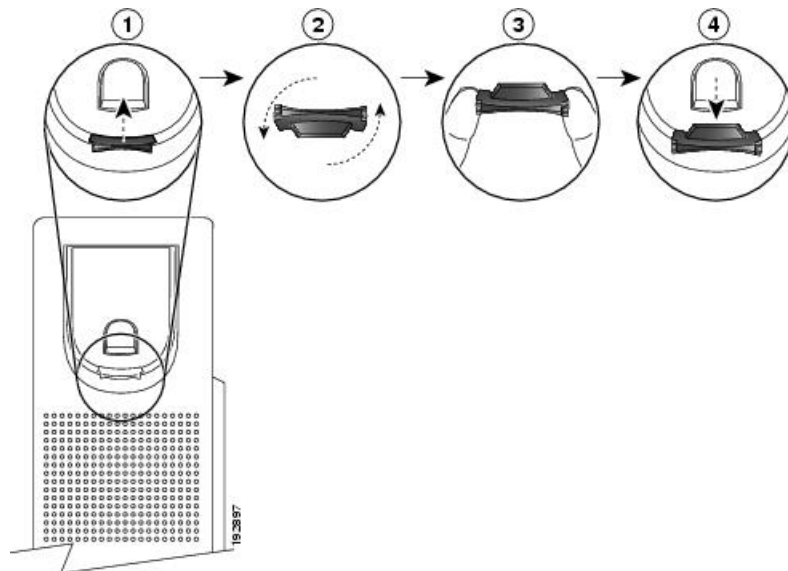

### Procedure

- 
- Step 1** Remove the handset from the cradle and pull the plastic tab from the handset rest.
  - Step 2** Rotate the tab 180 degrees.
  - Step 3** Hold the tab between two fingers, with the corner notches facing you.
  - Step 4** Line up the tab with the slot in the cradle and press the tab evenly into the slot. An extension protrudes from the top of the rotated tab.
  - Step 5** Return the handset to the handset rest.
- 

## Change the Viewing Angle of Your Phone

You can change the angle of the phone to eliminate glare on the screen. If your phone has a video camera, you can change the angle to improve the camera view.

### Procedure

- 
- Step 1** Hold the receiver in the cradle with one hand.
  - Step 2** Move the footstand with the other hand to change the angle.
  - Step 3** (Optional) Adjust the footstand on the key expansion module and ensure that the phone and key expansion module are stable.
  - Step 4** (Optional) Press **Self-view** to check the camera angle.
-



## Connect to the Network

You need to connect the phone to the network.

- Wired network connection—The phone is plugged into the network with an Ethernet cable.
- Wireless connection—The Cisco IP Phone 8861 and 8865 can connect to a Wireless Access Point using Wi-Fi.

After connecting the phone to the network, your phone may be set up for:

- Virtual Private Network (VPN)—Your phone connects to a protected network.
- Mobile and Remote Access Through Expressway—If your administrator sets up Mobile and Remote Access Through Expressway and you connect your phone to the network, it connects to the Expressway server.

## Share a Network Connection with Your Phone and Computer

Both your phone and your computer must connect to your network to function. If you only have one Ethernet port, then your devices can share the network connection.

### Before you begin

Your administrator must enable the PC port in Cisco Unified Communications Manager before you can use it.

### Procedure

- 
- Step 1** Connect the phone SW port to the LAN with an Ethernet cable.
  - Step 2** Connect your computer to the phone PC port with an Ethernet cable.
- 

## Set Up Wi-Fi Client

The Cisco IP Phone 8861 and 8865 can access a Wi-Fi network. You need a power adapter to power the phone. The Cisco IP Phone 8865NR cannot be used with a Wi-Fi network.

The Cisco IP Conference Phone 8832 can access a Wi-Fi network. You need a power adapter to power the phone. The Cisco IP Conference Phone 8832NR cannot be used with a Wi-Fi network.



---

**Note** The phone PC port is disabled when Wi-Fi is enabled on your phone.

---

### Before you begin

Your administrator needs to configure settings on the call control system to enable Wi-Fi access.

### Procedure

---

- Step 1** If the phone is plugged into the Ethernet, unplug the Ethernet cable.
- Step 2** Press **Applications** .
- Step 3** Press **Settings**.
- Step 4** Navigate to **Admin settings** > **Network setup** > **Wi-Fi client setup** > **Wi-Fi sign in access**.
- Step 5** Navigate to **Admin settings** > **Network setup** > **Wi-Fi client setup**.
- Step 6** Navigate to **Wireless** and press **On**.
- Step 7** Navigate to **Wi-Fi sign in access** and press **On**.
- Step 8** Press **Apply** to save the changes, or press **Revert** to cancel the changes.
- Step 9** Navigate to **Network name**.
- Step 10** When the phone finishes scanning the SSID, choose a network to join.
- Step 11** Enter your Wi-Fi credentials and press **Connect**.
- 

## Connect to a Preconfigured Wi-Fi Network

You can connect to a Wi-Fi network with your Cisco IP Phone 8861 and 8865. But the Cisco IP Phone 8865NR does not support Wi-Fi.

Depending upon how your phone is configured, you could be required to sign in when you join a Wi-Fi network or when your phone powers up.

You cannot dismiss the Wi-Fi sign-in window without entering the correct username and password.

### Procedure

---

- Step 1** Enter your Wi-Fi credentials when prompted.
- Step 2** Select **Sign-in**.
- 

## Connect to a VPN

You connect to your VPN in one of two ways:

- By entering credentials (username and password, or just a password)
- With a certificate

If you have a certificate installed on your phone, you do not need to do anything. Your phone automatically connects to the VPN.

### Procedure

---

- Step 1** When prompted, enter your VPN credentials.

**Step 2** Select **Sign-in**.

---

## Set up a Phone for Use with VPN

### Before you begin

To complete this procedure, you must have a valid TFTP server address. If you do not have this information, contact your administrator.

You cannot use the Wi-Fi client with the Cisco IP Phone 8865NR.

### Procedure

---

**Step 1** Press **Applications** .

**Step 2** Select **Admin settings**.

**Step 3** Select one of the following menu items:

- All phones connected to the Ethernet: **Ethernet setup**
- Cisco IP Phone 8861 and 8865 users that use Wi-Fi: **Network setup > Wi-Fi client setup**

**Step 4** Select **IPv4 Setup**.

**Step 5** Navigate to **Alternate TFTP** and choose **On**.

**Step 6** Select **TFTP server 1**.

**Step 7** Enter your TFTP server address in the **TFTP server 1** field.

**Step 8** Press **Apply**.

**Step 9** Press **Continue**.

**Step 10** Press **Exit**.

---

## Connect with Activation Code Onboarding

If your network has been configured to support this feature, then you can use Activation Code Onboarding to connect to your company's phone network.

### Enter an Activation Code

Activation codes are used to set up your new phone. They can only be used once, and expire after 1 week. Contact your administrator if you don't know your code or if you need a new one.

### Procedure

---

**Step 1** Enter your activation code on the activation screen.

**Step 2** Press **Submit**.

---

## Activate Your Phone with a QR Code

If your phone has a camera, you can scan a QR code to activate the phone. If you inadvertently press **Enter** manually, press **Back**  to return to the QR code screen.

### Before you begin

You need the QR code for your phone. If you are assigned to a phone, then the code is available on the Self Care Portal. But your administrator may have blocked you from viewing this information.

Codes are valid for up to 1 week by default, and have an expiry date near the bottom of the graphic. If the code has expired or if you need a code, then contact your administrator.

### Procedure

---

- Step 1** Make the QR code ready with one of these methods:
- Print the email with the QR code and hold the paper in front of the phone camera.
  - Display the QR code on your mobile device and hold the device in front of the phone camera.
- Step 2** Turn the ring around the camera clockwise to open the shutter.
- Step 3** Scan the QR code.  
When the scan succeeds, your phone registers with the server, and you're ready to make your first call.
- 

## Connect to Expressway

You can use Mobile and Remote Access Through Expressway to connect into your corporate network when you are working away from your office. Because your phone does not have a TFTP address configured, the phone displays a Welcome screen to begin the sign-in process.

You can use Mobile and Remote Access Through Expressway to connect to your corporate network when you are working away from your office.

### Before you begin

If you have been using your phone at the office or with a VPN, reset your service mode before you connect to Expressway.

If you need to connect to Mobile and Remote Access Through Expressway on-premise, restart your phone and press **Select** when prompted.

### Procedure

---

- Step 1** Reset service mode through **Settings > Admin Settings > Reset Settings > Service mode**.
- Step 2** Press **Select** when prompted to change the service mode.
- Step 3** Enter your activation code or service domain on the **Welcome** screen and press **Continue**.
- Step 4** Enter the service domain and press **Continue**.
- Step 5** Enter your username and password.
- Step 6** Press **Submit**.

**Step 7** Select **Sign in**.**Activate Your Phone Automatically with a QR Code**

If your phone has a camera, you can scan a QR code to activate the phone. If you inadvertently press **Enter** manually, press **Back**  to return to the QR code screen.

**Before you begin**

You need the QR code from your welcome message.

If the code from your welcome message has expired, generate an activation code for your device with the Self Care portal or request an activation code from your administrator.

**Procedure**

**Step 1** Make the QR code ready with one of these methods:

- Print the email with the QR code and hold the paper in front of the phone camera.
- Display the QR code on your mobile device and hold the device in front of the phone camera.
- Display the QR code on your computer and hold the phone in front of the computer screen.

**Step 2** Turn the ring around the camera clockwise to open the shutter.

**Step 3** Scan the QR code.

When the scan succeeds, your phone registers with the server, and you're ready to make your first call.

**Change the Service Mode**

When your phone connects to the existing server, you hear a beep tone that exists for 5 seconds. You also view an alert message window which indicates that you can change the service mode to Huron.

**Procedure**

**Step 1** To change the service mode:

- Press the **Select** key on the phone.
- Select **Settings** > **Admin Settings** > **Reset Settings** > **Service Mode**.

Your phone deactivates your VPN, and then restarts.

**Step 2** Press **Reset** to change the service to Huron.

**Step 3** Press **Cancel** to retain the existing service.

**Secure the Phone with a Cable Lock**

You can secure your Cisco IP Phone 8800 Series with a laptop cable lock up to 20 mm wide.

### Procedure

---

- Step 1** Take the looped end of the cable lock and wrap it around the object to which you want to secure your phone.
  - Step 2** Pass the lock through the looped end of the cable.
  - Step 3** Unlock the cable lock.
  - Step 4** Press and hold the locking button to align the locking teeth.
  - Step 5** Insert the cable lock into the lock slot of your phone and release the locking button.
  - Step 6** Lock the cable lock.
- 

## Replace Your Existing Phone with a New Phone

You can change your phone model. The change can be required for a number of reasons, for example:

- You have updated your Cisco Unified Communications Manager (Unified CM) to a software version that doesn't support the phone model.
- You want a different phone model from their current model.
- Your phone requires repair or replacement.

**Limitation:** If the old phone has more lines or line buttons than the new phone, the new phone doesn't have the extra lines or line buttons configured.

The phone reboots when the configuration is complete.

### Before you begin

Your administrator needs to set up Cisco Unified Communications Manager to enable the phone migration.

You need a new phone that hasn't been connected to the network or previously configured.

### Procedure

---

- Step 1** Power off the old phone.
  - Step 2** Power on the new phone.
  - Step 3** If prompted, enter your activation code.
  - Step 4** Select **Replace an existing phone**.
  - Step 5** Enter the primary extension of the old phone.
  - Step 6** If the old phone had a PIN assigned, enter the PIN.
  - Step 7** Press **Submit**.
  - Step 8** If you have several devices, select the device to replace from the list and press **Continue**.
-

## Protect Your Video Phone Camera

The camera on your video phone is fragile and could break during transportation of the phone.

### Before you begin

You need one of these:

- Original phone box and the packing material
- Packaging material, such as foam or bubble wrap

### Procedure

---

- Step 1** If you have the original box:
- Place the foam on the camera in such a way that the lens is well-protected.
  - Place the phone in its original box.
- Step 2** If you do not have the box, carefully wrap the phone with foam or bubble wrap to protect the camera. Ensure that the foam protects and surrounds the camera so that nothing can press against the camera from any direction or the camera may be damaged in transport.
- 

## Activate and Sign In to Your Phone

You may need to activate or sign in to your phone. Activation happens once for your phone, and connects the phone to the call control system. Your administrator gives you your sign-in and activation credentials.

### Sign In to Your Phone

#### Before you begin

Get your user ID and PIN or password from your administrator.

#### Procedure

---

- Step 1** Enter your user ID in the **User ID** field.
- Step 2** Enter your PIN or password in the **PIN** or **Password** field, then press **Submit**.
- 

### Sign In to Your Extension from Another Phone

You can use Cisco Extension Mobility to sign in to a different phone in your network and have it act the same as your phone. After you sign in, the phone adopts your user profile, including your phone lines, features,



established services, and web-based settings. Your administrator sets you up for the Cisco Extension Mobility service.

### Before you begin

Get your user ID and PIN from your administrator.

### Procedure

---

- Step 1** Press **Applications** .
  - Step 2** Press **Apps**.
  - Step 3** Select **Extension Mobility** (name can vary).
  - Step 4** Enter your user ID and PIN.
  - Step 5** If prompted, select a device profile.
- 

## Sign Out of Your Extension from Another Phone

### Procedure

---

- Step 1** Press **Applications** .
  - Step 2** Press **Apps**.
  - Step 3** Select **Extension Mobility**.
  - Step 4** Press **Yes** to sign out.
- 

## Sign into Extension Mobility with Your Cisco Headset

You can use Cisco Extension Mobility to sign in to a different phone in your network and have it act the same as your phone. After you sign in, the phone adopts your user profile, including your phone lines, features, established services, and web-based settings. Your administrator sets you up for the Cisco Extension Mobility service.

Headset sign-in is supported for Mobile and Remote Access (MRA).

When your phone is connected with Mobile and Remote Access, you don't get the sign-in screen.

You plug your Cisco Headset 500 Series or Cisco Headset 730 into someone else's phone. The headsets need to use the USB or Y-cable to access this feature, or be paired and connected to the phone through the Cisco Headset 560 Series Standard Base or Cisco Headset 560 Series Multibase. The Cisco Headset 730 needs to connect to the phone with the USB cable, or be paired and connected to the phone through the Cisco Headset USB HD Adapter.

If your headset is not mapped to your user ID, the first time you perform this procedure, phone may prompt you to map the headset to your ID and the Cisco Unified Communications Manager maps the headset to your user record. The prompt depends on configuration settings for the phone. When your headset is mapped to

you, the phone gets your user ID, based on the headset serial number, and displays your ID in the Extension Mobility sign-in screen.



---

**Note** If the headset is upgrading or you're on a call, the association can't be made. Wait until the upgrade is finished or the call is finished before you perform this procedure.

---

When you unplug the headset or the USB adapter, you are signed out of Extension Mobility after a delay unless you confirm the sign-out.

If you move your wireless headset too far from the phone, the phone signs you out of Extension Mobility after a predetermined inactivity time.

You are also automatically signed out of Extension Mobility after a predetermined inactivity time.

### Before you begin

A headset firmware upgrade can't be in progress.

The phone must be idle.

### Procedure

---

- Step 1** Plug your headset into the phone.
- Step 2** If prompted, enter your user ID and PIN to map the headset to your user information.  
If the headset has been already associated with another user, choose **Yes** to sign the user out.
- Step 3** In the Extension Mobility screen, enter your user ID and PIN, and press **Submit**.
- Step 4** If prompted, select a device profile.
- Step 5** When finished, unplug your headset.
- Step 6** Press **Sign out**.

---

### Related Topics

[Associate Your Headset with Your User Information](#), on page 105

## Self Care Portal

You can customize some phone settings with the Self Care portal web site, which you access from your computer. The Self Care portal is part of your organization's Cisco Unified Communications Manager.

Your administrator gives you the URL to access the Self Care portal, and provides your user ID and password.

In the Self Care portal, you can control features, line settings, and phone services for your phone.

- Phone features include speed dial, do not disturb, and your personal address book.
- Line settings affect a specific phone line (directory number) on your phone. Line settings can include call forwarding, visual and audio message indicators, ring patterns, and other line-specific settings.

- Phone services can include special phone features, network data, and web-based information (such as stock quotes and movie listings). Use the Self Care Portal to subscribe to a phone service before you access it on your phone.

If you use a Cisco IP Phone 8800 Key Expansion Module, then you can configure it for speed dial and other phone services.

The following table describes some specific features that you configure with the Self Care portal. For more information, see the Self Care portal documentation for your call control system.

**Table 15: Features Available on the Self Care Portal**

Features	Description
Call forward	Use the number that receives calls when call forward is enabled on the phone. Use the Self Care portal to set up more complicated call forward functions, for example, when your line is busy.
Additional phones	Specify the additional phones such as your mobile phone that you want to use to make and receive calls with the same directory numbers as your desk phone. You can also define blocked and preferred contacts to restrict or allow calls from certain numbers to be sent to your mobile phone. When you set up additional phones, you can also set up these features: <ul style="list-style-type: none"> <li>• Single number reach—Specify whether the additional phone should ring when someone calls your desk phone.</li> <li>• Mobile calls—If the additional phone is a mobile phone, you can set it up to allow you to transfer mobile calls to your desk phone or desk phone calls to your mobile phone.</li> </ul>
Speed dial	Assign phone numbers to speed-dial numbers so that you can quickly call that person.

#### Related Topics

[Phone Calls with Mobile Connect](#), on page 81

[Speed Dial](#), on page 49

[Forward Calls](#), on page 66

## Speed-Dial Numbers

When you dial a number on your phone, you enter a series of digits. When you set up a speed-dial number, the speed-dial number must contain all the digits you need to make the call. For example, if you need to dial 9 to get an outside line, you enter the number 9 and then the number you want to dial.

You can also add other dialed digits to the number. Examples of additional digits include a meeting access code, an extension, a voicemail password, an authorization code, and a billing code.

The dial string can contain the following characters:

- 0 to 9
- Pound (#)
- Asterisk (\*)

- Comma (,)—This is the pause character, and gives a 2 second delay in the dialing. You can have several commas in a row. For example, two commas (,,) represent a pause of 4 seconds.

The rules for dial strings are:

- Use the comma to separate the parts of the dial string.
- An authorization code must always precede a billing code in the speed-dial string.
- A single comma is required between the authorization code and the billing code in the string.
- A speed-dial label is required for speed dials with authorization codes and additional digits.

Before you configure the speed dial, try to dial the digits manually at least once to ensure that the digit sequence is correct.

Your phone does not save the authorization code, billing code, or extra digits from the speed dial in the call history. If you press **Redial** after you connect to a speed-dial destination, the phone prompts you to enter any required authorization code, billing code, or additional digits manually.

### Example

To set up a speed-dial number to call a person at a specific extension, and if you need an authorization code and billing code, consider the following requirements:

- You need to dial **9** for an outside line.
- You want to call **5556543**.
- You need to input the authorization code **1234**.
- You need to input the billing code **9876**.
- You must wait for 4 seconds.
- After the call connects, you must dial the extension **56789#**.

In this scenario, the speed-dial number is **95556543,1234,9876,,56789#**.

### Related Topics

[Calls That Require a Billing Code or Authorization Code](#), on page 53

[Phone Keypad Characters](#), on page 24

## Buttons and Hardware

The Cisco IP Phone 8800 Series has two distinct hardware types:

- Cisco IP Phones 8811, 8841, 8851, 8851NR, and 8861—do not have a camera.
- Cisco IP Phones 8845, 8865, and 8865NR—have a built-in camera.





The following figure shows the Cisco IP Phone 8845.











Figure 3: Cisco IP Phone 8845 Buttons and Hardware



The following table describes the Cisco IP Phone 8800 Series Buttons.

Table 16: Cisco IP Phone 8800 Series Buttons

1	Handset and Handset light strip	Indicates whether you have an incoming call (flashing red) or a new voice message (steady red).
2	Camera Cisco IP Phone 8845, 8865, and 8865NR only	Use the camera for video calls.
3	Programmable feature buttons and line buttons	 Access your phone lines, features, and call sessions. When adding features to the phone line keys, you are limited by the number of line keys available. You cannot add more features than the number of line keys on your phone. For more information, see the Softkey, Line, and Feature Buttons section in the "Cisco IP Phone Hardware" chapter.
4	Softkey buttons	 Access to functions and services. For more information, see the Softkey, Line, and Feature Buttons section in the "Cisco IP Phone Hardware" chapter.
5	<b>Back</b> , Navigation cluster, and <b>Release</b>	<b>Back</b>  Return to the previous screen or menu. Navigation cluster  Navigation ring and <b>Select</b> button—Scroll through menus, highlight items and select the highlighted item. <b>Release</b>  End a connected call or session.

6	<b>Hold/Resume, Conference, and Transfer</b>	<b>Hold/Resume</b>  Place an active call on hold and resume the held call. <b>Conference</b>  Create a conference call. <b>Transfer</b>  Transfer a call.
7	<b>Speakerphone, Mute, and Headset</b>	<b>Speakerphone</b>  Toggle the speakerphone on or off. When the speakerphone is on, the button is lit. <b>Mute</b>  Toggle the microphone on or off. When the microphone is muted, the button is lit. <b>Headset</b>  Toggle the headset on. When the headset is on, the button is lit. To leave headset mode, you pick up the handset or select <b>Speakerphone</b>  .
8	<b>Contacts, Applications, and Messages</b>	<b>Contacts</b>  Access personal and corporate directories. <b>Applications</b>  Access recent calls, user preferences, phone settings, and phone model information. <b>Messages</b>  Autodial your voice messaging system.
9	<b>Volume button</b>	 Adjust the handset, headset, and speakerphone volume (off hook) and the ringer volume (on hook).

## Phone Keypad Characters

The phone keypad allows you to enter letters, numbers, and special characters. You press the **Two (2)** to **Nine (9)** keys to get the letters and numbers. You use the **One (1)**, **Zero (0)**, **Asterisk (\*)**, and **Pound (#)** keys for special characters. The following table lists the special characters for each key for the English locale. Other locales will have their own characters.

*Table 17: Special Characters on the Keypad*

Keypad Key	Special Characters
<b>One (1)</b>	/ . @ : ; = ? - _ & %
<b>Zero (0)</b>	(space) , ! ^ ' "
<b>Asterisk (*)</b>	+ * ~ ` < >
<b>Pound (#)</b>	# \$ £ □ \ ( ) { } [ ]

## Navigation

Use the outer ring of the Navigation cluster to scroll through menus and to move between fields. Use the inner **Select** button of the Navigation cluster to select menu items.

Figure 4: Navigation Cluster









If a menu item has an index number, you can enter the index number with the keypad to select the item.

## Softkey, Line, and Feature Buttons

You can interact with the features on your phone in several ways:

- Softkeys, located below the screen, give you access to the function displayed on the screen above the softkey. The softkeys change depending on what you are doing at the time. The **More ...** softkey shows you that more functions are available.
- Feature and line buttons, located on either side of the screen, give you access to phone features and phone lines.
  - Feature buttons—Used for features such as **Speed dial** or **Call pickup**, and to view your status on another line.
  - Line buttons—Used to answer a call or resume a held call. When not used for an active call, used to initiate phone functions, such as the missed calls display.

Feature and line buttons illuminate to indicate status.

LED Color and State	Normal Line Mode: Line Buttons	Normal Line Mode: Feature Buttons Enhanced Line Mode
 Green, steady LED	Active call or two-way intercom call, held call, privacy in use	Active call or two-way intercom call, privacy in use
 Green, flashing LED	Not applicable	Held call
 Amber, steady LED	Incoming call, reverting call, one-way intercom call, logged into a Hunt Group	One-way intercom call, logged into a Hunt Group
 Amber, flashing LED	Not applicable	Incoming call, reverting call
 Red, steady LED	Remote line in use, Remote line on hold, Do Not Disturb active	Remote line in use, Do Not Disturb active
 Red, flashing LED	Not applicable	Remote line on hold

Your administrator can set up some functions as softkeys or as feature buttons. You can also access some functions with softkeys or the associated hard button.

**Related Topics**

[Phone Line Modes](#), on page 42

## Phone Screen Features

The phone screen shows information about your phone such as directory number, active call and line status, softkeys, speed dials, placed calls, and phone menu listings. The screen is made up of three sections: the header row, the middle section, and the footer row.

**Figure 5: Cisco IP Phone 8800 Screen**

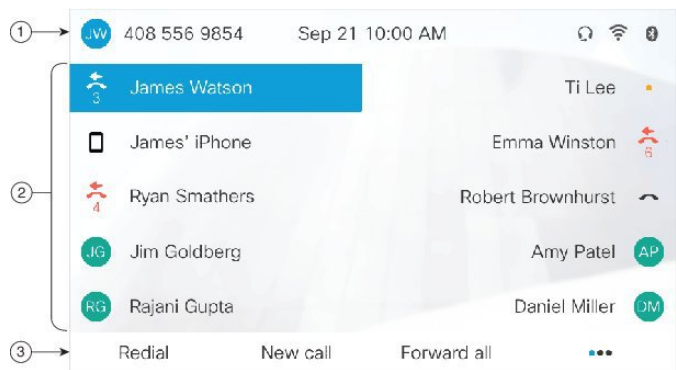

The following table describes the Cisco IP Phone screen components.

**Table 18: Cisco IP Phone Screen Information**

1	At the top of the screen is the header row. The header row displays the phone number, current date and time, as well a number of icons. The icons display when features are active.
2	The middle of the phone screen displays the information associated with the line and feature buttons on the phone.
3	The bottom row of the screen contains the softkey labels. Each label indicates the action for the softkey button below the screen.

## Phone Icons



Your phone screen displays many icons. This section gives images of the common icons

Icons are in color or grayscale, depending on the screen.



### Lines

Icon	Description
	Line/Directory Number
	Speed dial
	Intercom





Icon	Description
	Held call
	Active call

### Shared Lines

Icon	Description
	Incoming call on shared line.
	Shared line active by another user.



### Recents

Icon	Description
	Incoming call
	Outgoing call
	Missed call

### Bluetooth Icons

If your phone model supports Bluetooth, you see these icons.





*Table 19: Bluetooth Icons*

Icon	Description
	Bluetooth is turned on.
	A device is connected with Bluetooth.
	Bluetooth is turned on but no device is connected.

### Wi-Fi Network Icons

If your phone is connected to the Wi-Fi network, you see these icons.

Table 20: Network Icons

Icon	Description
   	Wi-Fi connected and the number of bars indicates the signal strength.
	There is no Wi-Fi connection

## Clean the Phone Screen

### Procedure

---

If your phone screen gets dirty, wipe it with a soft, dry cloth.

**Caution** Do not use any liquids or powders on the phone because they can contaminate the phone components and cause failures.

---

## Badged Icons

If you have missed calls, the missed call icon, and a counter showing the number of missed calls, display on your phone desktop. If you receive a voicemail, the missed call icon changes to the voicemail icon and voicemail counter until you listen to your messages.

In addition, if you have more than one call on a line, either the held icon or the off hook icon change to show the number of calls.

## Differences Between Phone Calls and Lines

We use the terms *lines* and *calls* in very specific ways to explain how to use your phone.

- **Lines**—Each line corresponds to a directory number or intercom number that others can use to call you. You have as many lines as you have directory numbers and phone line icons. Depending upon how your phone is configured, you could have up to 16 lines.
- **Calls**—Each line can support multiple calls. By default, your phone supports four connected calls per line, but your administrator can adjust this number according to your needs.

Only one call can be active at any time; other calls are automatically placed on hold.

Here is an example: If you have two lines and each line supports four calls, then you could have up to eight connected calls at one time. Only one of those calls is active and the other seven are held calls.

## USB Ports

Your phone may have one or more USB ports. Each USB port supports a maximum of five USB devices. Each device connected to the port is included in the maximum device count, including any Key Expansion Modules.

For example, your phone can support five USB devices on the side port and five additional standard USB devices on the back port. Many third-party USB products contain more than one USB device, and thus count as more than one device.

If you use a USB hub and remove the USB cable from the phone during an active call, your phone might restart.

### Related Topics

[The Cisco IP Phone 8800 Series](#), on page 1

## Mobile Device Charging

You can use the USB ports on your phone to charge your mobile device if the device has a USB connection. The following ports support USB charging:

- Side port—Provides standard device charging.
- Back port (Cisco IP Phone 8861, 8865, and 8865NR only)—Provides standard device charging as well as fast-charging.

Your phone continues to charge the mobile device while it is in power-saving mode but stops charging in Power Save Plus mode.

When you use your phone to charge your mobile device, the following conditions apply:

- A short delay may occur before charging begins.
- In some situations, your device will not display the charging icon. For example, the icon may not display when the device is fully charged.
- When more than one Cisco IP Phone 8800 Key Expansion Module is attached to your phone, the back USB port cannot fast-charge the device.

If you unplug your tablet and immediately plug in a USB headset to the phone, a 3-second delay occurs before the phone recognizes the USB headset.

### Related Topics

[Energy Savings](#), on page 41

## Chinese Language Support

You can input Chinese characters and have Chinese displays on your phone by selecting 拼音. This feature is supported on speed dial, call history, and personal and corporate directories.

This feature is supported on both the phone and the key expansion modules. But, it is only available in Asian countries and only Chinese (China) is supported. Chinese input is based on the Pinyin input method, which is common to PCs and mobile phones in many Asian countries.

This feature requires the Chinese locale installer, but it does not require any additional configuration.

## Search Call History

Chinese input is based on the Pinyin input method, which is common to PCs and mobile phones in many Asian countries.

### Procedure

---

**Step 1** Press **Applications** .

**Step 2** Select **Recents**.

When the phone is in the idle state, you can also view the Recent calls list by pressing the Navigation cluster up.

**Step 3** Select **ABC**.

**Step 4** Select 拼音.

**Step 5** Use the navigation cluster and the keypad to select your input.

---

## Add a Speed Dial Button from Your Phone

Chinese users can configure a speed dial button from your phone, if you cannot access the Self Care Portal. Chinese input is based on the Pinyin input method, which is common to PCs and mobile phones in many Asian countries.

### Procedure

---

**Step 1** Press and hold a line key for 2 seconds.

**Step 2** Select 拼音.

**Step 3** In the Name field, enter the name of the speed-dial number.

**Step 4** In the Number field, enter the phone number. Include all the digits that are required to complete the call.

**Step 5** Select **Apply** to save your speed-dial number.

---

## Add a New Contact to Your Corporate or Personal Directory

Chinese users can store the contact information for friends, family, or coworkers. Chinese input is based on the Pinyin input method, which is common to PCs and mobile phones in many Asian countries.

### Procedure

---

**Step 1** Press **Contacts** .

**Step 2** Select Personal directory or Corporate directory.

**Step 3** Select 拼音.

**Step 4** Enter first name, last name, and optionally a nickname.

**Step 5** Press **Phones**, enter the phone number along with any required access codes, and then press **Submit**.

---

## Bluetooth and Your Phone

If your phone supports Bluetooth, use a Bluetooth headset and connect your mobile phone or tablet to the phone.

Bluetooth connections work best when you're within 3 to 6 feet (1 to 2 meters) from your phone, but you might be able to be as far away as 66 feet (20 meters). The Bluetooth connection can degrade if you have a barrier (wall, door, window), large metal object, or other electronic devices between your phone and the connected device.

To connect a mobile device or headset to your phone with Bluetooth, start by pairing the device with your phone. You can pair up to 50 mobile devices and Bluetooth headsets with the phone.

After the headset or mobile device is paired, the phone connects to the headset or mobile device when the headset or mobile device is turned on.

When you use a Bluetooth headset and mobile devices with your phone, keep these things in mind:

- The last Bluetooth headset or mobile device connected with the phone is the default device that the phone uses.
- You can connect one mobile device (phone or tablet) and one Bluetooth headset at the same time.
- The phone can connect to only one paired mobile device at a time. If your mobile phone is connected and you turn on your tablet, the tablet connects to the phone and the mobile phone disconnects.
- When your Bluetooth headset and your mobile device are connected to the phone, you cannot use the Bluetooth headset to answer desk phone calls from the mobile device.

### Related Topics

[Pair a Mobile Device with Your Desk Phone](#), on page 77

[The Cisco IP Phone 8800 Series](#), on page 1

## Accessibility Features for the Cisco IP Phone 8800 Series

The Cisco IP Phone 8800 Series provide accessibility features for the blind, and the visually-, hearing-, and mobility-impaired. Because many of these features are standard, they can be used by users with disabilities without requiring any special configuration.

In this document, the term *phone support pages* refers to the web pages that users can access to set up certain features. For Cisco Unified Communications Manager (Release 10.0 and later), these pages are the Self Care Portal. For Cisco Unified Communications Manager (Release 9.1 and earlier), these pages are the User Options web pages.

Cisco is committed to designing and delivering accessible products and technologies to meet the needs of your organization. You can find more information about Cisco and its commitment to accessibility at this URL: <http://www.cisco.com/go/accessibility>

## Hearing-Impaired Accessibility Features

Your phone comes with standard accessibility features that require little or no setup.

**Figure 6: Hearing-Impaired Accessibility Features—Cisco IP Phone 8861 Shown**



The following table describes the hearing-impaired accessibility features on the Cisco IP Phone 8800 Series.

**Table 21: Hearing-Impaired Accessibility Features**

Item	Accessibility Feature	Description
1	Visual message-waiting indicator (handset)	<p>This lighted strip is visible from all angles. Your phone also provides an audible message-waiting indicator.</p> <p>To change the light or the audible voice-message indicator, sign in to the phone support pages and access the message-indicator settings. You can change each setting to on or off.</p> <p>Your administrator can also change your settings.</p>
2	Visual notification of phone state	<ul style="list-style-type: none"> <li>• Toggle the <b>Mute</b> and <b>Speakerphone</b> buttons on and off to indicate the phone state.</li> <li>• Use the <b>Mute</b> button to toggle the microphone on or off. When the microphone is muted, the button is lit.</li> <li>• Use the <b>Speakerphone</b> button to toggle the speakerphone on or off. When the speakerphone is on, the button is lit.</li> </ul>

Item	Accessibility Feature	Description
3	Adjustable ringtone, pitch, and volume	<ul style="list-style-type: none"> <li>• Select <b>Applications &gt; Preferences</b>.</li> <li>• Adjust the volume level for the phone ring. While the handset is in the cradle and the headset and speakerphone buttons are off, press <b>Volume</b> to raise or lower the volume.</li> </ul> <p>Your administrator can also change your settings.</p>
4	Inline-amplifier support (handset)	Cisco IP Phone handsets support third-party inline amplifiers. You attach an amplifier to the handset and cord and it sits between the handset and the IP phone.
5	Hearing aid compatible (HAC) handset	<p>Supports these accessibility features:</p> <ul style="list-style-type: none"> <li>• Hearing-aid compatible.</li> <li>• Magnetic coupling of the hearing aid.</li> <li>• Federal Communications Commission (FCC) loudness requirements for the Americans with Disabilities Act (ADA).</li> <li>• Section 508 loudness requirements, which are met by using industry-standard inline handset amplifiers.</li> </ul>
6	Acoustic coupled TTY and TDD support (handset)	<p>Cisco IP Phones support these TTY and TDD features:</p> <ul style="list-style-type: none"> <li>• Acoustic or direct connect TTYs from industry-leading manufacturers.</li> <li>• Real-time text transmission over phone lines.</li> <li>• Hearing and voice carry over phones (HCO/VCO).</li> <li>• VoIP network operating at G.711.</li> </ul> <p>For information about setting up TTY, contact your administrator.</p>

## Vision-Impaired and Blind Accessibility Features

Your phone comes with standard accessibility features that require little or no setup.

**Figure 7: Vision-Impaired and Blind Accessibility Features—Cisco IP Phone 8861 Shown**



The following table describes the vision-impaired and blind accessibility features on the Cisco IP Phone 8800 Series.

**Table 22: Vision-Impaired and Blind Accessibility Features**

Item	Accessibility Feature	Description
1	High-contrast visual and audible alert of an incoming call	Alerts you to an incoming call. The handset light strip flashes during incoming calls and stays lit when a voicemail message is received.



Item	Accessibility Feature	Description
2	<p>Line, feature, and session buttons on the Cisco IP Phone</p> <ul style="list-style-type: none"> <li>• Line and feature buttons are to the left of the LCD. Session buttons are to the right of the LCD.</li> <li>• For locales that read right to left, such as Arabic, session buttons are on the left and the line and feature buttons are on the right.</li> </ul>	<p>Use line buttons to start, answer, or switch to a call on a particular line.</p> <p>Features, such as speed dial, line status, privacy, do not disturb (DND), and service URLs, can be assigned to feature buttons.</p> <p>Your administrator sets up programmable feature buttons on your phone.</p> <p>Use session buttons to perform tasks, such as answering a call or resuming a held call.</p> <p>Colors indicate your phone's status:</p> <ul style="list-style-type: none"> <li>• Green, steady—Active call or two-way intercom call.</li> <li>• Green, flashing—Held call.</li> <li>• Amber, steady—Privacy in use, one-way intercom call, DND active, or signed in to a hunt group.</li> <li>• Amber, flashing—Incoming call or reverting call.</li> <li>• Red, steady—Remote line in use (shared line or line status).</li> <li>• Red, flashing—Remote line on hold.</li> </ul>
3	<p>Back-lit color LCD screen on the Cisco IP Phone</p> <ul style="list-style-type: none"> <li>• The Cisco IP Phone 8811 has a grayscale LCD with adjustable contrast.</li> </ul>	<p>Allows you to adjust your phone screen's brightness.</p>
4	<p>Softkeys</p> <ul style="list-style-type: none"> <li>• These are large buttons just below the LCD.</li> </ul>	<p>Provide access to special functions. The functions are displayed on the LCD.</p>
5	<p>Navigation Cluster (includes the Navigation ring and the <b>Select</b> button)</p> <ul style="list-style-type: none"> <li>• The Navigation cluster is located just above the keypad.</li> <li>• <b>Back</b> button to the left of the Navigation cluster</li> <li>• <b>Release (End Call)</b> button to the right of the Navigation cluster</li> </ul>	<p>Use the Navigation ring to move up, down, left, and right in the phone LCD. The <b>Select</b> button is in the center of the Navigation cluster.</p> <p>Use the <b>Back</b> button to return to the previous screen or menu.</p> <p>Use the <b>Release (End Call)</b> button to end a call or session.</p>

Item	Accessibility Feature	Description
6	<p><b>Messages</b> button, <b>Applications</b> button, and <b>Contacts</b> button</p> <ul style="list-style-type: none"> <li>• These three large buttons are located to the left of the keypad.</li> <li>• In this group of buttons, the <b>Messages</b> button is the single button in the top row. Below the <b>Messages</b> button, the <b>Applications</b> button is on the left, and the <b>Contacts</b> button is on the right.</li> </ul>	Allow you to easily access your messages, applications, and contacts.
7	<p><b>Hold</b> button, <b>Transfer</b> button, and <b>Conference</b> button</p> <ul style="list-style-type: none"> <li>• These three large buttons are located to the right of the keypad.</li> <li>• In this group, the <b>Hold</b> button is the single button in the top row. Below the <b>Hold</b> button, the <b>Transfer</b> button is on the left, and the <b>Conference</b> button is on the right.</li> </ul>	Allow you to use these functions on your phone.
8	<p><b>Volume</b> key</p> <ul style="list-style-type: none"> <li>• This key is located at the bottom left of the phone.</li> </ul>	<p>Allows you to increase or decrease the ring volume or the sound through the handset, headset, or speakerphone.</p> <p>Press the right side of the rocker key to increase the volume; press the left side of the rocker key to decrease the volume.</p>
9	Standard 12-key layout	Allows you to use existing or familiar key positions. Key 5 has a nib.

Item	Accessibility Feature	Description
10	<p><b>Headset, Speakerphone, and Mute</b> buttons</p> <ul style="list-style-type: none"> <li>• These buttons are located on the bottom right of the phone.</li> <li>• In this group, the <b>Mute</b> button is the single button in the bottom row. Above the <b>Mute</b> button, the <b>Headset</b> button is on the left, and the <b>Speakerphone</b> button is on the right.</li> </ul>	<p>Provide audible notification of the phone state:</p> <ul style="list-style-type: none"> <li>• Toggle the <b>Headset, Mute, and Speakerphone</b> buttons on and off to indicate the phone state.</li> <li>• Use the <b>Headset</b> button to toggle the headset on. When the headset is on, the button is lit. Pick up the handset or select <b>Speakerphone</b>  to leave headset mode.</li> <li>• Use the <b>Mute</b> button to toggle the microphone on or off. When the microphone is muted, the button is lit. When you turn on Mute, your phone beeps once; when you turn off Mute, your phone beeps twice.</li> <li>• Use the <b>Speakerphone</b> button to toggle the speakerphone on or off. When the speakerphone is on, the button is lit.</li> </ul>

### Adjustable Footstand

You can adjust the footstand to provide optimum phone display viewing and easy access to all buttons and keys.

## Voice Feedback

Voice Feedback helps people with vision problems to use their Cisco IP Phone. When enabled, a voice prompt helps you navigate your phone buttons, and to use and configure phone features. The voice also reads out incoming Caller IDs, displayed screens and settings, and button functions.

Here are a few important items to keep in mind as you use this feature.

- Voice Feedback is enabled and disabled with the **Select** button that is located in the center of the Navigation cluster. When the phone is idle, quickly tap **Select** three times to turn this feature on or off. A voice prompt alerts you to the feature status.
- Push a softkey once, and Voice Feedback reads out the feature that is associated with the key. Quickly push the softkey twice to execute the feature.
- Hard keys, such as the Contacts, Applications, and Messages buttons, are treated differently. Push a hard key once, and a voice reads out the screen name followed by the application or setting that is displayed on the phone.

Volume is adjusted with the **Volume** button. To adjust your handset volume, lift the receiver from the cradle, and press **Volume**. If you use a headset, select the **Headset** button, and then **Volume**. If you use the speakerphone, select **Speakerphone** and **Volume**.

You may not hear Voice Feedback if you select the **Headset** button, but don't have a connected headset. Select **Speakerphone** and you hear Voice Feedback again.

When on a call, only you hear Voice Feedback so your privacy is assured. Voice Feedback is only available for English language users. If this feature is not available to you, then it is disabled on your phone.

**Related Topics**

[Enable Voice Feedback from Accessibility](#), on page 103

[Adjust Voice Speed](#), on page 104

**Mobility-Impaired Accessibility Features**

Your phone comes with standard accessibility features that require little or no setup.

To check which phone model you have, press **Applications**  and select **Phone information**. The **Model number** field shows your phone model.

*Figure 8: Mobility-Impaired Accessibility Features—Cisco IP Phone 8861 Shown*



The following table describes the mobility-impaired accessibility features on the Cisco IP Phone 8800 Series.

Table 23: Mobility-Impaired Accessibility Features.

Item	Accessibility Feature	Description
1	Lighted buttons	<p>Allow you to access the following features:</p> <ul style="list-style-type: none"> <li>• Phone lines and intercom lines (line buttons)</li> <li>• Speed-dial numbers (speed-dial buttons, including the speed-dial line status feature)</li> <li>• Web-based services, such as a personal address book</li> <li>• Phone features, such as privacy</li> </ul> <p>Indicate your phone's status:</p> <ul style="list-style-type: none"> <li>• Green, steady—Active call or two-way intercom call</li> <li>• Green, flashing—Held call</li> <li>• Amber, steady—Privacy in use, one-way intercom call, DND active, or signed in to hunt group</li> <li>• Amber, flashing—Incoming call or reverting call</li> <li>• Red, steady—Remote line in use (shared line or Line Status)</li> </ul>
2	Large buttons to access <b>Applications, Messages, Contacts, Hold, Transfer, and Conference</b>	Allow you to easily access your phone applications, voice messages, corporate and personal directories, and calling features.
3	Built-in speakerphone	Indicates whether the speakerphone is on or off. When the speakerphone is on, the button is lit.
4	Tactile-discernible buttons and functions, including a nib on Key 5	Allow you to easily locate your phone's keys. For example, Key 5 has a nib, which you can use to locate other key positions.

## Cisco IP Phone 8800 Series Wall Mount Kit Accessibility

The Cisco IP Phone 8800 Series phones can be mounted on a wall using one of the following wall mount kits:

- Wallmount Kit for Cisco IP Phone 8800 Series—used to mount a single phone on the wall.
- Wallmount Kit for Cisco IP Phone 8800 Series with single KEM—used to mount a single phone with one attached key expansion module on a wall.
- Wallmount Kit for Cisco IP Phone 8800 Video Series—used to mount a single video phone on the wall.

The Wallmount Kit for Cisco IP Phone 8800 Series and Wallmount Kit for Cisco IP Phone 8800 Series with single KEM meet the 307.2 Protrusion Limits section of the Americans with Disabilities Act (ADA) ADAAG requirement for mounting a phone on the wall.

The Wallmount Kit for Cisco IP Phone 8800 Video Series is slightly larger and does not meet the 307.2 Protrusion Limits section of the Americans with Disabilities Act (ADA) ADAAG requirement for mounting a phone on the wall.

The following figure shows a side view of the phone with the wall mount kit installed.

*Figure 9: Side View of the Phone Installed with the Wall Mount Kit*

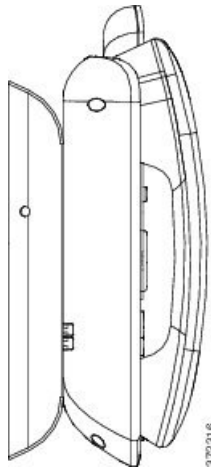

## Phone Firmware and Upgrades

Your phone comes pre-installed with firmware that is specific to the call control system.

Occasionally, your administrator upgrades the phone firmware for you. This upgrade happens in the background even if you are using your phone.

## Postpone a Phone Upgrade

When new firmware is available, the **Ready to upgrade** window is displayed on your phone and a timer begins a 15-second countdown. If you do nothing, the upgrade proceeds.

You can postpone your firmware upgrade for 1 hour and up to 11 times. The upgrade is also postponed if you make or receive a phone call.

### Procedure

---

Select **Delay** to postpone a phone upgrade.

---

## View the Progress of a Phone Firmware Upgrade

During a phone firmware upgrade, you can view the upgrade progress.

### Procedure

---

- Step 1** Press **Applications** .
  - Step 2** Press **Settings**.
  - Step 3** Select **Phone information** > **Show detail**.
  - Step 4** Select **System information** , and press **Show details**.
  - Step 5** Press **Exit**.
- 

## Energy Savings

Your administrator can reduce the amount of power your phone screen uses with the following options:

- **Power Save**—The backlight or screen turns off when the phone is inactive for a set interval.
- **Power Save Plus**—Your phone screen turns on and off at times that are based on your work schedule. If your work hours or work days change, you can contact your administrator to reconfigure your phone.

For example, your administrator can set your phone to alert you 10 minutes before it turns off. You get a message that your phone is turning off soon and you get notifications at these intervals:

- Four rings at 10 minutes before power off
- Four rings at 7 minutes before power off
- Four rings at 4 minutes before power off
- 15 rings at 30 seconds before power off

If your phone is active, it waits until it has been inactive for a set interval before it notifies you of the pending power shutdown.

## Turn On Your Phone

When your phone turns off to save energy, the phone screen is blank and the **Select** button lights up.

### Procedure

---

Press **Select** to turn your phone back on.

---

# Phone Line Modes

Your phone can be set up in one of these modes:

- Normal line mode—In this mode, the buttons to the left and right of the screen have different functions. Usually, the left buttons are the line buttons and the right buttons are the feature buttons. The line and feature buttons are reversed for locales that read from right to left. This mode is also known as session line mode.
- Enhanced line mode—In this mode, the buttons on the left and right of the screen can be set up as line buttons. This mode increases the number of phone lines that you can see and use. You see an alert for an incoming call.

## Related Topics

[Softkey, Line, and Feature Buttons](#), on page 25

## Normal Line Mode

When your phone is set up for normal (Session) line mode, you interact with the phone in these ways:

- Use the New call window to place a call.
- Select **Answer** to answer a call, unless your phone is set up for an Incoming Call alert. If your phone is set up for an Incoming Call alert, select **Answer**, **Decline**, or **Ignore**.
- Five line keys are available. If your phone is connected to your mobile device or tablet with Bluetooth, only four line keys are available.

Firmware release 12.6(1) introduced an improved Session line mode. Now all of your outgoing calls are handled with the primary line unless you select another line. If you have calls on multiple lines, the calls are handled in sequence. When the last call ends, your phone reverts to the primary line.

## Enhanced Line Mode

When your phone is set up for Enhanced line mode, you interact with the phone in these ways:

- Select a phone line and enter the phone number to make calls. The Recents list displays phone numbers similar to the number being dialed.
- Select **Answer**, **Decline**, or **Ignore** to answer calls.
- Ten line keys are available.

You can see your missed calls by selecting a line key to view the missed calls for that line in the call window. The missed call counter clears when you return to the idle screen.

It depends how Enhanced line mode is configured, but you will see the call connected status and the line label with one of the following combinations:

- The name of the person calling, and the line receiving the call.
- The directory number of the person calling, and the line receiving the call.



- The name of the person calling, and their directory number.
- The directory number of the person calling.

Forwarded calls are also identified.

## Additional Help and Information

If you have questions about the functions available on your phone, contact your administrator.

The Cisco website (<https://www.cisco.com>) contains more information about the phones and call control systems.

- For quick start guides and end-user guides in English, follow this link:

<https://www.cisco.com/c/en/us/support/collaboration-endpoints/unified-ip-phone-8800-series/products-user-guide-list.html>

- For guides in languages other than English, follow this link:

<https://www.cisco.com/c/en/us/support/collaboration-endpoints/unified-ip-phone-8800-series/tsd-products-support-translated-end-user-guides-list.html>

- For licensing information, follow this link:

<https://www.cisco.com/c/en/us/support/collaboration-endpoints/unified-ip-phone-8800-series/products-licensing-information-listing.html>

## Accessibility Features

Cisco IP Phones provide accessibility features for the vision impaired, the blind, and the hearing and mobility impaired.

For detailed information about the accessibility features on these phones, see <http://www.cisco.com/c/en/us/support/collaboration-endpoints/unified-ip-phone-8800-series/products-technical-reference-list.html>.

You can also find more information about accessibility at this Cisco website:

<http://www.cisco.com/web/about/responsibility/accessibility/index.html>

## Troubleshooting

You may experience issues related to the following scenarios:

- Your phone cannot communicate with the call control system.
- The call control system has communication or internal problems.
- Your phone has internal problems.

If you experience problems, your administrator can help troubleshoot the root cause of the problem.

## Find Information About Your Phone

Your administrator may ask for information about your phone. This information uniquely identifies the phone for troubleshooting purposes.

### Procedure

---

- Step 1** Press **Applications** .
  - Step 2** Select **System information**.
  - Step 3** Select **Phone information**.
  - Step 4** (Optional) Press **Show detail** to view the active load information.
  - Step 5** Press **Exit**.
- 

## Report Call Quality Issues

Your administrator may temporarily configure your phone with the Quality Reporting Tool (QRT) to troubleshoot performance problems. Depending on the configuration, use the QRT to:

- Immediately report an audio problem on a current call.
- Select a general problem from a list of categories and choose reason codes.

### Procedure

---

- Step 1** Press **Report quality**.
  - Step 2** Scroll and select the item that closely matches your problem.
  - Step 3** Press the **Select** softkey to send the information to your system administrator.
- 

## Report All Phone Issues

You can use the Cisco Collaboration Problem Report Tool (PRT) to collect and send phone logs, and to report problems to your administrator. If you see a message that the PRT upload has failed, the problem report is saved on the phone and you should alert your administrator.

### Procedure

---

- Step 1** Press **Applications** .
- Step 2** Select **Phone information > Report problem**.
- Step 3** Select **Settings > System information > Report problem**.
- Step 4** Enter the date and time that you experienced the problem in the Date of problem and Time of problem fields.
- Step 5** Select **Problem description**.

**Step 6** Select a description from the displayed list, then press **Submit**.

---

## Lost Phone Connectivity

Sometimes your phone loses its connection to the phone network. When this connection is lost, your phone displays a message.

If you are on an active call when the connection is lost, the call continues. But, you don't have access to all normal phone features because some functions require information from the call control system. For example, your softkeys might not work as you expect.

When the phone reconnects to the call control system, you'll be able to use your phone normally again.

For more information on phone registration, please visit [Manual phone registration](#).

## Cisco One-Year Limited Hardware Warranty Terms

Special terms apply to your hardware warranty and services that you can use during the warranty period.

Your formal Warranty Statement, including the warranties and license agreements applicable to Cisco software, is available at: [Product Warranties](#).





## CHAPTER 2





# Calls

---



- [Audio Path Selection, on page 47](#)
- [Make Calls, on page 48](#)
- [Make a Call With A Hotline Phone, on page 53](#)
- [Answer Calls, on page 53](#)
- [Mark Your Calls as Spam, on page 58](#)
- [Video Calls, on page 60](#)
- [Mute your call, on page 62](#)
- [Hold Calls, on page 62](#)
- [Forward Calls, on page 66](#)
- [Transfer a Call to Another Person, on page 66](#)
- [Conference Calls and Meetings, on page 67](#)
- [Intercom Calls, on page 69](#)
- [Supervise and Record Calls, on page 70](#)
- [Prioritized Calls, on page 71](#)
- [Multiple Lines, on page 73](#)
- [Mobile Devices and Your Desk Phone, on page 76](#)
- [Voicemail, on page 83](#)

## Audio Path Selection

When you make or receive a call, the audio path goes to the last device used by you, either the handset, the headset, or the speakerphone. The following list describes each scenario:

- Pick up the handset when you make or answer a call, and all of your calls are routed to your handset until you select **Headset**  or **Speakerphone** .
- Select **Headset**  when you make or answer a call, and all of your calls are routed to your headset until you pick up the handset or select **Speakerphone** .

If your administrator sets your headset as the audio path on your phone, then you can remove the headset and use your handset. This is ideal for anyone who prefers the convenience of a headset. But you must still select **Headset** the first time you handle a call.

- Select **Speakerphone**  when you make or answer a call, and all of your calls are routed to your speakerphone until you pick up the handset or select **Headset** .

**Related Topics**

[Buttons and Hardware](#), on page 22

# Make Calls

Your phone works just like a regular phone. But we make it easier for you to make calls.

## Make a Call

Use your phone just like any other phone to make a call.

**Procedure**

---

**Step 1** Enter a number and pick up the handset.

**Step 2** Enter a number and press **Call**.

---

## Make a Call with the Speakerphone

Use your speakerphone for hands-free calling. Keep in mind that your coworkers might be able to hear your call too.

**Procedure**

---

**Step 1** Enter a number using the keypad.

**Step 2** Press **Speakerphone** .

---

## Make a Call with a Standard Headset

Use your headset for hands-free calling that won't disturb your coworker and gives you some privacy.

**Procedure**

---

**Step 1** Plug in a headset.

**Step 2** Enter a number using the keypad.

**Step 3** Press **Headset** .

---

## Make a Call with a Phone or Video Address

Sometimes, instead of just having someone's phone number, you might also have a phone or video address that you can use to place the call instead.

This address might look like an email address, such as `username1@example.com`, or it might contain numbers like `username2@209.165.200.224`.

If you and the person you're calling have video phones, you'll be able to see each other.

### Procedure

---

- Step 1** Press **New call**.
- Step 2** Press **ABC** and you'll be able to enter text using the keypad.
- Step 3** Press a number on the keypad to see the available options, and then press the number again to move through the choices.
- For example, press the number **1** three times to enter the **@** symbol.
- Step 4** Press **Call**.
- 

## Redial a Number

You can call the most recently dialed phone number.

### Procedure

---

- Step 1** (Optional) Select a line.
- Step 2** Press **Redial**.
- 

## Speed Dial

You can assign buttons or codes to quickly dial the numbers of people you call often. Before you can use speed-dial features, configure a speed dial button in the Self Care portal or on your phone. Speed dial buttons configured from the phone do not appear in the Self Care Portal.

You can assign codes to quickly dial the numbers of people you call often. Before you can use speed-dial features on your phone, set up speed dial in the Self Care portal. Speed-dial codes allow you to phone number from a code (sometimes referred to as abbreviated dialing).

Depending on your setup, your phone can support these features:

- Speed-dial buttons—Dial a phone number from one or more line buttons set up for speed dialing.
- Speed-dial codes—Dial a phone number from a code (sometimes referred to as abbreviated dialing).

**Related Topics**

[Self Care Portal](#), on page 20

[Speed-Dial Numbers](#), on page 21

## Make a Call with a Speed-Dial Button

Each phone model has a specific number of lines available for phone features. Each feature requires one line to function so not all lines are available for speed-dial numbers. Some lines could be used for other features. If you add more speed-dial numbers than available lines, the remaining speed-dial numbers do not display on your phone.

For example, if you add 10 speed-dial numbers but your phone has 7 lines available then only 7 speed-dial numbers display on the phone.

To check which phone model you have, press **Applications**  and select **Phone information**. The **Model number** field shows your phone model.

**Before you begin**

Set up speed-dial codes in the Self Care portal.

**Procedure**

---

Press a speed-dial button .

---

**Related Topics**

[Self Care Portal](#), on page 20

## Make a Call With a Speed-Dial Code

**Before you begin**

Set up speed-dial codes in the Self Care portal.

**Procedure**

---

**Step 1** Enter the speed-dial code and press **Speed Dial**.

**Step 2** Enter the speed-dial code and press **Abbr dial**.

---

**Related Topics**

[Self Care Portal](#), on page 20

## Make a Call With a Fast-Dial Button

**Before you begin**

You need to set up the fast-dial codes in your personal directory.



### Procedure

---

- Step 1** Press **Fast Dial**.
  - Step 2** Sign in to Personal Directory.
  - Step 3** Select **Personal Fast Dials**.
  - Step 4** Select a fast-dial code and then press the **Dial** softkey.
- 

### Related Topics

[Assign a Fast-Dial Code to a Contact](#), on page 89

## Add a Speed Dial Button from Your Phone

You can configure a speed dial button from your phone in addition to the Self Care Portal. But speed dial buttons that are configured from the phone do not display in the Self Care Portal.

This feature is supported on the Cisco IP Phones 8800 Series and the following key expansion modules:

- Cisco IP Phone 8800 Key Expansion Module
- Cisco IP Phone 8851 and 8861 Key Expansion Module
- Cisco IP Phone 8865 Key Expansion Module

A Reset All clears any speed-dial buttons that are created from your phone.

### Procedure

---

- Step 1** Press and hold a line key for 2 seconds.
  - Step 2** In the Name field, enter the name of the speed-dial number.
  - Step 3** In the Number field, enter the phone number. Include all digits required to complete the call.
  - Step 4** Select **Apply** to save your speed-dial number.
- 

### Related Topics

[Self Care Portal](#), on page 20

## Modify a Speed Dial Button from Your Phone

You can use your phone to modify or edit a speed-dial button, if you cannot access the Self Care Portal. But it does not apply to speed-dial buttons created from the Self Care Portal, or from the Cisco Unified Communications Manager by your administrator.

### Procedure

---

- Step 1** Press and hold a line key for 2 seconds.
- Step 2** In the Name field, enter the new name of the speed-dial number, if required.

- Step 3** In the **Number** field, enter the new phone number, if required. Include all the digits required to complete the call.
- Step 4** Select **Apply** to save your speed-dial number.
- 

## Delete a Speed Dial Button from Your Phone

You can use your phone to delete a speed-dial button. This method only works if you added the speed-dial buttons from the phone. It does not apply to speed-dial buttons added from the Self Care Portal, or from the Cisco Unified Communications Manager by your administrator.

### Procedure

---

- Step 1** Press and hold a line key for 2 seconds.
- Step 2** Select **Delete**.
- Step 3** Select **Yes** to confirm your choice.
- 

## Dial an International Number

You can dial international calls when you prefix the phone number with a plus (+) sign.

### Procedure

---

- Step 1** Press and hold **star** (\*) for at least 1 second.  
The plus (+) sign is displayed as the first digit in the phone number.
- Step 2** Enter the phone number.
- Step 3** Press **Call** or wait 10 seconds after the last key press to automatically place the call.
- 

## Get Notified When a Contact is Available

If you call someone and their line is busy or they do not answer, you can be notified with a special ringtone and a message when they are available.

### Procedure

---

- Step 1** Press **Callback** while you are listening to the busy tone or ring sound.
- Step 2** Press **Exit** to exit the confirmation screen.
- Step 3** When you hear the ringtone that the person is available and see the message, press **Call** to place the call again.
-

## Calls That Require a Billing Code or Authorization Code

Your administrator may require that you enter a billing code or authorization code (or both codes) after you dial a phone number. The billing code, called a Client Matter Code, is used for accounting or billing purposes. The authorization code, called a Forced Authorization Code, controls access to certain phone numbers.

When a billing code is required, the phone displays `Enter Client Matter Code`, the dialed number changes to “\*\*\*\*\*”, and you hear a special tone.

When a billing code is required, the phone displays `Enter Client Matter Code`. Enter the billing code. The phone displays the billing code that you entered, and you hear a special tone.

When an authorization code is required, the phone displays `Enter Authorization Code`, the dialed number changes to “\*\*\*\*\*”, and you hear a special tone. For security reasons, the phone displays a “\*” instead of the number entered.

When both a billing code and an authorization code are required, you are prompted for the authorization code first. Then you are prompted for the billing code.

### Related Topics

[Speed-Dial Numbers](#), on page 21

## Secure Calls

Your administrator can take steps to protect your calls from tampering by people outside your company. When a lock icon is displayed on your phone during a call, your phone call is secure. Depending upon how your phone is configured, you may have to sign on before you make a call or before a security tone plays over your handset.

## Make a Call With A Hotline Phone

Some workplaces have a phone that is meant for emergency or hotline calls. These phones automatically call a designated number when you lift the receiver and are popular choices for elevators, hotel lobbies or security booths.

Most hotline phones don't allow you to dial a phone number. They're dedicated phones that ring to a single phone number. However, some hotline phones do allow you to place a call. If this feature is configured, then you have up to 15 seconds to place a call. Otherwise, the call automatically goes to the hotline number.

### Procedure

- 
- |               |  |
|---------------|--|
| <b>Step 1</b> | Lift the phone receiver and wait for the call to ring. |
| <b>Step 2</b> | (Optional) Dial a phone number.                        |
- 

## Answer Calls

Your Cisco phone works just like a regular phone. But we make it easier for you to answer calls.

## Answer a Call

### Procedure

---

When your phone rings, press the flashing line button to answer the call.

---

## Answer Call Waiting

When you are on an active call, you know that a call is waiting when you hear a single beep and see the line button flash.

### Procedure

---

**Step 1** Press the line button.

**Step 2** (Optional) If you have more than one call waiting, select an incoming call.

---

## Decline a Call

You can send a ringing call to your voicemail system (if configured). If not set up, the call is rejected and the caller hears a busy tone.

### Procedure

---

**Step 1** Decline a call by performing one of the following actions:

- Press **Decline**.
- If you have multiple incoming calls, highlight the incoming call and press **Decline**.

**Step 2** Press **Decline**.

---

## Ignore a Call

If you do not want to be disturbed, you can ignore an incoming call. The call goes to voicemail.

### Procedure

---

Ignore a call by performing one of the following actions:

- Select **Ignore**.

- Press **Volume** down once to silence the incoming (ringing) call, and then let the incoming call go to your voicemail or to a preset phone number.
- 

## Turn On Do Not Disturb

Use do not disturb (DND) to silence your phone and ignore incoming call notifications when you need to avoid distractions.

When you turn on DND, your incoming calls are forwarded to another number, such as your voicemail, if it is set up.

When DND is turned on, the header section of the phone screen changes color and **Do not disturb** is displayed on the phone screen.

When you turn on DND, it affects all lines on your phone. However, you will always receive intercom and emergency calls, even when DND is turned on.

If multilevel precedence and preemption (MLPP) is set up for your phone, priority calls will ring your phone with a special ringtone, even when DND is turned on.

### Procedure

---

- Step 1** Press **Do not disturb** to turn on DND.
  - Step 2** Press **Do not disturb** again to turn off DND.
  - Step 3** Press **Turn off DND** to turn off DND.
- 

## Answer a Coworker's Phone (Call Pickup)

If you share call handling tasks with your coworkers, you can answer a call that is ringing on a coworker's phone. First, your administrator has to assign you to at least one call pickup group.

## Answer a Call Within Your Group (Pickup)

You can answer a call that rings on another phone within your call pickup group. If multiple calls are available for pickup, you'll answer the call that has been ringing for the longest time.

### Procedure

---

- Step 1** (Optional) Press the line button.
  - Step 2** Press **PickUp** to transfer an incoming call within your pickup group to your phone.
  - Step 3** Press **Answer** to connect to the call when the call rings.
-

## Answer a Call from Another Group (Group Pickup)

Group pickup allows you to answer a call on a phone that is outside your call pickup group. You can use the group pickup number to pick up the call, or you can use the number of the phone line that is ringing.

### Procedure

---

**Step 1** (Optional) Press the line button.

**Step 2** Press **Group Pickup**.

**Step 3** Do one of the following actions:

- Enter the number of the phone line with the call that you want to pick up.

For example, if the call is ringing on line 12345, enter **12345**.

- Enter the group pickup number.
- Press **Speed dials** and select a speed dial number. Use the Navigation cluster to move up and down within the Speed dial window, and to select the speed dial number.

**Step 4** Press **Answer** to connect to the call when the call rings.

---

## Answer a Call From an Associated Group (Other Pickup)

### Procedure

---

**Step 1** (Optional) Press the line button.

**Step 2** Press **PickUp** to answer a call in your pickup group or in a group that is associated with your phone.

**Step 3** If the call rings, press **Answer** to connect to the call when the call rings.

---

## Answer a Call Within Your Hunt Group

Hunt groups allow organizations that receive many incoming calls to share the call load. Your administrator sets up a hunt group with a series of directory numbers. Phones ring based on the hunt sequence that your administrator specifies for a hunt group. If you are a member of a hunt group, you sign into a hunt group when you want to receive calls. You sign out of the group when you don't want calls to ring on your phone.

Depending on how hunt groups are configured, you may see the following information displayed on your Call Alert:

- The line that receives the call.
- The directory number for the incoming call.
- The hunt group name or pilot number.

**Before you begin**

You must sign into the hunt group to receive hunt group calls.

**Procedure**

---

When a hunt group call rings on your phone, answer the call.

---

**Sign In and Out of a Hunt Group**

Sign out of your hunt group to stop receiving calls from it. You continue receiving calls placed directly to you.

**Procedure**

- 
- Step 1** Press **Hunt Group** to sign in.  
**Step 2** Press **Hunt Group** again to sign out.
- 

**View the Call Queue in a Hunt Group**

You can use the queue statistics to check the status of the hunt group queue. The queue status display provides the following information:

- The phone number used by the hunt group
- Number of queued callers on each hunt group queue
- Longest waiting time

**Procedure**

- 
- Step 1** Press **Queue Status**.  
**Step 2** Press **Update** to refresh the statistics.  
**Step 3** Press **Exit**.
- 

**Answer Calls Automatically**

If your phone is set up to answer calls automatically, you don't do anything when your phone rings. After one ring, you're automatically connected to the call using the speakerphone.

If you prefer to use your headset to answer the call, set up your headset first.

If you automatically answer calls on your speakerphone and you change the call to the headset, your next incoming call automatically answers on the headset. If you automatically answer calls on your headset and

you change the call to the speakerphone, your next incoming call automatically rings on the speakerphone. Automatic answer ensures that the call is answered; it does not change the location that you used for the previous call.

#### Procedure

---

- Step 1** Connect your headset to your phone.
  - Step 2** Make sure that the **Headset** button  lights up.
  - Step 3** When your phone automatically answers the incoming call, talk to the caller using your headset.  
If you don't want to use your headset anymore, then pick up the handset and you will leave headset mode.
- 

## Trace a Suspicious Call

If you receive unwanted or harassing calls, use malicious call identification (MCID) to alert your administrator. Your phone sends a silent notification message to your administrator with information about the call.

#### Procedure

---

Press **Report caller**.

---

## Mark Your Calls as Spam

You can use the Mark spam feature to reduce the number of unwanted phone calls that you receive. With this feature, you designate a phone number as either a potentially fraudulent call or as a telemarketer call. If you mark a call as fraudulent, then it is declined and the number is blocked from calling you again. If you mark a call as a telemarketer, then it rings through to you. But calls from this number display the term Telemarketer in the Incoming Call Alert and display an icon next to them in Recents.

Your administrator can enable or disable this feature. When disabled, you don't see the softkey, the spam list is empty, and you can't view or add to it. If the feature was enabled and your administrator disables it, the phone deletes the spam list.

You can view and edit your Spam call list from the **Settings** menu. The Spam call list can have up to 150 calls.

## Mark an Unwanted Active Call

You can mark an active call as either fraudulent or as a telemarketer. This helps reduce the number of unwanted calls. The Spam call list can have up to 150 calls. You can add more than 150 calls, but they won't appear in your list.



### Procedure

---

- Step 1** Press **Mark spam** when you are on a call.
- Step 2** Choose a status for the phone number.
- Potential fraud: Incoming calls from this number are declined and blocked if they call again.
  - Telemarketer: Incoming calls from this number ring through to you. But these calls have the term Telemarketer in the Incoming Call Alert and have an icon next to them in Recents.
- Step 3** Press **Apply**.
- 

## Mark an Unwanted Video Call

You can mark an active video call as either fraudulent or as a telemarketer. This helps reduce the number of unwanted video calls.

### Procedure

---

- Step 1** Press **Call list** when you are on a video call.
- Step 2** Press **Mark spam**.
- Step 3** Choose a status for the phone number.
- Potential fraud: Incoming calls from this number are declined and blocked if they call again.
  - Telemarketer: Incoming calls from this number ring through to you. But these calls have the term Telemarketer in the Incoming Call Alert and have an icon next to them in Recents.
- Step 4** Press **Apply**.
- 

## Mark an Unwanted Recent Call

You can mark a recent call as either a fraudulent call or as a telemarketer call. Fraudulent calls are blocked the next time they call you. Telemarketer calls ring through to you. But these calls have the term Telemarketer in the Incoming Call Alert and have an icon next to them in Recents.

The Spam call list can have up to 150 calls. You can add more than 150 calls, but they won't appear in your list.

### Procedure

---

- Step 1** Press **Applications** .
- Step 2** Choose **Recents**.
- When the phone is idle, you can also press up on the Navigation cluster to view the Recent calls list.
- Step 3** Use the Navigation cluster and select a phone number from your list of recent calls.

- Step 4** Press **Mark spam**.
- Step 5** Choose a flag for the phone number.
- Potential fraud: Incoming calls from this number are blocked.
  - Telemarketer: Incoming calls from this number display the term Telemarketer in the Incoming Call Alert and have an icon next to them in Recents.
- Step 6** Press **Apply**.
- 

## Remove or Edit a Marked Call

You can edit a marked call if you want to change the status. You can also remove a call from your Spam calls list so it's not screened or blocked.

### Procedure

---

- Step 1** Press **Applications** .
- Step 2** Choose **Settings** > **Spam call list**.
- Step 3** Use the Navigation cluster to navigate and select the call.
- Step 4** Change the call status:
- Press **Unmark spam** to remove a call. At the warning window, press **Delete**.
  - Press **Edit** to change a flag. Press **Apply**.
- 

## Video Calls

Cisco IP Phones 8845, 8865, and 8865NR support video calls with a built-in video camera.

You can make an audio call into a video call by opening your camera shutter.

### Related Topics

[Video Settings](#), on page 101

## Make a Video Call



---

**Note** Video calling between Webex Calling MPP devices is restricted to internal calls within your own company. It includes calls to others within your own site and to other locations.

---

Cisco IP Phones 8845, 8865, and 8865NR support video calls as long as the person you're calling also has a video phone. The ring on the outside of the camera controls the shutter.

### Procedure

---

- Step 1** Turn the ring around the camera clockwise to open the shutter.
  - Step 2** (Optional) Press **Self-view** and move the camera up and down to improve the perspective.
  - Step 3** Make your call.
- 

## Stop Your Video

When you are on a video call, you can stop the camera from sending video. The ring on the outside of the camera controls the shutter. When you close the shutter, the person you're talking to won't see you anymore, but they'll still be able to hear you.

If you close the shutter, you will continue receiving video from the other party on the call.

If both people on a call close their camera shutters, the call becomes an audio call.

### Procedure

---

- Step 1** Turn the shutter ring counterclockwise to close the camera shutter and stop sharing your video.
  - Step 2** Turn the shutter ring clockwise to open the video camera shutter and share your video again.
- 

## Toggle Between Phone and Video Display

If you need to see your phone's desktop while you're on a video call, you can easily switch between the video and the desktop. When you hide the video, it blurs and moves to the background.

### Procedure

---

- Step 1** Press **Hide video** to hide the video.
  - Step 2** Press **Show video** to show the video.
- 

## Adjust the Picture-In-Picture Position

When you are on a video call, you can view your incoming and your outgoing video at the same time, which is known as Picture-in-Picture (PiP). Typically, the incoming video displays on the full screen and a small inset screen shows the video from your camera.

When PiP is on, you can move the inset picture to a different quadrant of the screen. You can also change the view so that your camera video displays on the full screen and the inset displays the incoming video.

### Procedure

---

- Step 1** Press **PiP** to turn on PiP.
- Step 2** Press **PiP** again to move the PiP window counter-clockwise around your phone screen.  
When the window returns to the default lower right position, PiP automatically turns off.
- Step 3** (Optional) Press **Swap** to toggle between the full-screen view and the PiP view.
- 

## Video Calls and Security

Your administrator can take steps to protect your video calls from tampering by people outside your company. If you see the **Secure** icon displayed during a video call, your administrator has taken steps to ensure your privacy.

### Related Topics

[Secure Calls](#), on page 53

## Mute your call



While you are on a call, you can mute the audio, so that you can hear the other person, but they cannot hear you.

If you have a video phone, when you mute your audio, your camera continues to transmit video.

When you have a call muted, the LED bar lights red.

### Procedure

---

- Step 1** Press **Mute** .
- Step 2** Press **Mute**  on the phone or **Mute**  on an expansion microphone.  
When you press **Mute** on an expansion microphone, the phone and all microphones are muted.
- Step 3** Press **Mute** again to turn mute off.
- 

## Hold Calls

### Put a Call on Hold

You can put an active call on hold and then resume the call when you're ready.

You can put an active call on hold and then resume the call when you're ready. When you place a video call on hold, video transmission is blocked until you resume the call.

#### Procedure

---

- Step 1** Press **Hold** .
  - Step 2** Press **Hold**.
  - Step 3** To resume a call from hold, press **Hold** again.
  - Step 4** To resume a call from hold, press **Resume**.
- 

## Answer a Call Left on Hold for Too Long

When you've left a call on hold too long, you'll be notified with these cues:

- Single ring, repeating at intervals
- Flashing amber line button
- Flashing message indicator on the handset
- Flashing LED bar
- Visual notification on the phone screen

#### Procedure

---

Press the flashing amber line button or **Answer** to resume the held call.

---

## Swap Between Active and Held Calls

You can easily switch between active and held calls.

#### Procedure

---

Press **Swap** to switch to the held call.

---

## Call Park

You can use your phone to park a call. You can then retrieve the call either from your phone or another phone, such as a phone at a coworker's desk or in a conference room.

There are two ways you can park a call: call park and directed call park. You'll only have one type of call park available on your phone.

You can use your phone to park a call.

A parked call is monitored by your network so you won't forget about it. If the call remains parked for too long, you hear an alert. You can then answer, decline to answer, or ignore the call on your original phone. You can also continue retrieving it from another phone.

If you don't answer the call within a certain length of time, it's routed to voicemail or another destination, as set by your administrator.

It is configurable that a parked call occupies one line or not.

## Place a Call on Hold with Call Park

You can park an active call that you answered on your phone and then use another phone in the call control system to retrieve the call.

You can park only one call at the call park number.

Your administrator can set up Call Park in one of two ways:

- The parked call displays on your phone screen and you can press **Resume** to pick it up. The line number for the parked call is displayed on your line.
- A line number for the parked call displays in a pop-up window. Your line becomes idle. In this case, you dial the line to pick up the parked call.

### Before you begin

Your call must be active.

### Procedure

---

**Step 1** Press **Park**, and then hang up.

**Step 2** (Optional) Communicate the parked number to the person who needs to answer the call.

---

## Retrieve a Call on Hold with Call Park

You can set up call park in two different ways:

- The parked call displays on the phone where the user can pick it up.
- The user must dial the displayed number to pick up the call.

You set the field Dedicate one line for Call Park in Cisco Unified Communications Manager to enable or disable the feature. By default, the feature is enabled.

### Before you begin

You need the number that was used to park the call.

### Procedure

---

Enter the number where the call is parked and retrieve the call.

---

## Place a Call on Hold with Assisted Directed Call Park

You can park and retrieve an active call using a dedicated call park number. Using assisted directed call park, you use a button to park an active call. Your administrator sets up the button as a speed-dial line. With this type of directed call, you can use line status indicators to monitor the status of the line (in-use or idle).

### Procedure

---

Press **BLF Directed Call Park** on a line that displays an idle line status indicator for an assisted directed call park.

---

## Retrieve a Call on Hold with Assisted Directed Call Park

### Procedure

---

Press **BLF Directed Call Park**.

---

## Place a Call on Hold with Manual Directed Call Park

You can park and retrieve an active call using a dedicated call park number. Using manual directed call park, you transfer an active call to a directed call park number, which your administrator sets up.

### Procedure

---

- Step 1** Press **Transfer** .
  - Step 2** Required: Enter the directed call park number.
  - Step 3** Required: Press **Transfer** again to park the call.
- 

## Retrieve a Call on Hold with Manual Directed Call Park

You can pick up a call that was parked to a dedicated call park number.

### Before you begin

You need the directed call park number and the park retrieval prefix.

### Procedure

---

- Step 1** Dial the park retrieval prefix.
- Step 2** Dial the directed call park number.
- 

## Forward Calls

You can forward calls from any line on your phone to another number. Call forward is phone-line specific. If a call reaches you on a line where call forwarding is not enabled, the call rings as usual.

You can forward calls from your phone to another number.

There are two ways of forwarding your calls:

- Forward all calls
- Forward calls in special situations, such as when the phone is busy or there is no answer.

When a line is forwarded, you see the Forward all  icon with the line.

When a phone is forwarded, you see the Forward all  icon on the screen.

### Procedure

---

- Step 1** When the line to be forwarded is inactive, press **Fwd All**.
- Step 2** When the phone is inactive, press **Forward All**.
- Step 3** Enter the call forward target number exactly as you would dial it from your phone, or select an entry from your list of recent calls.
- 

### Related Topics

[Self Care Portal](#), on page 20

## Transfer a Call to Another Person

When you transfer a call, you can stay on the original call until the other person answers. This way, you can talk privately with the other person before you remove yourself from the call. If you don't want to talk, transfer the call before the other person answers.

You can also swap between both callers to consult with them individually before you remove yourself from the call.

### Procedure

---

- Step 1** From a call that is not on hold, press **Transfer** .



- Step 2** From a call that is not on hold, press **Transfer**.
- Step 3** Enter the other person's phone number.
- Step 4** (Optional) Press **Speed dials** and select a Speed dial number.  
Use the Navigation cluster to move within the Speed dial window, and to select your Speed dial number.
- Step 5** (Optional) Wait until you hear the line ring or until the other person answers the call.
- Step 6** Press **Transfer** again.
- 

## Conference Calls and Meetings

You can talk with several people in a single call. You can dial another person and add them to the call. If you have multiple phone lines, you can join two calls across two lines.

You can talk with several people in a single call. You can dial another person and add them to the call.

When you add more than one person to a conference call, wait a few seconds between adding participants.

As the conference host, you can remove individual participants from the conference. The conference ends when all participants hang up.

## Add Another Person to a Call

When you add more than one person to a call, wait a few seconds between adding participants.

### Procedure

---

- Step 1** From an active call, press **Conference** .
- Step 2** Add the other person to the call by doing one of the following:
- Press **Active** calls and select a held call.
  - Enter the phone number and press **Call**.
  - Press **Speed dials** and select a Speed dial number. Use the Navigation cluster to move within the Speed dial window, and to select your number.
- Step 3** Press **Conference**.
- 

## Swap Between Calls Before You Complete a Conference

You can talk to a person before you add them to a conference. You can also swap between the conference call and the call with the other person.

### Procedure

---

- Step 1** Call a new conference participant, but do not add the participant to the conference.  
Wait until the call is connected.
- Step 2** Press **Swap** to toggle between the participant and the conference.
- 

## View and Remove Conference Participants

If you create a conference, you can view the details of the last 16 participants who join the conference. You can also remove participants.

### Procedure

---

- Step 1** While you are in a conference, press **Show Details** to view a list of participants.
- Step 2** (Optional) Highlight a participant and press **End call** to stop the call and drop the participant from the conference.
- Step 3** (Optional) Highlight a participant and press **Remove** to drop the participant from the conference.
- 

## Scheduled Conference Calls (Meet Me)

You can host or join a conference call at a scheduled time.

The conference call does not start until the host dials in, and it ends when all participants hang up. The conference does not automatically end when the host hangs up.

### Host a Meet-Me Conference

#### Before you begin

Get a meet-me phone number from your administrator, and distribute the number to the conference participants.

### Procedure

---

- Step 1** Lift the handset to get a dial tone and press **Meet Me**.
- Step 2** Press **Meet Me**.
- Step 3** Dial the meet-me phone number.
-

## Join a Meet-Me Conference

You cannot join a meet-me conference until the conference hosts dials in. If you hear a busy tone, the host has not dialed into the conference. Hang up and try your call again.

You cannot join a meet-me conference until the conference hosts dials in. If you hear a busy tone, the host has not dialed into the conference. End the call and try your call again.

### Procedure

---

Dial the meet-me phone number that the conference host provides.

---

## Intercom Calls

You can use an intercom line to place and receive one-way calls.

When you place an intercom call, the recipient's phone answers the call automatically with mute activated (whisper mode). Your message is broadcast through the recipient's speakerphone, headset, or handset, if one of these devices is active.

But sometimes intercom calls are rejected when you are on a call. This depends upon how your company's phone network is set up. Contact your administrator for additional information.

After receiving the intercom call, the recipient can start two-way audio (connected mode) to allow for further conversation.

## Make an Intercom Call

When you place an intercom call, your phone enters whisper mode until the recipient accepts the intercom call. In whisper mode, the other person can hear you, but you can't hear them. If you are on an active call, that call is placed on hold.

### Procedure

---

- Step 1** Press **Intercom**.
  - Step 2** (Optional) Enter the intercom code.
  - Step 3** Listen for the intercom alert tone, and then begin speaking.
  - Step 4** Press **Intercom** to end the call.
- 

## Answer an Intercom Call

You can answer an intercom call to talk to the other person.

**Before you begin**

You receive a message on your phone screen, and an audible alert. Your phone answers the intercom call in whisper mode.

**Procedure**

- 
- Step 1** Press **Intercom** to switch to connected mode. In connected mode, you can speak to the intercom caller.
- Step 2** Press **Intercom** to end the call.
- 

## Supervise and Record Calls

You can supervise and record a call. But you must have a minimum of three people on a line: the person calling, the chaperone, and the person called.

The chaperone answers a call, creates a conference call, and monitors and records the conversation.

The chaperone performs the following tasks:

- Records the call.
- Conferences in the first participant only. Other participants add people as needed.
- Ends the call.

The conference ends when the chaperone hangs up the call.

## Set Up a Supervised Call

**Procedure**

- 
- Step 1** Answer an incoming call.
- Record** is displayed if the system determines that the call must be chaperoned and recorded.
- Step 2** Press **Conference**  to create a conference call.
- Step 3** Press **Conf** to create a conference call.
- Step 4** Enter the phone number for the supervisor and press **Call**.
- Step 5** Press **Conference** when the supervisor answers.
- Step 6** Press **Conf** when the supervisor answers.
- Step 7** Press **End Call** to end the call.
-

## Record a Call

You can record a call. You might hear a notification tone as you record the call.

### Procedure

---

Press **Record** to start or stop recording.

---

## Prioritized Calls

In your job, you might need to handle urgent or critical situations with your phone. You can identify calls as very important; these have a higher priority than normal calls. The priorities range from level 1 (low) to level 5 (high). This system of priorities is called multilevel precedence and preemption (MLPP).

Your administrator sets up the priorities that you can use and determines whether you need special sign-in information.

When a high-priority call rings on your phone, you see the priority level on the phone screen and the call appears at the top of the call list. If you are on a call when a high-priority call comes to your phone, the high-priority call preempts the current call and you hear a special preemption ringtone. You should hang up from your current call to answer the high-priority call.





If you have turned on do not disturb (DND), a priority call will still ring your phone with a special ringtone.

When you are on a high-priority call, the priority of the call does not change when you:

- Put the call on hold
- Transfer the call
- Add the call to a three-way conference
- Use call pickup to answer the call.

The following table describes the Multilevel Precedence and Preemption Priority icons and the corresponding level.

**Table 24: Multilevel Precedence and Preemption Priority Levels**

MLPP icon	Priority Level
	Level 1—Priority call
	Level 2—Medium priority (Immediate) call
	Level 3—High priority (Flash) call
	Level 4—Flash Override
	Level 5—Executive Override

## Make a Priority Call

To make a priority call, you might need to sign in with your special credentials. You have three chances to enter these credentials, and you're notified if you've entered them incorrectly.

### Procedure

---

- Step 1** Pick up the handset.
  - Step 2** Press **PrecLevel**.
  - Step 3** Select a priority level for the call.
  - Step 4** (Optional) Enter your credentials on the authorization screen.
  - Step 5** Enter the destination number.  
You see the precedence level icon on the phone screen and you hear the precedence ringback tone.
- 

## Answer a Priority Call

If you hear a special ring that's faster than usual, you are receiving a priority call.

### Procedure

---

- Step 1** Press the flashing amber session button when you hear the special ringtone for a precedence call.
  - Step 2** Press **Answer** when you hear the special ringtone for a precedence call.
- 

## Answer a Priority Call While on Another Call

If you hear a continuous tone that interrupts your call, you or your coworker are receiving a priority call. Hang up immediately and let the higher priority call go to the intended person.

### Procedure

---

- Step 1** Press **Release**  or hang up the handset.  
Your call ends, and the higher priority call rings on the appropriate phone.
  - Step 2** Press **End Call**.  
Your call ends, and the higher priority call rings on the appropriate phone.
-

# Multiple Lines

If you share phone numbers with other people, you could have multiple lines on your phone. When you have multiple lines, you have more calling features available to you.

## Answer the Oldest Call First

You can answer the oldest call available on all your phone lines, including Hold Reversion and Park Reversion calls that are in an alerting state. Incoming calls always have priority over Held or Park Reversion calls.

When working with multiple lines, you typically press the line button for the incoming call you want to answer. If you just want to answer the oldest call regardless of line, press **Answer**.

## View All Calls on Your Phone

You can view a list of all your active calls—from all your phone lines—sorted in chronological order, oldest to newest.

The list of all calls is useful if you have multiple lines or if you share lines with other users. The list displays all your calls together.

You can also display your active calls on your primary line, which is useful if you want all your calls that are displayed on a single screen.

If you have an active hunt group call, then the All calls list includes the term **Hunt group:** followed by the hunt group name or number, or both. This improvement helps you identify hunt group calls.

If your administrator configures the hunt group name, both the hunt group name and number display in the All calls list. Otherwise, only the hunt group number displays.

### Procedure

---

Press **All Calls** or the session button for your primary line.

---

## View Important Calls

You can view a list of all Alert Calls in chronological order (oldest to most recent). An Alert Call is a phone number that you consider important. You want to be alerted when you receive a call from or make a call to this number.

### Procedure

---

Press **Alert call**.

---

## Display Call Notifications on Select Lines with Line Filters

You can configure your phone so you are alerted when somebody calls a high priority phone number or line. For example, a senior executive's phone line or a customer help line. This tool is useful if you work with multiple phone lines and a high number of calls.

Depending upon how your administrator has configured your phone, you may be able to use a line filter during specific times of the day also.

### Create a Line Filter

#### Procedure

---

**Step 1** Press **Applications** .

**Step 2** Select **Settings** > **Call notifications** > **Add new filter**.

The maximum number of custom filters is 20. If you have already created the maximum number of custom filters, delete a filter before continuing with this procedure.

**Step 3** Press **Select** to make the text editable.

**Step 4** Accept the default name for the new filter, or enter a new one.

**Step 5** Select the lines to add to the new filter.

All available lines are displayed in the list. If you require a line that is not in the list, contact your administrator.

**Step 6** Click **Apply**.

**Step 7** To view the filter, press **Back**.

---

### Use a Line Filter

#### Procedure

---

**Step 1** Press **Applications** .

**Step 2** Select **Settings** > **Call notifications**.

**Step 3** Highlight the filter to apply and press **Select**.

---

### Change a Line Filter

You can change the line filters that you control. Your administrator controls the All Calls filter and the Daily schedule filter.



### Procedure

---

- Step 1** Press **Applications** .
- Step 2** Select **Settings** > **Call notification**.
- Step 3** Highlight a filter and Press **Edit** to change an existing filter.
- 

## Shared Lines

You can share a single phone number with one or more of your coworkers. For example, as an administrative assistant, you may be responsible for screening calls for the person you support.

When you share a phone number, you can use that phone line just like any other line. Be aware of these special characteristics about shared lines:

- The shared phone number appears on all phones that share the number.
- If your coworker answers the call, the shared line button and the session button are solid red on your phone.
- If you put a call on hold, your line button is solid green and the session button pulses green. But your coworker's line button is solid red and the session button pulses red.

## Add Yourself to a Call on a Shared Line

You or your coworker can join a call on the shared line. Your administrator needs to enable the feature on your phone.

If you try to add yourself to a call on a shared line and see a message that you cannot be added, try again.

If a user with whom you share a line has privacy turned on, you can't see their line settings and you can't add yourself to their call.

### Procedure

---

- Step 1** Press the line button for the shared line or select the line and press **Barge**.  
You need to press **Calls** to add yourself to a call on a shared line.
- Step 2** (Optional) If you see a confirmation message, press **Yes** to add yourself to the call.
- 

## Get Notified Before You Join a Call on a Shared Line

You can set up your phone to alert you when you barge in to a call. By default, the alert prompt is turned Off.

### Procedure

---

- Step 1** Press **Applications** .
  - Step 2** Select **Settings** > **Barge Alert**.
  - Step 3** Click **On** to enable the alert.
- 

## Enable Privacy on a Shared Line

Privacy prevents others who share your line from seeing information about your calls.

Privacy applies to all shared lines on your phone. If you have multiple shared lines and privacy is enabled, others cannot view any of your shared lines.

If the phone that shares your line has privacy enabled, you can make and receive calls using the shared line as usual.

Visual confirmation is displayed on your phone screen for as long as the feature is enabled.

### Procedure

---

- Step 1** Press **Privacy** to enable the feature.
  - Step 2** Press **Privacy** again to turn off the feature.
- 

## Mobile Devices and Your Desk Phone

If you have a mobile device (phone or a tablet), you can connect the mobile device to your desk phone. This connection allows you to make and answer phone calls on either the mobile device or the desk phone.

Cisco IP Phone 8851 and 8861 support this feature.

Do not pair two or more Cisco IP Phone 8800 Series desk phones.



---

**Note** When your mobile device is connected to the desk phone, the mobile device can't access or use the desk phone contacts. You can't move or copy the desk phone contacts to your mobile device.

---

## Phone Calls with Intelligent Proximity

When you use Bluetooth, you can pair your mobile device (phone or tablet) to your desk phone. After you pair and connect the mobile device, your phone displays an additional phone line, which is your mobile line (your mobile phone number). You can place and receive calls on this mobile line from your desk phone. This ability to use the mobile line on your desk phone is called Intelligent Proximity.

## Pair a Mobile Device with Your Desk Phone

After you pair your mobile device to your desk phone, the phone connects to the mobile device when the device is in range. It disconnects from the mobile device when the device is out of range.

If you have both a Bluetooth headset and a mobile device connected, you cannot use the Bluetooth headset to answer the audio from the mobile device.

After the mobile device and phone are connected, you can save your mobile contacts and call history on your desk phone.

### Before you begin

Make sure that your mobile device has Bluetooth turned on and that it is discoverable. Check the documentation included with your mobile device if you need help.

### Procedure

---

- Step 1** On your desk phone, press **Applications** .
- Step 2** Select **Bluetooth** > **Add Bluetooth device**.
- Step 3** Select the mobile device from the available devices list to pair.
- Step 4** Verify the passkey on the mobile device.
- Step 5** Verify the passkey on the desk phone.
- Step 6** (Optional) Choose to make your mobile device contacts and call history available on your desk phone.

### Related Topics

---

[Bluetooth and Your Phone](#), on page 31

[The Cisco IP Phone 8800 Series](#), on page 1

## Switch Connected Mobile Devices

If you have more than one paired mobile device in range of your Cisco IP Phone, you can choose which mobile device to connect.

### Procedure

---

- Step 1** Press **Applications** .
- Step 2** Select **Bluetooth**.
- Step 3** Select a mobile device from the available devices list.

## Delete a Mobile Device

You can delete a mobile device, so that it does not automatically connect using Bluetooth.

### Procedure

---

- Step 1** Press **Applications** .
- Step 2** Select **Bluetooth**.
- Step 3** Select the mobile device in the available devices list.
- Step 4** Select **Delete**.
- 

## View Your Paired Bluetooth Devices

A paired mobile device displays in the list of paired devices. You'll see this device listed until you unpair it from the desk phone.

### Procedure

---

- Step 1** Press **Applications** .
- Step 2** Select **Bluetooth**.
- 

## Intelligent Proximity for Mobile Phones

You can share your mobile contacts and call history with the desk phone, and move calls between your mobile phone and desk phone. You can also view signal strength and battery level of the mobile device on the desk phone.

### Handle an Incoming Mobile Call

#### Before you begin

Your mobile phone is paired to your desk phone.

#### Procedure

---

When a call rings on your mobile phone, do one of these actions on your desk phone:

- Press **Answer** to answer the call.
  - Press **Decline** to decline the call and send it to your voicemail.
  - Press **Ignore** to silence the ringer and decline the call.
- 

### Make a Mobile Call

#### Before you begin

Your mobile phone is paired to your desk phone.

---

**Procedure**

---

- Step 1** Select a mobile line on your desk phone.
- Step 2** Enter a phone number.
- Step 3** Press **Call**.
- 

**Move a Call Between the Desk Phone and a Mobile Device**

You can use your desk phone to move an active call to or from your mobile device.

**Before you begin**

Your mobile phone is paired to your desk phone.

**Procedure**

---

Press **Move audio** to move a call from your desk phone to your mobile device or in the opposite direction.

---

**Adjust the Mobile Device Volume**

Volume controls on your phone and mobile device are synchronized. Synchronization only occurs when there is an active call.

**Before you begin**

Your mobile phone is paired to your desk phone.

**Procedure**

---

Perform one of these options:

- Press **Volume**  on your desk phone. Press the + to increase the volume or - to decrease the volume.
  - Press the **Volume** button on your mobile device.
- 

**View Your Mobile Contacts on Your Desk Phone**

Use your desk phone to view the contacts list on your mobile phone. This is a convenient way to view a contact without accessing your mobile phone.

**Before you begin**

Before you can use your mobile device with your desk phone, use Bluetooth to pair the two phones. Select the option to share the mobile contacts.

### Procedure

---

- Step 1** Press **Contacts** .
- Step 2** Select your mobile phone from the list.
- 

### Save Contacts from Your Mobile Device on Your Desk Phone

You can save the contact list from your mobile device to your desk phone. This mobile contact list remains on your desk phone, even if you disconnect or unpair your mobile device.

#### Before you begin

Your mobile phone is paired to your desk phone.

### Procedure

---

- Step 1** Press **Contacts** .
- Step 2** Select your mobile phone.
- 

### Delete Contacts in Your Mobile Device Contact List

You can remove your mobile contacts list from your desk phone. The contacts list on your mobile phone remains intact.

#### Before you begin

Your mobile phone is paired to your desk phone.

### Procedure

---

- Step 1** Press **Contacts** .
- Step 2** Select your mobile phone from the directory list.
- Step 3** Check **Delete**.
- 

### View Your Mobile Call History on Your Desk Phone

You can view on your desk phone the recent calls placed or received from your mobile phone.

#### Before you begin

Before you can see the mobile call history on your desk phone, use Bluetooth to pair the mobile phone with your desk phone. Select the option to share your mobile call history with your desk phone.

### Procedure

---

On the desk phone, press **New Call**.

---

## Intelligent Proximity for Tablets

If you have a tablet, you can use Bluetooth to pair the tablet to your desk phone. After pairing, audio from a phone app on the tablet can be played on the desk phone. You can't use as many calling features on your tablet as you can with a mobile phone.

The desk phone supports connections from Android and iOS tablets.

### Move the Audio from Your Tablet to Your Desk Phone

#### Before you begin

Your tablet is paired to your desk phone and you receive a call on the tablet.

#### Procedure

---

- Step 1** On the tablet, set the audio path to use Bluetooth.
- Step 2** Use the headset, handset, or speakerphone to listen to the audio on the phone.
- 

### Move the Audio from Your Desk Phone to Your Tablet

#### Before you begin

Your tablet is paired to your desk phone and you are on a call on the tablet with the audio on the desk phone.

#### Procedure

---

Do one of the following actions:

- Hang up the handset.
  - Press **Release**.
  - Answer another call on the desk phone.
- 

## Phone Calls with Mobile Connect

You can use your mobile phone to handle calls that are associated with your desk phone number. This service is called Mobile Connect.

You associate your mobile phone with your desk phone in the Self Care portal, as an additional phone. You can control which calls are sent to your mobile phone.

When you enable additional phones:

- Your desk phone and your additional phones receive calls simultaneously.
- When you answer the call on your desk phone, the additional phones stop ringing, disconnect, and display a missed call message.
- When you answer the call on one additional phone, the other additional phones and desk phone stop ringing and disconnect. A missed call message shows on the other additional phones.
- You can answer the call on an additional phone and switch the call to a desk phone that shares the line. If you do so, the desk phones that share the same line display a `Remote In Use` message.

#### Related Topics

[Self Care Portal](#), on page 20

## Enable Mobile Connect

### Procedure

---

- Step 1** Press **Mobility** to display the current remote destination status (Enabled or Disabled).
- Step 2** Press **Select** to change the status.
- 

## Move a Call from Your Desk Phone to Your Mobile Phone

You can move a call from your desk phone to your mobile phone. The call is still connected to the line on your desk phone, so you cannot use that line for other calls. The line remains in use until the call ends.

### Before you begin

You need to enable Mobile Connect on your desk phone.

### Procedure

---

- Step 1** Press **Mobility**.
- Step 2** Press **Select** to send a call to your mobile phone.
- Step 3** Answer the active call on your mobile phone.
- 

## Move a Call from Your Mobile Phone to Your Desk Phone

You can move a call from your mobile phone to your desk phone. The call is still connected to your mobile phone.

### Before you begin

You need to enable Mobile Connect on your desk phone.



### Procedure

---

- Step 1** Hang up the call on your mobile phone to disconnect the mobile phone, but not the call.
  - Step 2** Press the line on your desk phone within 5 to 10 seconds to resume the call on your desk phone.
  - Step 3** Press **Answer** on your conference phone within 5 to 10 seconds to resume the call on your desk phone.
- 

## Transfer a Call from Your Mobile Phone to Your Desk Phone

You can transfer a call from your mobile phone to your desk phone.

### Before you begin

You need to enable Mobile Connect on your desk phone.

Get the access code from your administrator.

### Procedure

---

- Step 1** On the mobile phone, enter the access code for the hand-off feature.
  - Step 2** Hang up the call on your mobile phone to disconnect the mobile phone, but not the call.
  - Step 3** Press **Answer** on your desk phone within 10 seconds and start talking on the desk phone.
- 

## Voicemail

You can access your voice messages directly from your phone. Your administrator must set up your voicemail account and set up your phone before you can access the voicemail system.

The **Messages** button on your phone acts as a speed dial into the voicemail system.

The **Messages** softkey on your phone acts as a speed dial into the voicemail system.



---

**Note** If the conference phone is a shared phone used in a conference room, the **Messages** softkey may not display.

---

When you aren't at your desk, you can call your voicemail system to access your voicemail. Your administrator can give you the external phone number of the voicemail system.



---

**Note** This document has limited voicemail information because voicemail is not part of your phone. It is a separate component with a server and firmware that are purchased by your company. For information on setting up and using your voicemail, see the *User Guide for the Cisco Unity Connection Phone Interface* at <https://www.cisco.com/c/en/us/support/unified-communications/unity-connection/products-user-guide-list.html>.

---

## Voicemail Message Indication

To find out if you have new voicemail messages, look for one of these signs:

- The light strip on your handset is solid red.
- The number of missed calls and voicemail messages is displayed on your screen. If you have more than 99 new messages, a plus (+) sign is displayed.

You will also hear a stutter tone played from your handset, headset, or speakerphone when you use a phone line. This stutter tone is line-specific. You only hear it when you use a line that has voice messages.

### Related Topics

[Self Care Portal](#), on page 20

## Access Your Voicemail Messages

You can check your current voicemail messages or listen to your old messages again.

### Before you begin

Each voicemail system is different so check with your administrator or IT department to find out which system your company uses. This section is for Cisco Unity Connection because most Cisco customers use that product for their voicemail system. But your company may use a different product.

### Procedure

---

- Step 1** If you have more than line, press the appropriate line key.
- Step 2** Press **Messages** .
- Step 3** Press **Messages**.
- Step 4** Follow the voice prompts.
- 

## Visual Voicemail

Visual Voicemail is an alternative to audio voicemail that might be available to you, depending on your voicemail system. You use the screen on your phone to work with your messages, rather than respond to audio prompts. You can view a list of your messages and play your messages. You can also compose, reply to, forward, and delete messages.

Depending upon your voicemail system, you may be able to access your audio voicemail by selecting Audio inbox. Use this feature if you occasionally work with audio prompts, but you have the visual prompts set up as your default.

For more information, see *Quick Start Guide for Visual Voicemail for Unity Connection* at <http://www.cisco.com/c/en/us/support/unified-communications/unity-connection/products-user-guide-list.html>.

## Access Audio Voicemail

Depending upon how your administrator has set up your phone, you can retrieve your voicemail without viewing a list of messages. This option is useful if you prefer a list of voicemail messages, but you occasionally access your messages without the visual prompts.

### Procedure

---

- Step 1** In the screen, press the **Audio** softkey.
- Step 2** When prompted, enter your voicemail credentials.
- 

## Transfer a Call to Voicemail

You can transfer a call directly to your manager's or to a coworker's voicemail. This is a convenient way for a caller to leave a message but not disturb anyone in the office.



### Before you begin

Your administrator must set up your phone system so that the \* prefix before an extension means forward a call directly to voicemail.

Know your coworker's extension.

### Procedure

---

- Step 1** Press **Transfer** 
- Step 2** Enter \* followed by the person's extension.
- Step 3** Press **Transfer** 
-





## CHAPTER 3

# Contacts

---

- [Corporate Directory](#), on page 87
- [Personal Directory](#), on page 87
- [Cisco Web Dialer](#), on page 91

## Corporate Directory

You can look up a coworker's number from your phone, which makes it easier to give them a call. Your administrator sets up and maintains the directory.

### Dial a Contact in the Corporate Directory

#### Procedure

---

- Step 1** Press **Contacts** .
  - Step 2** Press **Contacts**.
  - Step 3** Select **Corporate Directory**.
  - Step 4** Select a search criteria.
  - Step 5** Enter your search criteria and press **Submit**.
  - Step 6** Select the contact and press **Dial**.
- 

## Personal Directory

Use the personal directory to store the contact information for friends, family, or coworkers. You can add your own contacts to the personal directory. You can add special speed-dial codes for people who you often call.

You can set up your personal directory from your phone or from the Self Care portal. Use your phone to assign speed-dial codes to the directory entries.

**Related Topics**

[Self Care Portal](#), on page 20

## Sign In and Out of a Personal Directory

**Before you begin**

Before you can sign in to your personal directory, you need your user ID and PIN. Contact your administrator if you don't know this information.

**Procedure**

---

- Step 1** Press **Contacts** .
  - Step 2** Press **Contacts**.
  - Step 3** Select **Personal directory**.
  - Step 4** Enter your user ID and PIN, and press **Submit**.
  - Step 5** To sign out, select **Log out**, press **Select**, and then press **OK**.
- 

## Add a New Contact to Your Personal Directory

**Procedure**

---

- Step 1** Press **Contacts** .
  - Step 2** Press **Contacts**.
  - Step 3** Sign in to your personal directory.
  - Step 4** Select **Personal Address Book** and press **Submit**.
  - Step 5** Press **New**.
  - Step 6** Enter first name, last name, and optionally a nickname.
  - Step 7** Press **Phones**, enter the phone number along with any required access codes, and then press **Submit**.
- 

## Search for a Contact in Your Personal Directory

**Procedure**

---

- Step 1** Press **Contacts** .
- Step 2** Press **Contacts**.
- Step 3** Sign in to your personal directory.

- Step 4** Select **Personal Address Book**.
  - Step 5** Select a search criteria.
  - Step 6** Enter your search criteria and press **Submit**.
- 

## Call a Contact in Your Personal Directory

### Procedure

---

- Step 1** Press **Contacts** .
  - Step 2** Press **Contacts**.
  - Step 3** Sign in to your personal directory.
  - Step 4** Select your **Personal directory** and search for an entry.
  - Step 5** Select the personal address book entry that you want to dial.
  - Step 6** Select the required fast-dial code and press **Call**.
- 

## Assign a Fast-Dial Code to a Contact

A fast-dial code makes it easier to call a contact.

### Procedure

---

- Step 1** Press **Contacts** .
  - Step 2** Press **Contacts**.
  - Step 3** Sign in to your personal directory.
  - Step 4** Select **Personal Address Book**.
  - Step 5** Select a search criteria.
  - Step 6** Enter the search criteria information and press **Submit**.
  - Step 7** Select the contact.
  - Step 8** Press **FastDial**.
  - Step 9** Select a number and press **Select**.
  - Step 10** Scroll to an unassigned fast-dial index and press **Submit**.
- 

### Related Topics

[Make a Call With a Fast-Dial Button](#), on page 50

## Call a Contact with a Fast-Dial Code

### Procedure

---

- Step 1** Press **Contacts** .
  - Step 2** Press **Contacts**.
  - Step 3** Sign in to your personal directory.
  - Step 4** Select **Personal Fast Dials** and scroll to a fast-dial code.
  - Step 5** Select the required fast-dial code and press **Call**.
- 

## Edit a Contact in Your Personal Directory

### Procedure

---

- Step 1** Press **Contacts** .
  - Step 2** Press **Contacts**.
  - Step 3** Sign in to your Personal directory.
  - Step 4** Select **Personal address book** and search for an entry.
  - Step 5** Press **Select**, then **Edit**.
  - Step 6** Modify the entry information.
  - Step 7** Press **Phones** to modify a phone number.
  - Step 8** Press **Update**.
- 

## Remove a Contact from Your Personal Directory

### Procedure

---

- Step 1** Press **Contacts** .
  - Step 2** Press **Contacts**.
  - Step 3** Sign in to your personal directory.
  - Step 4** Select **Personal Address Book** and search for an entry.
  - Step 5** Press **Select**, then **Edit**, then **Delete**.
  - Step 6** Press **OK** to confirm the deletion.
-



## Delete a Fast-Dial Code

### Procedure

---

- Step 1** Press **Contacts** .
  - Step 2** Press **Contacts**.
  - Step 3** Sign in to your personal directory.
  - Step 4** Select **Personal Fast Dials** and search for a fast-dial code.
  - Step 5** Select the required code and press **Remove**.
  - Step 6** Select the index and press **Remove**.
- 

## Cisco Web Dialer

You can use Cisco Web Dialer, a web browser, and your Cisco IP phone to make calls from web and desktop applications. Use your web browser and go to a website or your company directory, and then click a hyperlinked phone number to begin your call.

You need a user ID and password to make a call. Your administrator can give you this information. First-time users have to configure their preferences before a call.

For more information, see the “Cisco Web Dialer” document in <https://www.cisco.com/c/en/us/support/unified-communications/unified-communications-manager-callmanager/products-installation-and-configuration-guides-list.html>





## CHAPTER 4

# Recent Calls

---

- [Recent Calls List, on page 93](#)
- [View Your Recent Calls, on page 93](#)
- [Return a Recent Call, on page 94](#)
- [Clear the Recent Calls List, on page 94](#)
- [Delete a Call Record , on page 94](#)

## Recent Calls List

Use the Recents list to see the 150 most recent individual calls and call groups.

If your Recents list reaches the maximum size, the next new entry overwrites the oldest entry in the list.

Calls in the Recents list are grouped if they are to and from the same number and are consecutive. Missed calls from the same number also get grouped.

If you use a hunt group, then note the following:

- If your phone is part of a broadcast hunt group, calls picked up by other members of the hunt group display in your call history as a Received call.
- In the call history list, you see the term **Hunt group:** followed by the hunt group name or number, or both. This improvement helps you identify hunt group calls.

If your administrator configures the hunt group name, both the hunt group name and number display in the call history list. Otherwise, only the hunt group number displays.

## View Your Recent Calls

Check to see who's called you recently.

### Procedure

---

- Step 1** Press **Applications** .
- Step 2** Select **Recents**.

When the phone is in the idle state, you can also view the Recent calls list by pressing the Navigation cluster up.

**Step 3** If you have more than one line, select a line to view.

If two lines on your phone are configured for the same number, only the line that receives the call shows the call details in the call history.

---

## Return a Recent Call

You can easily call someone who has called you.

### Procedure

---

**Step 1** Press **Applications** .

**Step 2** Select **Recents**.

**Step 3** (Optional) Select **All lines** or the required line.

**Step 4** Select the number that you want to dial.

**Step 5** (Optional) Press **EditDial** to edit the number.

**Step 6** Press **Call**.

---

## Clear the Recent Calls List

You can clear the Recents list on your phone.

### Procedure

---

**Step 1** Press **Applications** .

**Step 2** Select **Recents**.

**Step 3** (Optional) Select **All Lines** or the required line.

**Step 4** Press **Clear**.

**Step 5** Press **Delete**.

---

## Delete a Call Record

You can edit Recents to remove a single call from your history. This helps preserve important contact information because Recents holds only 150 calls.

## Procedure

---

- Step 1** Press **Applications** .
- Step 2** Select **Recents**.
- Step 3** (Optional) Select **All Lines** or the required line.
- Step 4** Highlight the individual record or call group that you want to delete.
- Step 5** Press **Delete**.
- Step 6** Press **Delete** again to confirm.
-





## CHAPTER 5

# Applications

---

- [Available Applications](#), on page 97
- [View Active Applications](#), on page 97
- [Switch to Active Applications](#), on page 97
- [Close Active Applications](#), on page 98

## Available Applications

Cisco phones don't include these applications by default. But your company might have added applications such as the weather, stock information, company news, to-do lists, or similar information and services.

## View Active Applications

You can easily see what applications you already have open.

### Procedure

---

- Step 1** Press **Applications** .
  - Step 2** Press **Settings**.
  - Step 3** Select **Running applications**.
  - Step 4** Press **Exit**.
- 

## Switch to Active Applications

### Procedure

---

- Step 1** Press **Applications** .
- Step 2** Press **Settings**.

- Step 3** Select **Running applications**.
  - Step 4** Select a running application and press **Switch to** to open and use the selected application.
  - Step 5** Press **Exit**.
- 

## Close Active Applications

### Procedure

---

- Step 1** Press **Applications** .
  - Step 2** Press **Settings**.
  - Step 3** Select **Running applications**.
  - Step 4** Select a running application and press **Close app** to close the application.
  - Step 5** Press **Close**, then press **Exit**.
-





## CHAPTER 6

# Settings

---

- [Settings Menu](#), on page 99
- [Adjust the Volume During a Call](#), on page 105
- [Adjust the Phone Ringer Volume](#), on page 106
- [Phone Display Language](#), on page 106

## Settings Menu

You can control some attributes and features on your phone from the **Settings** menu.

## Change the Wallpaper

Your administrator may allow you to change the wallpaper or background image.

Wallpapers are supported on both your Cisco IP Phone and your key expansion module, if you have one attached to your phone.

### Procedure

---

- Step 1** Press **Applications** .
- Step 2** Navigate **Settings > Wallpaper**.
- Step 3** Select a wallpaper option and perform any of the steps:
- Press **Preview** to see the wallpaper on your phone screen.
  - Press **Set** to apply the wallpaper to the phone.
- Step 4** Press **Exit**.
- 

## Change the Ringtone

You can change the sound that your phone uses for incoming calls.

### Procedure

---

- Step 1** Select **Settings** > **Preferences** > **Ringtone**.
  - Step 2** Press **Applications** .
  - Step 3** Select **Settings** > **Ringtone**.
  - Step 4** Select a line.
  - Step 5** Scroll through the list of ringtones and press **Play** to hear a sample.
  - Step 6** Press **Set** to use the ringtone.
- 

## Adjust the Screen Brightness

You can change the brightness of the phone screen to make it easier to read.

### Procedure

---

- Step 1** Press **Applications** .
  - Step 2** Select **Settings** > **Brightness**.
  - Step 3** Press the Navigation cluster left to decrease, or right to increase, the brightness.
  - Step 4** Press **Save**.
- 

## Adjust the Contrast

You can change the contrast of your Cisco IP Phone 8811 to make the screen easier to read.

To check which phone model you have, press **Applications**  and select **Phone information**. The **Model number** field shows your phone model.

### Procedure

---

- Step 1** Press **Applications** .
  - Step 2** Select **Settings** > **Contrast**.
  - Step 3** Select **Contrast**.
  - Step 4** Press the Navigation cluster left to decrease, or right to increase the contrast.
  - Step 5** Press **Save** to set the contrast.
-

## Change the Font Size

You can change the font size on your phone to make the screen easier to read. However, if you increase the font size, some messages might be truncated.

The font size affects the following labels:

- call screen (caller name and feature key labels)
- caller name in Recents
- line labels on the phone screen

### Procedure

---

- Step 1** Press **Applications** .
- Step 2** Select **Settings** > **Font Size**.
- Step 3** Select a font size and press **Set**.
- Step 4** Press **Exit** to return to the **Applications** window.
- 

## Change the Phone Name

You can change the name of the phone from the default name. Your mobile device displays this name when you pair your mobile device with your desk phone.

### Procedure

---

- Step 1** Press **Applications** .
- Step 2** Select **Settings** > **Phone name**.
- Step 3** Use the keypad to enter a name.
- Step 4** Press **Apply**.
- Step 5** Press **Exit**.
- 

## Video Settings

If you have a video phone, you have settings to control the video.

### Adjust the Video Brightness

If the lighting in your office makes it hard to see the video, you can adjust the brightness.

### Procedure

---

- Step 1** Turn the ring around the camera clockwise to open the shutter.
  - Step 2** Press **Applications** .
  - Step 3** Select **Settings > Video > Exposure**.
  - Step 4** Press the Navigation cluster left to decrease, or right to increase, the brightness.
  - Step 5** Press **Save**.
- 

## Adjust the Video Bandwidth

During a video call, your video can suddenly stop or lag behind the audio. The lag is often caused by a busy network.

By default, your phone automatically selects a bandwidth setting that balances the audio and video network requirements. If you frequently see a video lag, you can select a fixed bandwidth. We suggest that you start at the lowest setting, and only increase the setting if the video lag continues.

### Procedure

---

- Step 1** Press **Applications** .
  - Step 2** Select **Settings > Video > Bandwidth**.
  - Step 3** Select a bandwidth setting.
  - Step 4** Press **Save** to set the bandwidth.
- 

## View Video Calls on Your Computer

You can view the video part of a call on your computer instead of the phone screen. The audio part of the call remains on your phone.

You cannot use desk phone video capabilities on a phone if a video camera is attached, such as a Cisco IP Phone 8845 or 8865.

### Before you begin

Connect the computer to the PC port of your phone with an Ethernet cable, and login to Cisco Jabber for Windows or Cisco Jabber for Mac. The phone must be connected to the first network interface card (NIC1) in the computer.

The phone PC port is disabled when Wi-Fi is enabled on your phone.

You need the latest version of Cisco Media Services Interface (MSI) and one of the following products:

- Cisco Jabber for Windows 9.7(5) or later
- Cisco Jabber for Mac 10.8.1 or later

Contact your administrator if you do not have the latest version of Cisco Jabber or MSI. For a list of hardware and software requirements, see:

- Cisco Jabber for Windows release notes at <http://www.cisco.com/c/en/us/support/unified-communications/jabber-windows/products-release-notes-list.html>.
- Cisco Jabber for Mac release notes at <http://www.cisco.com/c/en/us/support/unified-communications/jabber-mac/products-release-notes-list.html>

### Procedure

---

- Step 1** Press **Applications** .
- Step 2** Select **Settings** > **Video**.
- Step 3** Select **Video through computer**.
- Step 4** Select **On** to enable the video.
- 

## Turn Off the Lower Your Voice Alert

If you speak in a loud voice, you can set your phone to remind you to speak at an appropriate level. When you speak loudly (over a predefined threshold), a warning message is displayed on the phone screen. A tone plays when you speak loudly after the first warning.

You should lower your voice or select **Ignore** to dismiss the message.

Your administrator can enable or disable this feature. When disabled, you don't see the message or the item in the **Settings** menu.

When enabled by your administrator, the Lower Your Voice is enabled by default on your phone, but you can turn it on. It is available for handsets and headsets only.

### Procedure

---

- Step 1** Press **Applications** .
- Step 2** Navigate **Settings** > **Lower your voice**.
- Step 3** Press **Off**.
- Step 4** Press **Ok** on the pop-up window.
- 

## Enable Voice Feedback from Accessibility

You can enable or disable the Voice Feedback feature by pushing the Select button on the Navigation ring three times. But you can also access this feature from the Accessibility setting on your phone.

With Voice Feedback enabled, you press your Softkey buttons twice to use or configure a feature.

### Procedure

---

- Step 1** Press **Applications** .
  - Step 2** Select **Accessibility** > **Voice Feedback**.
  - Step 3** Select **On** to enable the feature.
  - Step 4** Select **Exit** twice to save your settings and return to Applications.
- 

### Related Topics

[Voice Feedback](#), on page 37

## Adjust Voice Speed

You can customize the speed of Voice Feedback if it reads too quickly or too slowly. Voice Feedback must be enabled before you can select a Voice Speed.

### Procedure

---

- Step 1** Press **Applications** .
  - Step 2** Select **Accessibility** > **Voice Speed**.
  - Step 3** Press the Navigation cluster up and down to navigate. Press **Select** to choose a speed.
  - Step 4** Select **Save** twice to save your settings and return to Accessibility.
  - Step 5** Select **Exit** twice to return to Applications.
- 

### Related Topics

[Voice Feedback](#), on page 37

## Turn Off the Select Key LED for Energy Save Mode

You can turn off the **Select** button LED when in Power Save mode. This reduces visual distractions in your workplace.

The **Select** button is in the middle of the Navigation cluster on your phone. The **Select** button LED is on by default when you are in Power save mode.

### Procedure

---

- Step 1** Press **Applications** .
  - Step 2** Choose **Settings** > **Power save indicator**.
  - Step 3** Press **Off** to turn off the LED.
  - Step 4** At the warning window, press **Ok**.
-

## Associate Your Headset with Your User Information

You can associate your headset with your sign-in ID from your phone. The association helps you use Extension Mobility.

If you need to remove the headset association, contact your administrator. You can't change or update your headset association from the phone menu.



---

**Note** If the headset is upgrading or you're on a call, the association can't be made. Wait until the upgrade is finished or the call is finished before you perform this procedure.

---

### Before you begin

- The Cisco Headset 500 Series connects to the phone with the USB or Y-cable, or is paired and connected to the phone through the Cisco Headset 560 Series Standard Base or Cisco Headset 560 Series Multibase. The Cisco Headset 730 connects to the phone with the USB or is paired by the Cisco Headset USB HD Adapter.
- A headset firmware upgrade can't be in progress.
- The phone must be idle.

### Procedure

---

- Step 1** On your desk phone, press **Applications** .
- Step 2** Select **Accessories > Cisco Headset > Setup > Associate user**.
- Step 3** Enter your User ID and PIN.
- Step 4** Press **Submit**.
- 

### Related Topics

[Sign into Extension Mobility with Your Cisco Headset](#), on page 19

## Adjust the Volume During a Call

If the sound in your handset, headset, or speakerphone is too loud or too soft, you can change the volume while you are listening to the other person. When you change the volume during a call, the change only affects the speaker you're using at the time. For example, if you adjust the volume while you're using a headset, the handset volume doesn't change.

### Procedure

---

- Step 1** Press **Volume**  right or left to adjust the volume while you are on a call.

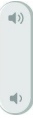
- Step 2** Press **Volume**  up or down to adjust the volume while you are on a call.
- 

## Adjust the Phone Ringer Volume

If your phone ringer is too loud or too soft when you get an incoming call, you can change the ringer volume. Changes to the ringer volume do not affect the call volume you hear when you are on a call.

### Procedure

---

- Step 1** Press **Volume**  right or left to adjust the ringer volume when the phone rings.

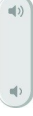
- Step 2** Press **Volume**  up or down to adjust the volume when the phone is not in use.
- 

## Phone Display Language

Your phone can display text in many languages. Your administrator sets the language the phone uses. If you want the language changed, contact your administrator.





# CHAPTER 7

## Accessories

- [Supported Accessories](#), on page 107
- [Check Your Phone Model](#), on page 109
- [View the Accessories Associated with Your Phone](#), on page 110
- [Headsets](#), on page 110
- [Cisco IP Phone 8800 Key Expansion Module](#), on page 143
- [Silicone Covers](#), on page 148

## Supported Accessories

You can use your phone with different types of accessories, such as headsets, microphones, and speakers. The tables in this section shows the accessories supported by your phone.

The following table describes the Cisco accessories available for the Cisco IP Phone 8800 Series.

**Table 25: Cisco Accessories for the Cisco IP Phone 8800 Series**

Accessory	Type	8811	8841	8845	8851	8851NR	8861	8865	8865NR
Cisco IP Phone 8800 Key Expansion Module	Add-on module	Not Supported	Not Supported	Not Supported	2	2	3	3	3
Cisco IP Phone 8851/8861 Key Expansion Module	Add-on module	Not Supported	Not Supported	Not Supported	Supported Supports up to 2 expansion modules of the same type.	Supported Supports up to 2 expansion modules of the same type.	Supported Supports up to 3 expansion modules of the same type.	Not Supported	Not Supported

## Supported Accessories

Accessory	Type	8811	8841	8845	8851	8851NR	8861	8865	8865NR
Cisco IP Phone 8865 Key Expansion Module	Add-on module	Not Supported	Not Supported	Not Supported	Not Supported	Not Supported	Not Supported	Supported Supports up to 3 expansion modules of the same type.	Supported Supports up to 3 expansion modules of the same type.
Wall Mount Kit	Add-on module	Supported	Supported	Supported	Supported	Supported	Supported	Supported	Supported
Cable Lock	Add-on module	Supported	Supported	Supported	Supported	Supported	Supported	Supported	Supported
Footstand	Add-on module	Supported	Supported	Supported	Supported	Supported	Supported	Supported	Supported
Silicone Case	Phone Case	Supported	Supported	Supported	Supported	Supported	Supported	Supported	Supported
Cisco Headset 520 Series	USB	Not Supported	Not Supported	Not Supported	Supported	Supported	Supported	Supported	Supported
Cisco Headset 530 Series	Standard	Supported	Supported	Supported	Supported	Supported	Supported	Supported	Supported
Cisco Headset 530 Series	USB Adapter	Not Supported	Not Supported	Not Supported	Supported	Supported	Supported	Supported	Supported
Cisco Headset 560 Series	Standard	Supported	Supported	Supported	Supported	Supported	Supported	Supported	Supported
Cisco Headset 560 Series	USB Adapter	Not supported	Not supported	Supported	Supported	Supported	Supported	Supported	Supported
Cisco Headset 720 Series	USB Adapter	Not supported	Not supported	Not supported	Supported	Supported	Supported	Supported	Supported
Cisco Headset 720 Series	Bluetooth	Not supported	Not supported	Supported	Supported	Not supported	Supported	Supported	Not supported
Cisco Headset 730	USB Adapter	Not supported	Not supported	Not supported	Supported	Supported	Supported	Supported	Supported

Accessory	Type	8811	8841	8845	8851	8851NR	8861	8865	8865NR
Cisco Headset 730	Bluetooth	Not supported	Not supported	Supported	Supported	Not supported	Supported	Supported	Not supported
Bang & Olufsen Cisco 980	USB Adapter	Not supported	Not supported	Not supported	Supported	Supported	Supported	Supported	Supported
Bang & Olufsen Cisco 980	Bluetooth	Not supported	Not supported	Supported	Supported	Not supported	Supported	Supported	Not supported

The following table describes the third party accessories available for the Cisco IP Phone 8800 Series.

**Table 26: Third Party Accessories for the Cisco IP Phone 8800 Series**

Accessory	Type	8811	8841	8845	8851	8851NR	8861	8865	8865NR
Headset	Analog	Supported	Supported	Supported	Supported	Supported	Supported	Supported	Supported
Headset	Analog Wideband	Supported	Supported	Supported	Supported	Supported	Supported	Supported	Supported
Headset	Bluetooth	Not supported	Not supported	Supported	Supported	Not supported	Supported	Supported	Not supported
Headset	USB	Not supported	Not supported	Not supported	Supported	Supported	Supported	Supported	Supported
Microphone	External PC	Not supported	Not supported	Not supported	Not supported	Not supported	Supported	Supported	Supported
Speakers	External PC	Not supported	Not supported	Not supported	Not supported	Not supported	Supported	Supported	Supported

## Check Your Phone Model

It is important to know your phone model because each phone supports a different set of accessories.

### Procedure

- 
- Step 1** Press **Applications** .
- Step 2** Select **Phone information**. The **Model number** field shows your phone model.
-

## View the Accessories Associated with Your Phone

You can use the headset jack, Bluetooth, or the USB port to connect external hardware to your phone. The accessory list, by default, contains an analog headset that can be set up to enable wideband

### Procedure

---

- Step 1** Press **Applications** .
- Step 2** Select one of the following options:
- **Accessories**
  - **Bluetooth**
- Step 3** (Optional) Select an accessory and press **Show detail**.
- Step 4** Press **Exit**.
- 

## Headsets

There are a number of Cisco and third party headsets available for use on your Cisco IP Phones and devices. For additional information about Cisco headsets, see <https://www.cisco.com/c/en/us/products/collaboration-endpoints/headsets/index.html>.

### Related Topics

[Supported Accessories](#), on page 107

## Important Headset Safety Information



**High Sound Pressure**—Avoid listening to high volume levels for long periods to prevent possible hearing damage.

When you plug in your headset, lower the volume of the headset speaker before you put the headset on. If you remember to lower the volume before you take the headset off, the volume will start lower when you plug in your headset again.

Be aware of your surroundings. When you use your headset, it may block out important external sounds, particularly in emergencies or in noisy environments. Don't use the headset while driving. Don't leave your headset or headset cables in an area where people or pets can trip over them. Always supervise children who are near your headset or headset cables.

## Cisco Headset 500 Series

The following Cisco headsets are available:

- Cisco Headset 521—A headset with a single earpiece that comes with an inline USB controller.

- Cisco Headset 522—A headset with a dual earpiece that comes with an inline USB controller.
- Cisco Headset 531—A headset with a single earpiece that can be used as either a standard headset or a USB headset with the USB adapter.
- Cisco Headset 532—A standard headset with a dual earpiece that can be used as either a standard headset or a USB headset with the USB adapter.
- Cisco Headset 561—A wireless headset with a single earpiece that comes with a base.
- Cisco Headset 562—A wireless headset with a dual earpiece that comes with a base.

### Cisco Headset 521 and 522

The Cisco Headset 521 and 522 are two wired headsets that have been developed for use on Cisco IP Phones and devices. The Cisco Headset 521 features a single earpiece for extended wear and comfort. The Cisco Headset 522 features two earpieces for use in a noisy workplace.

Both headsets feature a 3.5-mm connector for use on laptops and mobile devices. An inline USB controller is also available for use on the Cisco IP Phone 8851, 8851NR, 8861, 8865, and 8865NR. The controller is an easy way answer your calls, and to access basic phone features such as hold and resume, mute, and volume control.

Phone Firmware Release 12.1(1) and later is required for these headsets to function properly.

**Figure 10: Cisco Headset 521**



**Figure 11: Cisco Headset 522**



### Cisco Headset 531 and 532

The Cisco Headset 531 and 532 can be used as standard headsets on the phones. You plug the headset into the headset port using the RJ connector.

The Cisco Headset USB Adapter is also available for use on the Cisco IP Phone 8851, 8851NR, 8861, 8865, and 8865NR. The adapter converts the Cisco Headset 531 and 532 into a USB headset, and it gives you a few extra features. It provides a convenient way to handle calls, to test your microphone, and to customize your bass and treble, gain, and sidetone settings.

Phone Firmware Release 12.1(1) and later is required for the headsets to function properly.

**Figure 12: Cisco Headset 531**



**Figure 13: Cisco Headset 532**



### Cisco Headset 561 and 562

Cisco Headset 561 and 562 are two wireless headsets that have been developed for use in today's office. The Cisco Headset 561 features a single earpiece for extended wear and comfort. Cisco Headset 562 features two earpieces for use in a noisy workplace.

Both headsets come with either the Standard base or the Multibase for charging your headset, and for monitoring the headset power level with the LED display. Both bases also displays your call status, such as incoming call, active call, and calls on mute. If your headset is upgrading the firmware, then the LEDs show the upgrade progress.

The base connects to the phone using either a USB connector or a Y cable depending upon your phone model and your personal preference. The Y cable plugs into the AUX and headset ports of the phone.

An AC plug is included for connecting the base to a power outlet. You have to install the power clip for your region before you can plug in the power adapter.

Occasionally a tone is played over your Cisco Headset 561 or 562. Some of these tones alert you when you perform an action, such as pressing a button. Other tones warn you that the headset requires attention, such as when the battery needs recharging, or when you are too far from the base station.

Phone Firmware Release 12.5(1) or later and the defaultheadsetconfig.json file for the Cisco Headset 561 and 562 to function properly with Cisco Unified Communications Manager 12.5(1) or earlier.

**Figure 14: Cisco Headset 561**



**Figure 15: Cisco Headset 562**



**Cisco Headset 500 Series Support**

The Cisco IP Phone 8800 Series has both RJ-style connectors and USB ports to connect to headsets and bases to a phone. But the type of connection depends upon your phone model. The following table describes headset connection and phone model support on the Cisco IP Phone 8800 Series.

**Table 27: Headset Support on the Cisco IP Phone 8800 Series.**

<b>Cisco Headset 500 Series</b>	<b>Cisco IP Phone 8811</b> <b>Cisco IP Phone 8841</b> <b>Cisco IP Phone 8845</b>	<b>Cisco IP Phone 8851</b> <b>Cisco IP Phone 8851NR</b> <b>Cisco IP Phone 8861</b> <b>Cisco IP Phone 8865</b> <b>Cisco IP Phone 8865NR</b>
Cisco Headset 521 Cisco Headset 522	Not Supported	Supported (With USB Inline Controller)

<b>Cisco Headset 500 Series</b>	<b>Cisco IP Phone 8811</b> <b>Cisco IP Phone 8841</b> <b>Cisco IP Phone 8845</b>	<b>Cisco IP Phone 8851</b> <b>Cisco IP Phone 8851NR</b> <b>Cisco IP Phone 8861</b> <b>Cisco IP Phone 8865</b> <b>Cisco IP Phone 8865NR</b>
Cisco Headset 531 Cisco Headset 532	Supported (RJ connector)	Supported (RJ connector or with USB Adapter)
Cisco Headset 561 Cisco Headset 562	Supported (Y-cable)	Supported (Y-cable or USB cable)

**Related Topics**

[Cisco Headset Customization](#), on page 133

[Connect a Headset to Your Phone](#), on page 127

[Configure a Headset on the Phone](#), on page 130

**Cisco Headset 521 and 522 Controller Buttons and Hardware**

Your controller buttons are used for basic call features.

**Figure 16: Cisco Headset 521 and 522 Controller**

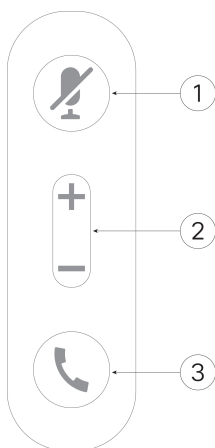

The following table describes the Cisco Headset 521 and 522 controller buttons.

**Table 28: Cisco Headset 521 and 522 Controller Buttons**

Number	Name	Description
1	Mute button	Toggle the microphone on and off.
2	Volume button	Adjust the volume on your headset.



Number	Name	Description
3	Call	Use to manage calls: <ul style="list-style-type: none"> <li>• Press once to answer an incoming call.</li> <li>• Press and hold to end a call.</li> <li>• Press twice to reject an incoming call.</li> <li>• Press once to put an active call on hold. Press again to retrieve a call from hold.</li> <li>• Press once to put an active call on hold, and to answer an incoming call.</li> </ul>

### Cisco Headset 531 and 532 USB Adapter Buttons and Hardware

Your adapter is used for basic call features.

**Figure 17: Cisco Headset USB Adapter**

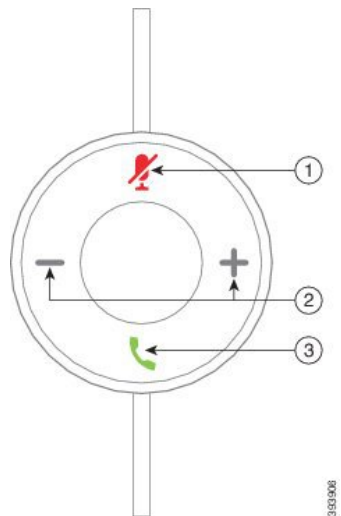

The following table describes the Cisco Headset USB Adapter buttons.

**Table 29: Cisco USB Adapter Buttons**

Number	Name	Description
1	Mute button	Toggle the microphone on and off.
2	Volume button	Adjust the volume on your headset.

Number	Name	Description
3	Call button	<p>Use to place, answer, and manage your calls:</p> <ul style="list-style-type: none"> <li>• Press once to place a call.</li> <li>• Press once to answer an incoming call. Press twice to reject an incoming call.</li> <li>• Press once to put an active call on hold, and to answer an incoming call.</li> <li>• Press once to put an active call on hold.</li> <li>• Press and hold to end a call.</li> </ul>

## Cisco Headset 561 and 562 Buttons and LED

Your headset buttons are used for basic call features.

*Figure 18: Cisco Headset 561 and 562 Headset Buttons*

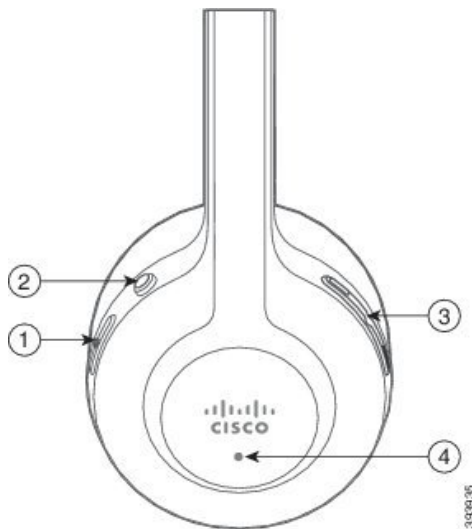

The following table describes the Cisco Headset 561 and 562 Headset buttons.

**Table 30: Cisco Headset 561 and 562 Headset Buttons**

Number	Name	Description
1	Power and Call button	<p>Use to power the headset on and off.</p> <p>Press and hold for 4 seconds to power on and off the headset.</p> <p>Incoming and active call management depends upon if you have one call or multiple calls.</p> <p>One call:</p> <ul style="list-style-type: none"> <li>• Press once to answer incoming calls.</li> <li>• Press once to put an active call on hold. Press again to retrieve a call from hold.</li> <li>• Press twice to reject an incoming call.</li> <li>• Press and hold to end an active call.</li> </ul> <p>Multiple calls:</p> <ul style="list-style-type: none"> <li>• Press once to put an active call on hold, and to answer a second incoming call.</li> <li>• Press once to put a current call on hold. Press again to resume a call, or press and hold for 2 seconds to end the current call and to resume a held call.</li> <li>• Press and hold to end an active call, and to answer another incoming call.</li> <li>• Press twice to stay on a current call, and to reject a second incoming call.</li> </ul>
2	Mute button	<p>Toggle the microphone on and off. The Mute  on the phone lights when Mute on the headset is enabled.</p>
3	Volume button	<p>Adjust the volume on your headset.</p>
4	LED	<p>Shows the headset status:</p> <ul style="list-style-type: none"> <li>• Blinking red—Incoming call.</li> <li>• Steady red—Active call.</li> <li>• Blinking white—Firmware upgrade is in progress.</li> </ul>

## Standard Base for Cisco Headset 561 and 562

The Cisco Headset 561 and 562 come with a standard base to charge your headset. The base's LED display shows the current battery level, and your call state.

In addition to the call control buttons on the headset, you can also answer and end calls when you lift or set down your headset on the base. To achieve the functions, ensure that the `End call on dock` and `Answer call on off-dock` are enabled on the phone. For more information, see [Change Call Behavior of On Dock or Off Dock](#), on page 134.

The connection between the base and the headset is made with Digital Enhanced Cordless Telecommunications (DECT).

**Figure 19: LED Display on the Standard Base for Cisco 561 and 562 Headset**

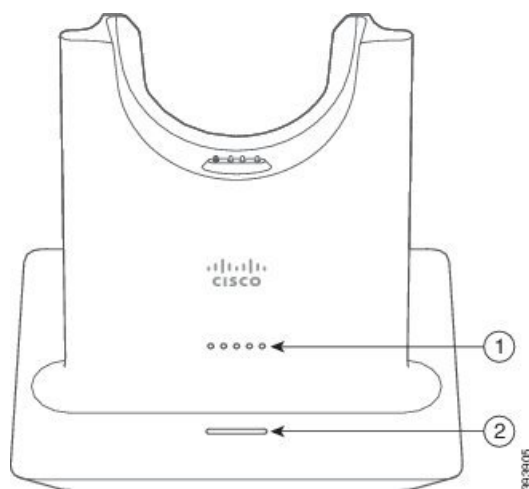

The following table describes the standard base for Cisco 561 and 562 Headset.

**Table 31: Standard Base for Cisco 561 and 562 Headset**

Number	Name	Description
1	Battery Status LED	Indicates the headset battery charge.
2	Call Status LED	Alerts you to the call state: <ul style="list-style-type: none"> <li>• Incoming call—Blinking green.</li> <li>• Active call—Steady green.</li> <li>• Muted call—Steady red.</li> </ul>

## Multibase for Cisco Headset 560 Series

The multibase can connect up to three call sources through Bluetooth<sup>®</sup>, the USB connector, or the Y-cable. The multibase can save up to four Bluetooth devices. You can switch between call sources using the buttons on the multibase.

You use the call control buttons on the headset to answer and end calls. By default, when your headset is in the base, you automatically answer the call when you remove the headset from the base. And you can return the headset to the base to end the call. If you want to change the call behavior, see [Change Call Behavior of On Dock or Off Dock](#), on page 134.

The multibase comes with the following connector cables:

- USB to USB cable: for Cisco IP phones with USB connectivity
- USB Y-cable: for Cisco IP phones without a USB port
- Mini USB cable: for PC or Mac.
- Mini USB to USB-C cable: available separately for PC or Mac devices.



**Note** The multibase for the Cisco Headset 560 Series is incompatible with Cisco IP Phone 7800 Series phones using Power over Ethernet (PoE). Use the external power supply if you intend to connect the multibase.

**Figure 20: Multibase LEDs**

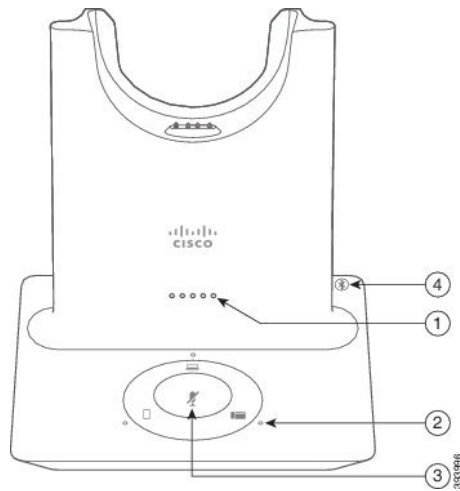

The following table describes the Cisco Headset 560 Series Multibase multibase LEDs.

**Table 32: Multibase LEDs**

Number	Name	Description
1	Battery status LED	<p>Indicates the headset battery charge and base status:</p> <ul style="list-style-type: none"> <li>• Headset battery strength—LEDs blink and change to solid as the battery charges</li> <li>• Headset update in progress—LEDs blink in sequence, left to right</li> <li>• Headset and base not paired—All LEDs blink</li> <li>• Power save mode—Middle LED shows solid</li> </ul> <p>The base enters power save mode when there is no call source connectivity after 10 minutes.</p>

Number	Name	Description
2	Call status LEDs	Alerts you to the call state of each source: <ul style="list-style-type: none"> <li>• Active Source—Steady white</li> <li>• Incoming call on a selected source—Blinks green</li> <li>• Incoming call on an unselected source—Blinks green</li> <li>• Active call—Steady green</li> <li>• Call on an inactive source—Pulses green</li> </ul>
3	Mute status LED	Alerts you when your headset is muted.
4	Bluetooth status LED	Alerts you to the Bluetooth status: <ul style="list-style-type: none"> <li>• Paired with a call source—Steady white</li> <li>• Pairing mode—Blinking white</li> <li>• Searching for a call source—Pulse white</li> <li>• Bluetooth is Off—LED is off</li> </ul>

You use the source control buttons on the base to control the active source. Each source button corresponds with a specific connection on the multibase.

Even if you are connected to a source, the LED may not be lit. The source LED only lights when the source is selected or has an active call. For example, you may be properly connected to a Cisco IP phone, your PC, and your mobile phone through Bluetooth. However, the respective source LED is only lit when it is selected, has an active call, or has an incoming call. Press the source button to check if a source is properly connected. The source LED flashes three times if there is no connection.

You can alternate between active call sources.







---

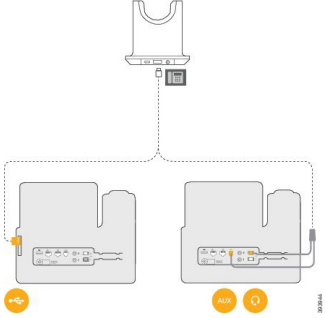

**Note** Place an active call on hold before you change to a different call source. Calls on one call source aren't automatically put on hold when you switch to a different call source.

---

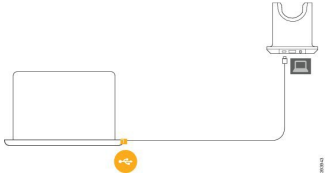
The following table illustrates the multibase source icons and their corresponding connections.

**Table 33: Multibase source console**

Source	Base icon	Connection
Desk phone		 <p data-bbox="1151 743 1474 772"><b>USB to USB cord or Y-cable</b></p> <p data-bbox="1151 793 1531 982">The desk phone icon corresponds with the middle USB port at the back of the multibase. It is intended for connecting to Cisco IP phones but it will function properly with any compatible call device.</p>
Laptop		 <p data-bbox="1151 1205 1338 1234"><b>Micro-USB cord</b></p> <p data-bbox="1151 1255 1531 1444">The laptop icon corresponds with the micro-USB port found on the back of the multibase. The micro-USB port is intended for connections with a laptop or desktop computer.</p>

Source	Base icon	Connection
Mobile		 <p>The mobile phone icon corresponds with the Bluetooth connection found at the back of the base. While the icon is of a mobile phone, the base will connect with any compatible Bluetooth call device.</p> <p>The multibase can save and remember up to four Bluetooth call devices.</p> <p>If you are listening to music through the Bluetooth source, the music pauses when you place the headset on the base.</p>

## Cisco Headset 700 Series

The Cisco Headset 700 Series is a wireless headset that uses Bluetooth connectivity to pair with Cisco soft clients and Cisco IP Phones.

The Cisco Headset 730 features full call control and music playback capabilities in addition to powerful noise cancellation and ambient audio enhancement systems for use in a busy office environment.

The Cisco Headset 720 Series features basic call control, local settings, and UCM serviceability.

For more information how the IP Phones are supported on the Cisco headsets, see [Cisco Headset Compatibility Guide](#).

For more information see <https://www.cisco.com/c/en/us/products/collaboration-endpoints/headset-700-series/index.html> and <https://www.webex.com/devices/cisco-headset-720-series.html>

## Cisco Headset 730 Buttons and Hardware

Your headset buttons are used for many features. Each cup has different buttons and functions.



Figure 21: Left and Right Sides of the Cisco Headset 730

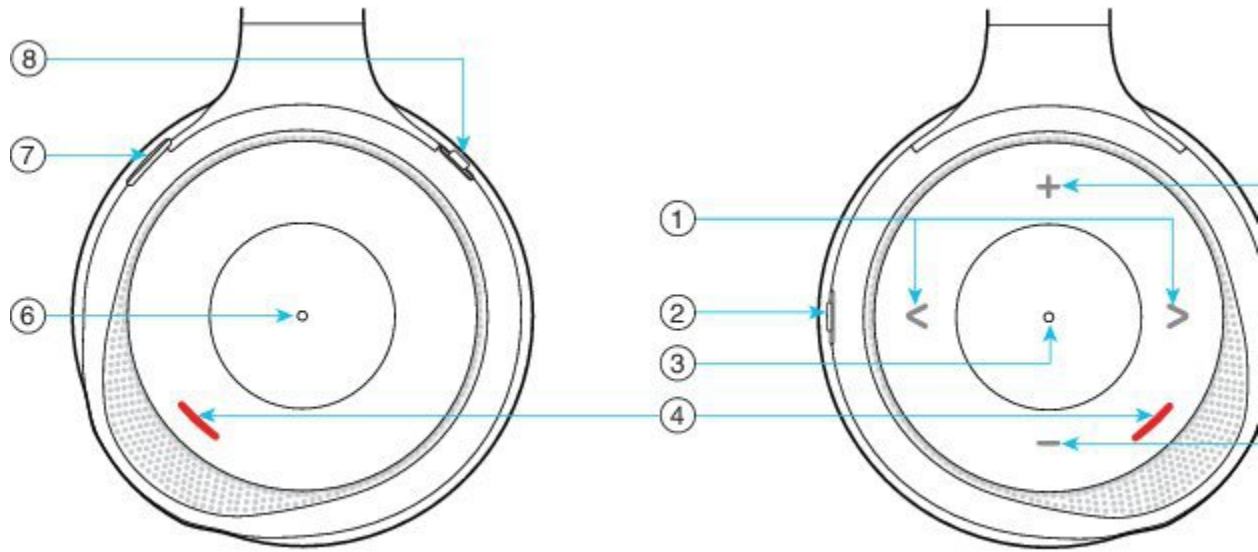









Table 34: Cisco Headset 730 Buttons

Callout Number	Name	Description
1	Skip music track This is the right and left of the right cup face.	Skip forward and backward through music tracks. Only available if you have the headset paired to a device that can play music.
		
2	AMB and NC button This button is located on the back of the right cup.	Three position switch: <ul style="list-style-type: none"> <li>• AMB: Slide to the top to enable ambient mode.</li> <li>• No ambient mode or noise cancellation: Middle position.</li> <li>• NC: Slide to the bottom to enable noise cancellation.</li> </ul>
		

Callout Number	Name	Description
3	<p>Pause and Play</p> <p>This is the center of the right cup and is marked with a dot.</p> 	<p>Press to play or to pause your music. Only available if you have the headset paired to a device that can play music.</p>
4	<p>Presence LED</p> <p>This LED is located on the face of the cup on both the right and left cup.</p> 	<p>Displays red when you are on a call or if you have pressed the Mute button on the headset when you aren't on a call.</p>
5	<p>Volume</p> <p>This is the top and bottom of the right cup face.</p> 	<p>Press the top or bottom to raise or lower the volume.</p>
6	<p>Call button</p> <p>This is the center of the left cup and is marked with a dot.</p>	<p>Controls the call functions, based on the call state:</p> <ul style="list-style-type: none"> <li>• Incoming calls <ul style="list-style-type: none"> <li>• Answer a call: Press once.</li> <li>• Reject a call: Press twice.</li> </ul> </li> <li>• Active calls <ul style="list-style-type: none"> <li>• Hold a call: Press once.</li> <li>• End a call: Press and hold until you hear a tone.</li> </ul> </li> </ul>

Callout Number	Name	Description
7	Mute This is the button on the front of the left cup.	Toggles the microphone on and off. When muted, the Presence LED lights red and the Mute  button on the phone lights. During an active call, the mute status is synchronized automatically between the IP Phone and the Cisco headset. This feature is supported on Cisco Headset 720 Series and Cisco Headset 730.
8	Bluetooth and Power button This is on the back of the left cup. 	Three position switch: <ul style="list-style-type: none"> <li>• Bluetooth: Slide to the top and hold to pair the headset to the phone.</li> <li>• Power: Slide to the middle position to turn the headset on. Slide down to turn the headset off.</li> </ul>

## Cisco Headset 720 Buttons and Hardware

For more information about Cisco Headset 720 Series (Webex version) buttons and hardware, see [Get started with your Cisco Headset 720 Series](#).



**Note** For the headset that is connected with the IP Phones, it supports basic call controls, local settings, and headset serviceability features on Cisco Unified Communications Manager. For more information, see [Cisco Headset Compatibility Guide](#).

## Bang & Olufsen Cisco 980 Buttons and Hardware

For more information about Bang & Olufsen Cisco 980 buttons and hardware, see [Get started with your Bang & Olufsen Cisco 980](#).



**Note** For the headset that is connected with the IP Phones, it only supports basic call controls. For more information, see [Cisco Headset Compatibility Guide](#).

## Third Party Headsets

Cisco performs internal testing of third-party headsets for use with Cisco IP Phones. But Cisco does not certify or support products from headset or handset vendors. Check with the headset manufacturer to confirm whether you can use it with your Cisco phone.

Headsets connect to your phone using either the USB or the auxiliary port. Depending upon your headset model, you have to adjust your phone's audio settings for the best audio experience, including the headset sidetone setting.

If you have a third party headset, and you apply a new sidetone setting, then wait one minute and reboot the phone so the setting is stored in flash.

The phone reduces some background noise that a headset microphone detects. You can use a noise canceling headset to further reduce the background noise and improve the overall audio quality.

If you are considering a third part headset, we recommend the use of good quality external devices; for example, headsets that are screened against unwanted radio frequency (RF) and audio frequency (AF) signals. Depending on the quality of headsets and their proximity to other devices, such as mobile phones and two-way radios, some audio noise or echo may still occur. Either the remote party or both the remote party and the Cisco IP Phone user may hear an audible hum or buzz. A range of outside sources can cause humming or buzzing sounds; for example, electric lights, electric motors, or large PC monitors.

Sometimes, use of a local power cube or power injector may reduce or eliminate hum.

Environmental and hardware inconsistencies in the locations where Cisco IP Phones are deployed mean that no single headset solution is optimal for all environments.

We recommend that customers test headsets in the intended environment to determine performance before making a purchasing decision to deploy on a large scale.

You can use only one headset at a time. The most-recently connected headset is the active headset.

For a list of suggested headsets and other audio accessories, see [http://www.cisco.com/c/en/us/products/unified-communications/uc\\_endpoints\\_accessories.html](http://www.cisco.com/c/en/us/products/unified-communications/uc_endpoints_accessories.html).

## Bluetooth Headsets

You can use a Bluetooth headset for your calls if your phone supports Bluetooth.

When you use Bluetooth headsets with your phone, keep in mind:

- If you have both a Bluetooth headset and a standard headset attached to the phone, only one type of headset works at any time. When you enable one headset, the other is automatically disabled.
- If you use a USB headset, both the Bluetooth and analog headset are disabled. If you unplug the USB headset, you need to enable the Bluetooth or standard headset.
- For optimum headset coverage, use your Bluetooth headset within 10feet (3meters) of the phone.
- Your phone supports the Bluetooth Handsfree Profile. If your Bluetooth headset supports these features, you can use your headset to:
  - Answer a call
  - End a call
  - Change the headset volume for a call
  - Redial a number

- View Caller ID
- Reject a call
- Divert a call
- Place a call on hold by answering an incoming call
- End a call by answering an incoming call

For more information, see the documentation from your Bluetooth headset manufacturer.

#### Related Topics

[Configure a Headset on the Phone](#), on page 130

## Audio Quality

Beyond physical, mechanical, and technical performance, the audio portion of a headset must sound good to the user and to the party on the far end. Sound quality is subjective, and we cannot guarantee the performance of any third-party headset. However, various headsets from leading headset manufacturers are reported to perform well with Cisco IP Phones.

Cisco doesn't recommend or test any third-party headsets with their products. For information about third-party headset support for Cisco products, go to the manufacturer's web site.

Cisco does test the Cisco headsets with the Cisco IP Phones. For information about Cisco Headsets and Cisco IP Phone support, see <https://www.cisco.com/c/en/us/products/collaboration-endpoints/headsets/index.html>.

## Wired Headsets

A wired headset works with all Cisco IP Phone features, including the Volume and Mute buttons. These buttons adjust the earpiece volume and mute the audio from the headset microphone.

When you install a wired headset, make sure you press the cable into the channel in the phone.



---

**Caution** Failure to press the cable into the channel in the phone can lead to cable damage.

---

## Wireless Headsets

You can use most wireless headsets with your phone. For a list of supported wireless headsets, see [http://www.cisco.com/c/en/us/products/unified-communications/uc\\_endpoints\\_accessories.html](http://www.cisco.com/c/en/us/products/unified-communications/uc_endpoints_accessories.html)

Refer to your wireless headset documentation for information about connecting the headset and using the features.

## Connect a Headset to Your Phone

Each type of wired headset, adapter, or base connects to a phone using a different port and a different type of connector and cable. Common types include an RJ connector, a USB connector, and a Y-cable.

## Connect a Standard Headset

You can use a standard headset with your desk phone. Standard headsets plug into the headset jack on the back of the phone with an RJ-type connector.

**Figure 22: Standard Headset Connection**

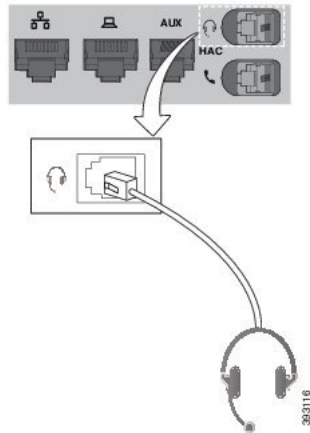

**Caution** Failure to press the cable into the channel in the phone can damage the printed circuit board inside the phone. The cable channel reduces the strain on the connector and the printed circuit board.

### Procedure

---

Plug the headset into the headset jack on the back of the phone. Press the cable into the cable channel.

---

## Connect a USB Headset

When you use USB headsets with your phone, keep in mind the following:

- You can use only one headset at a time. The most-recently connected headset is the active headset.
- If you are on an active call and unplug a USB headset, the audio path does not change automatically. Press the **Speakerphone** button or pick up the handset to change the audio.

Your phone may have more than one USB port, depending upon your model. The Cisco IP Phone 8851 and 8851NR has one USB located on the side of the phone. The Cisco IP Phone 8861, 8865, and 8865NR have two USB ports, located on the back and side of the phone.

You may have to remove the plastic cover to access the side USB ports.

### Procedure

---

Plug the USB headset connector into the USB port on the phone.

---

## Connect a Cisco Standard Base with the Y-Cable

You can connect the standard base to your phone with the included Y-cable. But note that the Y-cable has two RJ-type connectors - one for the auxiliary or AUX port, and one for the headset port. You can distinguish between the two connectors by their size, as the AUX port connector is slightly larger than the headset port connector.



**Caution** Failure to press the cable into the channel in the phone can damage the printed circuit board inside the phone. The cable channel reduces the strain on the connector and the printed circuit board.

---

### Procedure

---

- Step 1** Plug the smaller connector into the headset jack that is located on the back of the phone. Press the cable into the cable channel.
- Step 2** Plug the larger cable into the AUX port located next to the headset port.
- 

## Connect the multibase to a Bluetooth device

The multibase for the Cisco Headset 560 Series can connect to Bluetooth® devices such as a mobile phone or tablet. The headset base appears on your call device as **Cisco Headset** followed by the last three digits on your headset serial number.



**Note** You can find your headset serial number in the lower right corner on the underside of your base.

---

The multibase can store up to four different paired Bluetooth devices. If you already have four paired devices, the base will replace the device which has not been used in the longest time.

### Procedure

---

- Step 1** Press the **Bluetooth** button on the back of the base twice to start pairing.
- Step 2** Select your headset from the **Settings** menu on your device.
- The Bluetooth LED lights white when pairing is successful.
-

## Disconnect the Multibase from a Bluetooth Device

You can disconnect your Multibase from its paired Bluetooth call device.

### Procedure

---

- Step 1** Press the **Bluetooth button** on the back of the base once. The LED may take a moment to turn off.
- Step 2** Press the **Bluetooth button** again to reconnect to the same call device.
- 

## Erase all Bluetooth pairings

You can erase all saved Bluetooth® device pairings.

### Procedure

---

Press and hold the **Bluetooth** button on the back of the multibase for four seconds to clear the memory.

---

## Configure a Headset on the Phone

After you have connected the headset, you may have to configure it on your phone.

If you have a Cisco headset with a USB adapter, then follow the steps in [Cisco Headset Customization](#), on [page 133](#)

## Reset Cisco Headset settings from your phone

You can reset your Cisco headset to remove your custom settings. This action returns the headset to the original configuration set by your administrator.

Your phone must be running firmware release 12.5(1)SR3 or later for this feature to function.

### Before you begin

Connect your headset to the phone:

- Cisco Headset 520 Series: Connect with the USB adapter
- Cisco Headset 530 Series: Connect with the USB cable
- Cisco Headset 560 Series: Connect the standard base or multibase with the USB or Y-cable.

### Procedure

---

- Step 1** On the phone, press **Applications** .
- Step 2** Select **Accessories > Setup > Reset settings**.



- Step 3** At the warning window, select **Reset**.
- 

## Adjust the Headset Feedback

When you use a headset, you can hear your own voice in the earpiece, which is called headset sidetone or headset feedback. You can control the amount of headset sidetone on your phone.

### Procedure

---

- Step 1** Press **Applications** .
- Step 2** Select **Settings** > **Headset sidetone**.
- Step 3** Select a setting.
- 

## Turn Bluetooth On or Off

When Bluetooth is active, the Bluetooth icon  appears in the phone screen header.

### Procedure

---

- Step 1** Press **Applications** .
- Step 2** Select **Bluetooth**.
- Step 3** Press **On** or **Off**.
- 

## Add a Bluetooth Headset

### Procedure

---

- Step 1** Make your Bluetooth headset discoverable.
- Step 2** Press **Applications** .
- Step 3** Select **Bluetooth** > **Add Bluetooth device**.  
Your phone searches for discoverable accessories.
- Step 4** Select your headset and press **Connect**.
- Step 5** (Optional) If prompted, enter the PIN for your headset.
- 

## Disconnect a Bluetooth Headset

You should disconnect your Bluetooth headset before you use it with another device.

### Procedure

---

- Step 1** Press **Applications** .
  - Step 2** Select **Bluetooth**.
  - Step 3** Select a Bluetooth headset.
  - Step 4** Press **Disconnect**.
- 

## Remove a Bluetooth Headset

Remove your Bluetooth headset if you aren't going to use it with your phone again.

### Procedure

---



- Step 1** Press **Applications** .
  - Step 2** Select **Bluetooth**.
  - Step 3** Select a Bluetooth headset and press **Delete**.
- 

## Set Up a Wideband Standard Headset

You can use a headset that supports wideband audio. Wideband audio improves the quality of the sound you hear in the headset.

### Procedure

---

- Step 1** Press **Applications** .
  - Step 2** Select **Accessories > Analog headset > Setup**.
  - Step 3** Press **On** or **Off** to enable or disable wideband for the analog headset.
  - Step 4** Press **Return** .
- 

## Enable electronic hookswitch control on your phone

If your administrator has enabled **Admin settings** on your Cisco IP Phone, you can enable or disable electronic hookswitch control to connect with a Cisco Headset 560 Series base. Electronic hookswitch control is enabled by default.



---

**Note** This feature is available on Cisco IP Phone Firmware Release 12.7(1) and later.

---

### Procedure

---

- Step 1** On your phone, press **Applications** .
- Step 2** Navigate **Admin settings** > **Aux port**.
- Step 3** Select **Connect e-hook headset** to enable electronic hookswitch control.
- 

## Cisco Headset Customization

Some Cisco Headset 500 Series are available with a USB adapter that allows you to customize your settings. The headset retains the settings when you switch phones.

You can customize the Cisco Headset 730 headset settings. The headset retains the settings when you switch phones. Currently, you can only customise the settings when you have the headset connected to the phone with the USB-C cable.

You can customize your headset settings if you have one of the following Cisco headsets:

- Cisco Headset 521 and 522
- Cisco Headset 531 and 532
- Cisco Headset 561 and 562
- Cisco Headset 730

### Related Topics

[Cisco Headset 500 Series](#), on page 110

## Cisco Headset 500 Series Customization

### Adjust Your Bass and Treble

You can adjust the bass and treble to customize the headset sound. If you like a headset with a lot of bass, then adjust toward the warm setting. If you prefer more treble, then adjust toward the bright setting.

### Procedure

---

- Step 1** Press **Applications** .
- Step 2** Select **Accessories** and then your headset.
- Step 3** Navigate **Setup** > **Speaker** > **Tuning**.
- Step 4** Press the Navigation cluster left, or right, to adjust the tuning.
- 

### Adjust Your Speaker Sidetone

Sidetone is the term for when you hear your own voice in your headset. Some people find it distracting to hear their own voice during a call, while other people want to know that their headset is working.

### Procedure

---

- Step 1** Press **Applications** .
  - Step 2** Select **Accessories** and then your headset.
  - Step 3** Navigate **Setup > Speaker > Sidetone**.
  - Step 4** Press the Navigation cluster up or down to adjust the sidetone.
  - Step 5** Select **Set** to apply your settings.
- 

### Adjust Your Microphone Volume

Microphone volume is also known as gain, and this setting controls how loud you are to other people on the call.

### Procedure

---

- Step 1** Press **Applications** .
  - Step 2** Select **Accessories** and then your headset.
  - Step 3** Navigate **Setup > Microphone > Gain**.
  - Step 4** Press the Navigation cluster, left or right, to adjust the gain.
- 

### Change your headset ringer settings

You can change your headset ringtone behavior on Cisco IP phones with phone firmware 14.0 or later. The setting is saved on the phone and will apply to any Cisco Headset 500 Series that connects.

### Procedure

---

- Step 1** Press **Applications** .
- Step 2** Select **Preferences > Headset ringer**.
- Step 3** Select a ringer setting.

By default, your phone follows the behavior of the phone ringer settings. Select **On** if you want to always hear the phone ring when you have an incoming call. If you select **Off**, you won't hear any ring through your headset when there is an incoming call.

- Step 4** Select **Set** to apply your settings.
- 

### Change Call Behavior of On Dock or Off Dock

You can change the call behavior when you lift the headset from the base or when you put down the headset on the base.

## Procedure

---

- Step 1** Press **Applications** .
- Step 2** Select **Accessories** and then your headset.
- Step 3** Navigate **Setup > End call on dock**.
- Step 4** Select **On** or **Off** to enable or disable the feature.
- On** (Default): The active call is ended when you set down the headset on the base.
- Off**: The active call is still ongoing when you set down the headset on the base.
- Step 5** Navigate to **Answer call on off-dock**, and then select **On** or **Off** to enable or disable the feature.
- On** (Default): The incoming call is answered when you lift the headset from the base.
- Off**: The incoming call cannot be answered when you lift the headset from the base.
- 

## Enable Always On Mode

By default, the 560 Series headset and base initiates a DECT connection when there is a call or other audio playback from the phone. Always On mode maintains the DECT audio connection between your Cisco Headset 560 Series and the base.

By default, there is a bit delay at the beginning of a call when the headset establishes a connection with the base. Always On mode allows you to keep your audio connected between your headset and base even when you aren't on a call or playing music.



- Note**
- Your headset administrator can disable Always On mode through the call control system.
  - Always On mode impacts both DECT density deployment and headset battery life. Make sure to check with your administrator if you're using your headset in a dense DECT environment.
  - While Always On mode doesn't impact call quality, streaming audio quality does suffer slightly as the headset and base maintain a connection on a lower DECT frequency.
- 

## Before you begin

Check if you have the permission to set up the feature on the phone. If no, contact your administrator.

## Procedure

---

- Step 1** Press **Applications** .
- Step 2** Select **Accessories** and then your headset.
- Step 3** Navigate **Setup > Always On**.
- Step 4** Select **On** or **Off** to enable or disable the feature.

By default, the feature is disabled.

---

## Cisco Headset 700 Series Customization

### Set the Cisco Headset 730 Noise Cancellation Level

Your headset can filter out any background sounds with noise cancellation.

#### Procedure

---

- Step 1** Press **Applications** .
  - Step 2** Select **Accessories** and then your headset.
  - Step 3** Navigate **Setup > Audio > Noise cancellation**.
  - Step 4** Select the desired setting and press **Set**.
- 

### Set the Cisco Headset 730 Sidetone Level

Sidetone is the term for when you hear your own voice in your headset. Some people are distracted when they hear their own voice during a call, while other people want to know that their headset is working.

#### Procedure

---

- Step 1** Press **Applications** .
  - Step 2** Select **Accessories** and then your headset.
  - Step 3** Navigate **Setup > Audio > Sidetone**.
  - Step 4** Select the desired setting and press **Set**.
- 

### Set the Cisco Headset 730 Equalizer

You can customize the blend of bass and treble in your headset audio. Choose from a number of preset audio settings including **Voice**, **Music**, and **Cinema**.

#### Procedure

---

- Step 1** Press **Applications** .
  - Step 2** Select **Accessories** and then your headset.
  - Step 3** Navigate **Setup > Audio > Equalizer**.
  - Step 4** Select the desired setting and press **Set**.
-

## Set the Cisco Headset 730 Audio Notifications

You can customize which audio notifications you want to hear in your headset. By default, your headset plays audio notifications to alert you to events such as incoming calls, battery charge, and Bluetooth connection status. You can also change your audio notifications to any one of twelve languages.



**Note** When you change your audio notification language, your headset needs to download and install the relevant firmware file. Allow 7-10 minutes for the firmware change to complete.

### Procedure

- Step 1** Press **Applications** .
- Step 2** Select **Accessories** and then your headset.
- Step 3** Navigate **Setup > Audio > Audio Notifications**.
- Step 4** Select the desired setting and press **Set**.

## Set the Cisco Headset 730 General Settings

You can customize the settings on your Cisco Headset 730 through the menu on your Cisco IP Phone.

### Procedure

- Step 1** Press **Applications** .
- Step 2** Select **Accessories** and then your headset.
- Step 3** Select **Setup > General**.
- Step 4** Configure the settings.

Parameter	Choice	Description
Auto-mute	On, Off Default: On	When Auto-mute is enabled, you can take off your headset to mute your microphone on a call. Your headset automatically unmutes when you put your headset back on.
Auto-answer call	On, Off Default: On	When Auto-answer call is enabled, you can answer an incoming call when you put your headset on your head. You can also end a call when you take your headset off.
Auto-play/pause	On, Off Default: On	When Auto-play/pause is enabled, you can automatically pause and play music playback when you take off and put on your headset.

Parameter	Choice	Description
Sync DND status	On, Off Default: Off	When <b>Sync DND status</b> is enabled you can press <b>Mute</b>  to turn the Presence LED Lights on and off when you aren't on a call.

## Reset the Cisco Headset 730 Settings

You can reset the headset to the factory default settings.

### Procedure

- Step 1** Press **Applications** .
- Step 2** Select **Accessories** and then your headset.
- Step 3** Select **Setup** > **Reset Settings**.
- Step 4** Press **Reset** to confirm the operation.

## View the Cisco Headset 730 Details

You can view information about your headset.

### Procedure

- Step 1** Press **Applications** .
- Step 2** Select **Accessories** and then your headset.
- Step 3** Press **Show details**.

## Change your headset ringer settings

You can change your headset ringtone behavior on Cisco IP phones with phone firmware 14.0 or later. The setting is saved on the phone and will apply to any Cisco Headset 500 Series that connects.

### Procedure

- Step 1** Press **Applications** .
- Step 2** Select **Preferences** > **Headset ringer**.
- Step 3** Select a ringer setting.



By default, your phone follows the behavior of the phone ringer settings. Select **On** if you want to always hear the phone ring when you have an incoming call. If you select **Off**, you won't hear any ring through your headset when there is an incoming call.

- Step 4** Select **Set** to apply your settings.
- 

## Test Your Microphone

Check your microphone when you first install it, and before you begin a call.

### Procedure

---

- Step 1** Press **Applications** .
- Step 2** Select **Accessories** and then your headset.
- Step 3** Navigate to **Setup > Microphone > Test**.
- Step 4** Press **Record** and speak into the microphone.
- Step 5** Press **Stop rec** when you finish speaking.
- Step 6** Press **Play** to review your test recording.
- 

## Update your Cisco headset firmware with a Cisco IP phone

You can update your headset software on any supported Cisco IP phone. During a headset firmware upgrade, you can view the progress on your phone screen.

During the update, the LEDs on the Cisco Headset 560 Series base blink in sequence from left to right. After the software upgrade completes successfully, the LEDs return to their idle state.

### Procedure

---

- Step 1** Connect your headset to a Cisco IP phone.
- Note** You can only upgrade the Cisco Headset 730 on IP phones through the USB cable.
- Step 2** If the headset does not automatically begin to update, restart the phone. The phone downloads the latest headset version file when the phone restarts and uploads it to the headset.
- 

## Swap Headsets While on a Call

When you connect multiple headsets to the phone, you can switch among the headsets during a call by pressing the **Headset** key on the phone. Though the phone is connected to multiple devices, you see a specific headset is selected as the preferred audio device in the following priority order:

- When you connect only an analog headset to the phone, you make your analog headset the preferred audio device.

### Procedure

---

- Step 1** Before you make or answer a call, press **Headset**.
- Step 2** (Optional) If you place a call, dial the number.
- 

## Troubleshoot Your Cisco Headset

Try the following basic troubleshooting steps if you have trouble with your Cisco headset.

- Restart your headset.
- Make sure that all cords are properly plugged in and functioning properly.
- Test a different headset with your device to determine if the problem is with your wireless headset or your device.
- Make sure that your phone firmware is the latest release.

## Confirm that Your Headset Is Registered

### Procedure

---

Check to see if your headset is registered with the phone.

- Step 1** Press **Applications** .
- Step 2** Navigate to **Accessories**. Select **Show detail**.
- 

## No Sound in Headset

### Problem

There is little or no sound coming through the headset.

### Solution

Check the volume level on your headset by pressing the volume controls to adjust the sound level. If the problem continues, use the following work flow to troubleshoot your problem.

Figure 23: No Audio Workflow

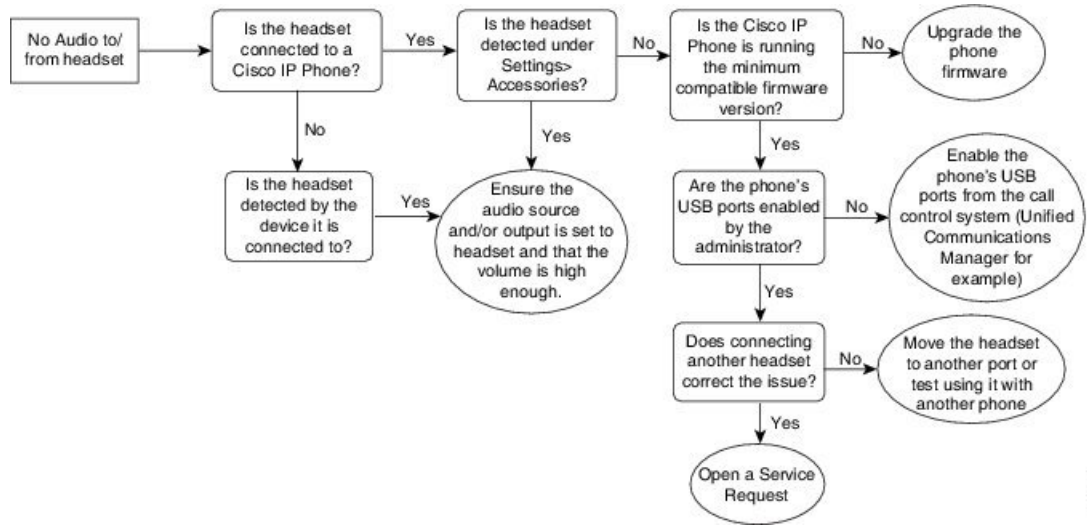

38138137

## Poor Audio

### Problem

Your headset is functioning, but the audio quality is poor.

### Solution

Use the following work flow to troubleshoot your problem.

Figure 24: Poor Audio

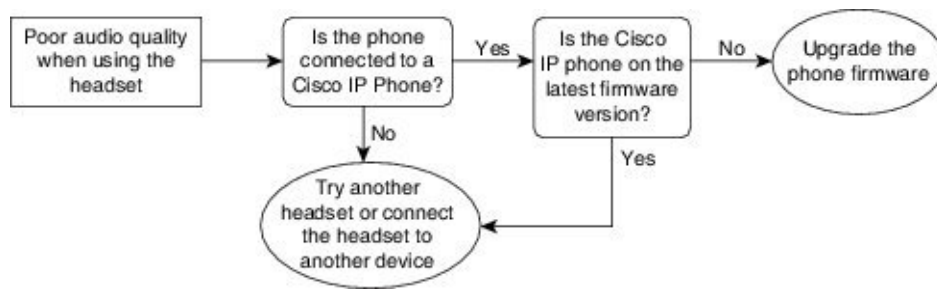

38138138

## Microphone Not Picking up Sound

### Problem

You cannot be heard when using your headset.

### Solutions

- Check to make sure your microphone is not muted. Press the mute button on your headset to mute and unmute your microphone.

- Make sure that the microphone boom has been lowered. For optimal sound, keep the headset microphone no further than 1 in or 2.5 cm from your face.
- Make sure that your headset is properly plugged into your device.
- For the Cisco Headset 560 Series, check that you are not taking your headset too far from the headset base. The headset has an effective range of approximately 100 feet or 30 meters.

## Headset Not Charging

### Problem

Your Cisco Headset 561 and 562 is not charging when placed on the base.

### Solution

- Check that your base is plugged into a reliable power source.
- Make sure that your headset is properly seated on the base. When the headset is properly seated, the LED shows solid white. When charging, the LEDs on the base light up in sequence from left to right. When the headset is fully charged, all five battery indicator LEDs show solid white.

**Figure 25: Cisco Headset 561 and 562 Headset Placement**

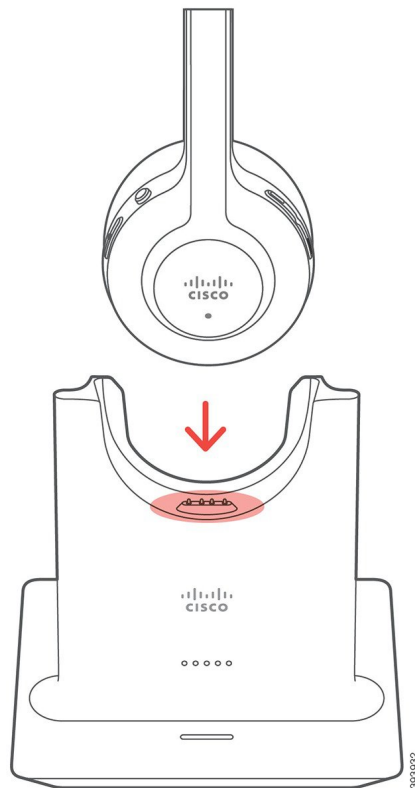

## Headset Battery Not Holding a Charge

### Problem

The wireless headset is not holding a full charge.

### Solution

Your Cisco Headset 561 and 562 holds a charge for up to 8 hours of continuous use. If your headset battery seems weak or defective, contact Cisco support.

## Cisco IP Phone 8800 Key Expansion Module

A key expansion module allows you to add extra line appearances or programmable buttons to your phone. The programmable buttons can be set up as phone line buttons, speed-dial buttons, or phone feature buttons.

Simplified dialing is not supported on the expansion modules.

There are 3 expansion modules available:

- Cisco IP Phone 8800 Key Expansion Module—Single LCD screen module, 18 line keys, 2 pages, configure with one or two column displays.
- Cisco IP Phone 8851/8861 Key Expansion Module—Dual LCD screen module for audio phones, 14 line keys, 2 pages, configure with one-column display only. If you are in Enhanced line mode, and you receive a call on a key expansion line, then a Call Alert displays on the phone, and the Caller ID displays on the expansion module line.
- Cisco IP Phone 8865 Key Expansion Module—Dual LCD screen module for video phones, 14 line keys, 2 pages, configure with one-column display only. If you are in Enhanced line mode, and you receive a call on a key expansion line, then a Call Alert displays on the phone, and the Caller ID displays on the expansion module line.

Cisco IP Phone 8851/8861 Key Expansion Module require firmware release 12.0(1) or later, and Cisco Unified Communications Manager 10.5(2) or later to function. Enhanced line mode (ELM) is supported only on the Cisco IP Phone 8851/8861 Key Expansion Module and the Cisco IP Phone 8865 Key Expansion Module. ELM is not supported on the single LCD expansion modules.

If you are using more than one expansion module, all the modules must be the same type. You cannot combine different expansion modules on your phone.

When you configure your wallpaper on your Cisco IP Phone 8800 Series device, it also displays on your dual LCD key expansion modules. It is not supported on the single LCD expansion modules. Custom background images may not be supported.

The following table describes the number of Key Expansion Modules supported by each model in the Cisco IP Phone 8800 Series.

**Table 35: Key Expansion Module Support**

Cisco IP Phone Model	Supported Single LCD Key Expansion Modules	Supported Dual LCD Key Expansion Modules
Cisco IP Phone 8851 and 8851NR	2; providing 72 lines or buttons	2; providing 56 lines or buttons
Cisco IP Phone 8861	3; providing 108 lines or buttons	3; providing 84 lines or buttons
Cisco IP Phone 8865 and 8865NR	3; providing 108 lines or buttons	3; providing 84 lines or buttons

When multiple key expansion modules are attached to the phone, they are numbered according to the order in which they are connected to the phone. For example:

- Key expansion module 1 is the closest unit to the phone.
- Key expansion module 2 is the unit in the middle.
- Key expansion module 3 is the farthest unit from the phone.

**Figure 26: Cisco IP Phone 8861 with Three Cisco IP Phone 8800 Key Expansion Modules**



3941036

Figure 27: Cisco IP Phone 8865 with Three Cisco IP Phone 8865 Key Expansion Modules



**Caution** The slots in the side of the phone are designed only for use with the spine connectors on the key expansion module. Insertion of other objects permanently damages the phone.

When you use key expansion modules, check with your administrator about power requirements.





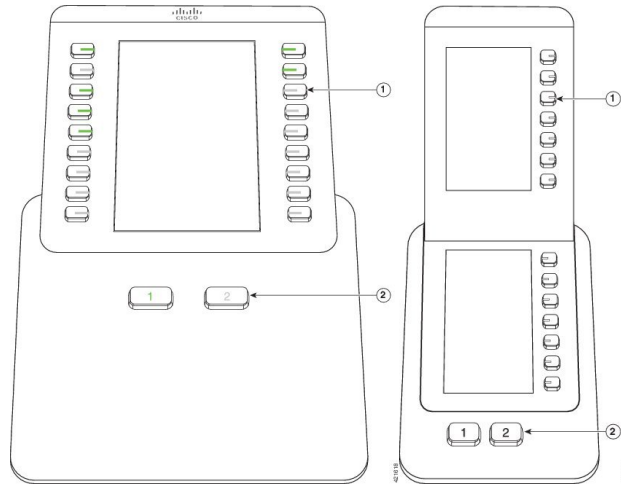

## Key Expansion Module Buttons and Hardware

Figure 28: Cisco IP Phone Key Expansion Module Buttons and Hardware



The following table describes the features of the key expansion module.

**Table 36: Key Expansion Modules Buttons and Hardware**

	<p>LCD screen—Displays the phone number, speed-dial number (or name or other text label), phone service, or phone feature assigned to each button.</p> <p>Icons that indicate line status resemble (in both appearance and function) the icons on the phone to which the key expansion module is attached.</p>
1	<p>Lighted buttons—18 line buttons. Depending on the mode, each button or pair of buttons corresponds to one line (same as on the phone). For mode information, see the descriptions of 1-column and 2-column mode that follow this table. The lights beneath each button indicate the state of the corresponding line as follows:</p> <ul style="list-style-type: none"> <li>•  light off—Line available or a call is ringing on an inactive page.</li> <li>•  green steady LED—Line in use by you, you have a call on hold, or a call being transferred.</li> <li>•  red steady LED—Line in use by someone else or someone else has a call on hold on a shared line.</li> <li>•  amber steady LED—Line ringing.</li> </ul>
2	<p>Shift buttons—2 buttons. The button for page 1 is labeled as <b>1</b> and the button for page 2 is labeled as <b>2</b>. The lights in each button indicate the state of the page as follows:</p> <ul style="list-style-type: none"> <li>•  green steady LED—Page is in view.</li> <li>•  light off—Page is not in view.</li> <li>•  amber steady LED—Page is not in view with one or more alerting calls on the page.</li> </ul>

Your administrator sets up the key expansion module to display in one-column or two-column mode.

### One-Column Mode

In one-column mode, each row in the display corresponds to one line. You can access this line by either the button on the left or the button on the right. In this configuration, the key expansion module displays nine lines on page 1, and nine lines on page 2.



**Figure 29: Key Expansion Module with One Column**



### Two-Column Mode

If you are using a single-LCD screen expansion module, you can set up the module in two-column mode.

In two-column mode, each button on the left and right of the screen is assigned to a different phone number, speed-dial number (or name or other text label), phone service, or phone feature. In this configuration, the key expansion module displays up to 18 items on page 1, and up to 18 items on page 2

**Figure 30: Key Expansion Module with Two Columns**



## Place a Call on the Key Expansion Module

### Procedure

- 
- Step 1** Press the line button on the key expansion module.
  - Step 2** Dial a phone number.
  - Step 3** Pick up your handset.
- 

## Adjust the Key Expansion Module Screen Brightness

### Procedure

- 
- Step 1** Press **Applications** .
  - Step 2** Select **Settings** > **Brightness** > **Brightness - Key expansion module x**, where x is the number of the key expansion module.
  - Step 3** Press right on the Navigation pad to increase brightness. Press left on the Navigation pad to decrease brightness.
  - Step 4** Press **Save**.
- 

## Silicone Covers

You can use the Cisco IP Phone Silicone Cover to protect your desk phone and handset.

The case offers the following benefits:

- Hypoallergenic
- Resistant to wear from a variety of cleaning agents.



---

**Note** Use a low-strength cleaning agent to prolong the life and look of the case.

---

- Reduces damage when the handset is dropped.

For part numbers and other additional information, refer to the phone model data sheet. The Cisco IP Phone 8800 Series data sheets can be found here <https://www.cisco.com/c/en/us/products/collaboration-endpoints/unified-ip-phone-8800-series/datasheet-listing.html>. The Cisco IP Phone 7800 Series data sheets can be found here <https://www.cisco.com/c/en/us/products/collaboration-endpoints/unified-ip-phone-7800-series/datasheet-listing.html>.

To check which phone model you have, press **Applications**  and select **Phone information**. The **Model number** field shows your phone model.

Table 37: Silicone Covers

Cisco IP Phone	Cisco IP Phone Silicone Cover	Notes
Cisco IP Phone 7821	<ul style="list-style-type: none"> <li>• 10 pack of Silicone Covers for 7821 Desktop Phone Series (CP-7821-COVER=)</li> <li>• 10 pack of Silicone Covers for 7821 Desktop Phone Series and Handset (CP-7821-COVER-BUN=)</li> </ul>	
Cisco IP Phone 7841	<ul style="list-style-type: none"> <li>• 10 pack of Silicone Covers for 7841 Desktop Phone Series (CP-7841-COVER=)</li> <li>• 10 pack of Silicone Covers for 7841 Desktop Phone Series and Handset (CP-7841-COVER-BUN=)</li> </ul>	
Cisco IP Phone 8811, 8841, 8851, 8851NR, 8861, and 8861NR	<ul style="list-style-type: none"> <li>• 10 pack of Silicone Covers for 88X1 Desktop Phone Series (CP-88X1-COVER=)</li> <li>• 10 pack of Silicone Covers for 88X1 Desktop Phone Series and Handset (CP-88X1-COVER-BUN=)</li> </ul>	<b>Note</b> The silicone cover doesn't protect the Key Expansion Module.
Cisco IP Phone 8845, 8865, and 8865NR	<ul style="list-style-type: none"> <li>• 10 pack of Silicone Covers for 88X5 Desktop Phone Series (CP-88X5-COVER=)</li> <li>• 10 pack of Silicone Covers for 88X5 Desktop Phone Series and Handset (CP-88X5-COVER-BUN=)</li> </ul>	<b>Note</b> The silicone cover doesn't protect the Key Expansion Module.
Cisco IP Phone Handset	<ul style="list-style-type: none"> <li>• 10 pack of Silicone Covers for Desktop Phone Handsets (CP-HS-COVER=)</li> </ul>	

## Install the Cisco IP Phone Silicone Cover

The silicone cover helps prolong the life of your Cisco IP Phone and make it easier to keep the buttons and number pad clean.

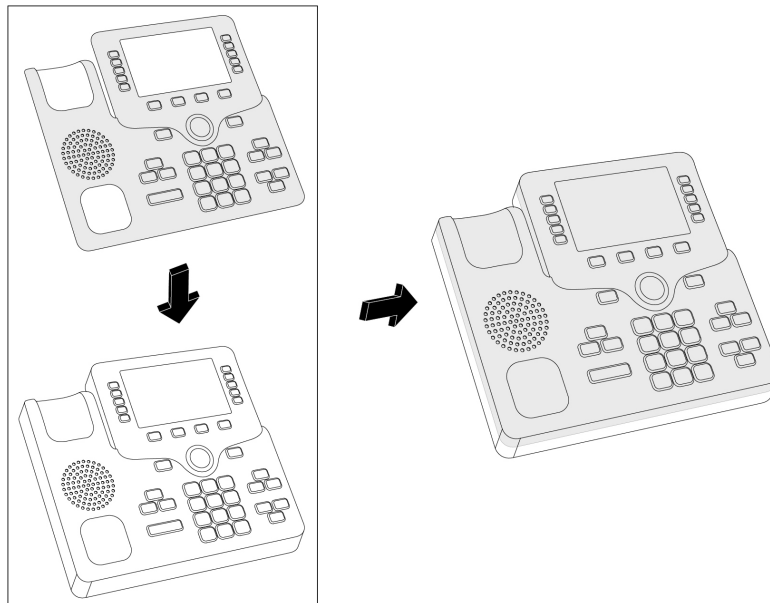

455568

### Procedure

- 
- Step 1** Position the phone facing you.
  - Step 2** Remove the handset from the cradle.
  - Step 3** Align the cover over the phone with the handset on the left.
  - Step 4** Secure the cover around the corners and side of the phone. The cover should fit securely over the phone without much resistance.
  - Step 5** Place the handset back on the cradle.
- 

## Install the Cisco IP Phone Handset Cover

A silicone cover helps to protect your handset from damage and reduces the spread of germs.

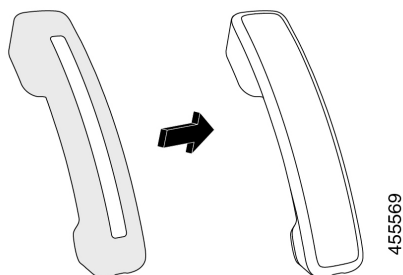

455569

### Procedure

---

- Step 1** Remove the handset from the phone cradle.
- Step 2** Disconnect the cable from the handset.
- Step 3** Slide the silicone cover over the handset until the ear cup is completely inside the cover.
- Step 4** Pull the cover over the other end of the handset.

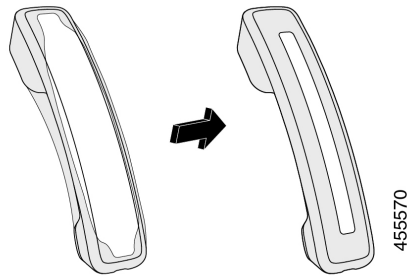

- Step 5** Make sure the cover is flush against the handset and that the cable port is unobstructed.
- Step 6** Reconnect the handset to the phone and return it to the cradle.
- 

## Clean the Silicone Cover

Clean your cover if you are worried about dirt and grime. A regular cleaning also prevents the spread of bacteria or germs.

### Procedure

---

- Step 1** Remove the silicone cover.
- Step 2** Clean the cover.
- Note** Use a low-strength cleaning agent to prolong the life and look of the case.
- Step 3** Dry the cover thoroughly. Don't put it back on the phone until it is completely dry.
- Step 4** Put the cover back on the phone.
-





## CHAPTER 8

# Product Safety and Security

---

- [Safety and Performance Information, on page 153](#)
- [Compliance Statements, on page 155](#)
- [Cisco Product Security Overview, on page 160](#)
- [Cisco Circular Economy, on page 160](#)
- [Important Online Information, on page 161](#)

## Safety and Performance Information

### Power Outage

Your access to emergency service through the phone requires that the phone receive power. If a power interruption occurs, service or emergency calling service dialing does not function until power is restored. If a power failure or disruption occurs, you may need to reset or reconfigure the equipment before you can use service or emergency calling service dialing.

### Regulatory Domains

The radio frequency (RF) for this phone is configured for a specific regulatory domain. If you use this phone outside of the specific regulatory domain, the phone will not function properly, and you might violate local regulations.

### Health-Care Environments

This product is not a medical device and uses an unlicensed frequency band that is susceptible to interference from other devices or equipment.

### External Devices

We recommend that you use good-quality external devices that are shielded against unwanted radio frequency (RF) and audio frequency (AF) signals. External devices include headsets, cables, and connectors.

Depending on the quality of these devices and their proximity to other devices, such as mobile phones or two-way radios, some audio noise may still occur. In these cases, we recommend that you take one or more of these actions:

- Move the external device away from the source of the RF or AF signals.
- Route the external device cables away from the source of the RF or AF signals.
- Use shielded cables for the external device, or use cables with a better shield and connector.
- Shorten the length of the external device cable.
- Apply ferrites or other such devices on the cables for the external device.

Cisco cannot guarantee the performance of external devices, cables, and connectors.



---

**Caution** In European Union countries, use only external speakers, microphones, and headsets that are fully compliant with the EMC Directive [89/336/EC].

---

## Bluetooth Wireless Headset Performance

Cisco IP Phones support Bluetooth Class 2 technology when the headsets support Bluetooth. Bluetooth enables low-bandwidth wireless connections within a range of 30 feet (10 meters). The best performance is in the 3- to 6-foot (1- to 2-meter) range. You can connect up to five headsets, but only the last one connected is used as the default.

Because of potential interference issues, we recommend that you move 802.11b/g devices, Bluetooth devices, microwave ovens, and large metal objects away from the wireless headset.

The Bluetooth wireless headset does not need to be within direct line-of-sight of the phone. However, some barriers, such as walls or doors, and interference from other electronic devices, can affect the connection.

## Ways to Provide Power to Your Phone

You can provide power to your phone in one of these ways:

- Use the power adapter that comes with your phone.
- If your network supports Power over Ethernet (PoE), you can plug your phone into the network. Plug an Ethernet cable into the Ethernet phone port  and into the network.

If you are not sure whether your network supports PoE, check with your administrator.

## Phone Behavior During Times of Network Congestion

Anything that degrades network performance can affect phone audio and video quality, and in some cases, can cause a call to drop. Sources of network degradation can include, but are not limited to, the following activities:

- Administrative tasks, such as an internal port scan or security scan.
- Attacks that occur on your network, such as a Denial of Service attack.



## UL Warning

The LAN/Ethernet cable or other cables attached to the device should not be extended outside of the building.

## EnergyStar



The following phones have EnergyStar certification:

- Cisco IP Phone 8811
- Cisco IP Phone 8841
- Cisco IP Phone 8851
- Cisco IP Phone 8851NR

Any phone model that isn't listed in the above list isn't certified.

## Product Label

The product label is located on the bottom of the device.

## Compliance Statements

### Compliance Statements for the European Union

#### CE Marking

The following CE mark is affixed to the equipment and packaging.



## RF Exposure Statement for the European Union

This device has been evaluated and found compliant in accordance with EU EMF Directive 2014/53/EU.

## Compliance Statements for the USA

### Part 15 Radio Device



---

**Caution** The Part 15 radio device operates on a non-interference basis with other devices operating at this frequency. Any changes or modification to said product not expressly approved by Cisco, including the use of non-Cisco antennas, could void the user's authority to operate this device.

---

## Compliance Statements for Canada

This device complies with Industry Canada license-exempt RSS standard(s). Operation is subject to the following two conditions: (1) this device may not cause interference, and (2) this device must accept any interference, including interference that may cause undesired operation of the device. Privacy of communications may not be ensured when using this phone.

This product meets the applicable Innovation, Science and Economic Development Canada technical specifications.

### Avis de Conformité Canadien

Cet appareil est conforme aux normes RSS exemptes de licence RSS d'Industry Canada. Le fonctionnement de cet appareil est soumis à deux conditions : (1) ce périphérique ne doit pas causer d'interférence et (2) ce périphérique doit supporter les interférences, y compris celles susceptibles d'entraîner un fonctionnement non souhaitable de l'appareil. La protection des communications ne peut pas être assurée lors de l'utilisation de ce téléphone.

Le présent produit est conforme aux spécifications techniques applicables d'Innovation, Sciences et Développement économique Canada.

## Canadian RF Exposure Statement

### THIS DEVICE MEETS THE LIMITS AS REFERENCED BY ISED RSS-102 R5 FOR EXPOSURE TO RADIO WAVES

Your device includes a radio transmitter and receiver. It is designed not to exceed the General populace (uncontrolled) limits for exposure to radio waves (radio frequency electromagnetic fields) as referenced in RSS-102 which references Health Canada Safety Code 6 and include a substantial safety margin designed to assure the safety of all persons, regardless of age and health.

As such the systems are designed to be operated as to avoid contact with the antennas by the end user. It is recommended to set the system in a location where the antennas can remain at least a minimum distance as specified from the user in accordance to the regulatory guidelines which are designed to reduce the overall exposure of the user or operator.

The device has been tested and found compliant with the applicable regulations as part of the radio certification process.

### **Déclaration d'Exposition aux RF Canadienne**

#### CE PÉRIPHÉRIQUE RESPECTE LES LIMITES DÉCRITES PAR LA NORME RSS-102 R5 D'EXPOSITION À DES ONDES RADIO

Votre appareil comprend un émetteur et un récepteur radio. Il est conçu pour ne pas dépasser les limites applicables à la population générale (ne faisant pas l'objet de contrôles périodiques) d'exposition à des ondes radio (champs électromagnétiques de fréquences radio) comme indiqué dans la norme RSS-102 qui sert de référence au règlement de sécurité n°6 sur l'état de santé du Canada et inclut une marge de sécurité importantes conçue pour garantir la sécurité de toutes les personnes, quels que soient leur âge et état de santé.

En tant que tels, les systèmes sont conçus pour être utilisés en évitant le contact avec les antennes par l'utilisateur final. Il est recommandé de positionner le système à un endroit où les antennes peuvent demeurer à au moins une distance minimum préconisée de l'utilisateur, conformément aux instructions des réglementations qui sont conçues pour réduire l'exposition globale de l'utilisateur ou de l'opérateur.

Le périphérique a été testé et déclaré conforme aux réglementations applicables dans le cadre du processus de certification radio.

### **Canadian High-Power Radars Statement**

Users should also be advised that high-power radars are allocated as primary users (that is, priority users) of the bands 5250-5350 MHz and 5650-5850 MHz and that these radars could cause interference and/or damage to LE-LAN devices.

Devraient également être informés des utilisateurs que les radars à haute puissance sont désignés comme utilisateurs principaux (à savoir des utilisateurs prioritaires) des bandes 5250-5350 MHz et 5650 à 5.850 MHz et que ces radars pourraient provoquer des interférences et / ou endommager les périphériques LE-LAN.

## **Compliance Statements for New Zealand**

### **Permit to Connect (PTC) General Warning**

The grant of a Telepermit for any item of terminal equipment indicates only that Spark NZ has accepted that the item complies with minimum conditions for connection to its network. It indicates no endorsement of the product by Spark NZ, nor does it provide any sort of warranty. Above all, it provides no assurance that any item will work correctly in all respects with another item of Telepermitted equipment of a different make or model, nor does it imply that any product is compatible with all of Spark NZ network services.

## Compliance Statements for Taiwan

### DGT Warning Statement

#### Low Power and Visual Warning Notices

視力保護警語：使用過度恐傷害視力

低功率射頻電機警語：

經型式認證合格之低功率射頻電機，非經許可，公司、商號或使用者均不得擅自變更頻率、加大功率或變更原設計之特性之功能。

低功率射頻電機之使用不得影響飛航安全及干擾合法通信；經發現有干擾現象時，應立即停用，並改善至無干擾時方得繼續使用。前項合法通信，指依電信法規定作業之無線電通信。低功率射頻電機須忍受合法通信或工業、科學及醫療用電波輻射性電機設備之干擾。

4.7.9.1 應避免影響附近雷達系統之操作。

4.7.9.2 高增益指向性天線只得應用於固定式點對點系統。

## Compliance Statement for Argentina

### Advertencia

No utilizar una fuente de alimentación con características distintas a las expresadas ya que podría ser peligroso.

## Compliance Information for Brazil

### Art. 5º - 680

This equipment is not entitled to protection against harmful interference and can't cause interference in proper authorized systems.

For more information, go to this URL: <http://www.anatel.gov.br>

Model	Certificate Number
8811	3965-14-1086
8841	3965-14-1086
8845	4243-15-9863
8851	3965-14-1086
8851NR	3965-14-1086
8861	0463-15-1086
8865	06125-16-01086
8865NR	06125-16-01086

## Compliance Statement for Singapore

**Complies with  
IMDA Standards  
DB101992**

## Compliance Information for Japan



VCCI Compliance for Class B Equipment

## FCC Compliance Statements

The Federal Communications Commission requires compliance statements for the following statements.

### FCC Part 15.19 Statement

This device complies with part 15 of the FCC Rules. Operation is subject to the following two conditions: (1) This device may not cause harmful interference, and (2) this device must accept any interference received, including interference that may cause undesired operation.

### FCC Part 15.21 Statement

Changes or modifications not expressly approved by the party responsible for compliance could void the user's authority to operate the equipment.

### FCC RF Radiation Exposure Statement

This equipment complies with FCC radiation exposure limits set forth for an uncontrolled environment. End users must follow the specific operating instructions for satisfying RF exposure compliance. This transmitter must be at least 20 cm from the user and must not be collocated or operating in conjunction with any other antenna or transmitter.

### FCC Receivers and Class B Digital Statement

This product has been tested and complies with the specifications for a Class B digital device, pursuant to Part 15 of the FCC Rules. These limits are designed to provide reasonable protection against harmful interference in a residential installation. This equipment generates, uses, and can radiate radio frequency energy and, if not installed and used according to the instructions, may cause harmful interference to radio communications. However, there is no guarantee that interference will not occur in a particular installation.

If this equipment does cause harmful interference to radio or television reception, which is found by turning the equipment off and on, the user is encouraged to try to correct the interference by one or more of the following measures:

- Reorient or relocate the receiving antenna
- Increase the separation between the equipment or devices
- Connect the equipment to an outlet other than the receiver's
- Consult a dealer or an experienced radio/TV technician for assistance

## Cisco Product Security Overview

This product contains cryptographic features and is subject to U.S. and local country laws that govern import, export, transfer, and use. Delivery of Cisco cryptographic products does not imply third-party authority to import, export, distribute, or use encryption. Importers, exporters, distributors, and users are responsible for compliance with U.S. and local country laws. By using this product, you agree to comply with applicable laws and regulations. If you are unable to comply with U.S. and local laws, return this product immediately.

Further information regarding U.S. export regulations can be found at <https://www.bis.doc.gov/policiesandregulations/ear/index.htm>.

## Cisco Circular Economy

Cisco has adopted circular design principles in its products by pioneering the use of post-consumer recycled plastic. The models listed below now reduce the use of natural resources while closing the loop with its own electronic waste.

- Cisco IP Phone 8811
- Cisco IP Phone 8841
- Cisco IP Phone 8851 and Cisco IP Phone 8851NR
- Cisco IP Phone 8861

Visit Cisco's Circular Economy website to learn more about what this means:

- Web site URL: <https://www.cisco.com/c/en/us/about/circular-economy.html>



- Web site QR code:



## Important Online Information

### End User License Agreement

The End User License Agreement (EULA) is located here: <https://www.cisco.com/go/eula>

### Regulatory Compliance and Safety Information

Regulatory Compliance and Safety Information (RCSI) is located here:

[https://www.cisco.com/c/dam/en/us/td/docs/voice\\_ip\\_comm/cuipph/8800-series/regulatory\\_compliance/RCSI-0313-book.pdf](https://www.cisco.com/c/dam/en/us/td/docs/voice_ip_comm/cuipph/8800-series/regulatory_compliance/RCSI-0313-book.pdf)

