

DS4678

Digital Scanner



ZEBRA

Product Reference Guide

2024/06/10

ZEBRA and the stylized Zebra head are trademarks of Zebra Technologies Corporation, registered in many jurisdictions worldwide. All other trademarks are the property of their respective owners. ©2024 Zebra Technologies Corporation and/or its affiliates. All rights reserved.

Information in this document is subject to change without notice. The software described in this document is furnished under a license agreement or nondisclosure agreement. The software may be used or copied only in accordance with the terms of those agreements.

For further information regarding legal and proprietary statements, please go to:

SOFTWARE: zebra.com/informationpolicy.

COPYRIGHTS: zebra.com/copyright.

PATENTS: ip.zebra.com.

WARRANTY: zebra.com/warranty.

END USER LICENSE AGREEMENT: zebra.com/eula.

Terms of Use

Proprietary Statement

This manual contains proprietary information of Zebra Technologies Corporation and its subsidiaries ("Zebra Technologies"). It is intended solely for the information and use of parties operating and maintaining the equipment described herein. Such proprietary information may not be used, reproduced, or disclosed to any other parties for any other purpose without the express, written permission of Zebra Technologies.

Product Improvements

Continuous improvement of products is a policy of Zebra Technologies. All specifications and designs are subject to change without notice.

Liability Disclaimer

Zebra Technologies takes steps to ensure that its published Engineering specifications and manuals are correct; however, errors do occur. Zebra Technologies reserves the right to correct any such errors and disclaims liability resulting therefrom.

Limitation of Liability

In no event shall Zebra Technologies or anyone else involved in the creation, production, or delivery of the accompanying product (including hardware and software) be liable for any damages whatsoever (including, without limitation, consequential damages including loss of business profits, business interruption, or loss of business information) arising out of the use of, the results of use of, or inability to use such product, even if Zebra Technologies has been advised of the possibility of such damages. Some jurisdictions do not allow the exclusion or limitation of incidental or consequential damages, so the above limitation or exclusion may not apply to you.

Contents

Introduction.....	23
Configurations.....	23
Notational Conventions.....	25
Icon Conventions.....	25
Service Information.....	25
Getting Started.....	27
Interfaces.....	27
Unpacking.....	27
Features.....	28
Cradle Features.....	29
Standard Cradle.....	29
Presentation Cradle.....	31
Connecting the Cradle.....	31
Changing the Host Interface.....	32
DC Power Supply.....	32
Mounting the Cradle.....	33
Battery.....	33
Charging the DS4678 Battery.....	34
Shutting Off the Battery.....	34
Replacing the Battery.....	35
Inserting the Scanner into the CR8178-SC Cradle.....	36
Inserting the Scanner into the CR8178-PC Cradle.....	37
Host Computer Communication.....	37
Pairing.....	38

Reconnecting to the Host.....	38
Data Capture.....	39
Scanner Indications.....	39
Cradle LED Indications.....	42
Hands-Free Scanning.....	43
Hand-Held Scanning.....	43
Aiming.....	44
Decode Ranges.....	45
123Scan and Software Tools.....	47
123Scan.....	47
Communication with 123Scan.....	48
123Scan Requirements.....	48
123Scan Information.....	48
Scanner SDK, Other Software Tools, and Videos.....	49
Scanner Control App.....	49
Scan-To-Connect Utility.....	50
Maintenance, Troubleshooting, and Specifications.....	51
Maintenance.....	51
Known Harmful Ingredients.....	51
Cleaning the Scanner.....	52
Troubleshooting.....	52
Dumping Scanner Parameters.....	56
Send Versions.....	56
Send Software Version.....	56
Send Serial Number.....	56
Send Manufacturing Information.....	57
Technical Specifications.....	57
Cradle Signal Descriptions.....	57
Radio Communications.....	59

Setting Radio Parameters.....	59
Radio Communications Parameter Defaults.....	59
Wireless Beeper Definitions.....	62
Radio Communications Host Types.....	62
Cradle.....	62
Keyboard Emulation (HID).....	63
Simple Serial Interface (SSI).....	63
Serial Port Profile (SPP).....	64
Bluetooth Technology Profile Support.....	65
Central/Peripheral Modes.....	65
Bluetooth Friendly Name.....	66
Discoverable Mode.....	66
Wi-Fi Friendly Options.....	67
Wi-Fi Friendly Mode.....	67
Wi-Fi Friendly Channel Exclusion.....	67
Bluetooth Radio Parameters.....	69
Radio Output Power.....	69
Link Supervision Timeout.....	69
Bluetooth Radio State.....	70
HID Host Parameters.....	71
Apple iOS Virtual Keyboard Toggle.....	71
Keyboard Keystroke Delay.....	71
Caps Lock Override (Radio).....	71
Barcodes with Unknown Characters (Radio).....	72
Fast HID Keyboard.....	72
Numeric Keypad Emulation.....	72
Quick Keypad Emulation (Radio).....	73
Keyboard FN1 Substitution.....	73
Function Key Mapping (Radio).....	73
Simulated Caps Lock (Radio).....	74
Convert Case (Radio).....	74
Auto-reconnect Parameters.....	75
Beep on Reconnect Attempt.....	75
Reconnect Attempt Interval.....	76

Auto-reconnect.....	76
Sleep Between Attempts.....	77
Number of Retry Attempts.....	78
Scanner(s) to Cradle Support.....	79
Modes of Operation.....	79
Parameter Broadcast (Cradle Host Only).....	79
Pairing.....	80
Pair on Contacts.....	81
Pull Trigger Twice to Re-connect.....	81
Unpairing.....	82
Toggle Pairing.....	82
Pairing Barcode Format Using the Scan-To-Connect (STC) Utility.....	82
Connection Maintenance Interval.....	82
Page Parameters.....	84
Page Button.....	84
Page Mode.....	84
Page State Timeout.....	85
Bluetooth Security.....	85
PIN Code.....	85
Variable PIN Code.....	86
Bluetooth Security Level.....	87
Virtual Tether.....	88
Configure the Alarm on the Scanner.....	88
Virtual Tether Alarm on the Cradle.....	90
Delay Before Virtual Alarm Activates.....	91
Virtual Tether Alarm Duration.....	91
Defeat Virtual Tether Alarm.....	91
Pause Virtual Tether Alarm Duration.....	92
Virtual Tether Alarm Considerations.....	93
General Radio Parameters.....	93
Batch Mode.....	93
Beep on Insertion.....	95
Bluetooth SPP Beep on <BEL>.....	96
Bluetooth Radio, Linking, and Batch Operation.....	96

Linking the Scanner to an iOS or Android Device.....	96
User Preferences and Miscellaneous Options.....	98
Setting User Preference Parameters.....	98
User Preference Scanning Sequence Examples.....	98
User Preference Errors While Scanning.....	98
User Preferences/Miscellaneous Options Parameter Defaults.....	98
User Preferences.....	101
Default Parameters.....	101
Parameter Barcode Scanning.....	102
Beep After Good Decode.....	102
Beeper Volume.....	102
Beeper Tone.....	103
Beeper Duration.....	104
Suppress Power Up Beeps.....	104
LED on Good Decode.....	104
Direct Decode Indicator.....	105
Decode Pager Motor.....	105
Decode Pager Motor Duration.....	106
Night Mode.....	107
Battery Preservation Mode.....	111
Battery Threshold.....	111
Time Delay to Low Power Mode.....	112
Timeout to Low Power Mode from Auto Aim.....	113
Hand-Held Trigger Mode.....	113
Hand-held Decode Aiming Pattern.....	114
Hands-free (Presentation) Decode Aiming Pattern.....	115
Hands-free Mode.....	115
Picklist Mode.....	116
Continuous Barcode Read.....	116
Unique Barcode Reporting.....	117
Decode Session Timeout.....	117
Hands-Free Decode Session Timeout.....	117
Timeout Between Decodes, Same Symbol.....	118

Timeout Between Decodes, Different Symbols.....	119
Triggered Timeout, Same Symbol.....	119
Mobile Phone/Display Mode.....	119
PDF Prioritization.....	120
PDF Prioritization Timeout.....	121
Presentation Mode Field of View.....	121
Decoding Illumination.....	121
Illumination Brightness Hand-Held.....	122
Motion Tolerance.....	122
Product ID (PID) Type.....	123
Product ID (PID) Value.....	123
ECLevel.....	124
DPM Parameters.....	124
DPM Illumination Control.....	124
DPM Mode.....	125
Miscellaneous Scanner Parameters.....	125
Enter Key.....	125
Tab Key.....	126
Transmit Code ID Character.....	126
Prefix Suffix Values.....	126
Scan Data Transmission Format.....	127
FN1 Substitution Values.....	128
Transmit No Read Message.....	129
Unsolicited Heartbeat Interval.....	129
securPharm Decoding.....	130
securPharm Output Formatting.....	131
Battery Charging User Indication Enhancement.....	134
Image Capture Preferences.....	135
Setting Image Capture Parameters.....	135
Image Capture Scanning Sequence Examples.....	135
Image Capture Errors While Scanning.....	135
Image Capture Preferences Parameter Defaults.....	136
Image Capture Preferences Modes and Parameters.....	137

Operational Modes.....	137
Image Capture Illumination.....	138
Image Capture Autoexposure.....	138
Fixed Exposure.....	139
Analog Gain.....	139
Digital Gain.....	139
Snapshot Mode Timeout.....	140
Snapshot Aiming Pattern.....	140
Silence Operational Mode Changes.....	141
Image Cropping.....	141
Crop to Pixel Addresses.....	142
Image Size (Number of Pixels).....	142
Image Brightness (Target White).....	143
JPEG Image Options.....	144
JPEG Quality Value.....	144
JPEG Size Value.....	144
Image Enhancement.....	145
Image File Format Selector.....	145
Image Rotation.....	146
Bits Per Pixel.....	146
Signature Capture.....	147
Signature Capture File Format Selector.....	148
Signature Capture Bits Per Pixel.....	148
Signature Capture Width.....	149
Signature Capture Height.....	149
Signature Capture JPEG Quality.....	150
USB Interface.....	151
USB Interface Connection.....	151
Connecting a USB Interface.....	152
USB Parameter Defaults.....	152
USB Host Parameters.....	153
USB Device Type.....	153
USB CDC Host Variant.....	155

Symbol Native API (SNAPI) Status Handshaking.....	155
USB Keystroke Delay.....	156
USB Caps Lock Override.....	156
USB Barcodes with Unknown Characters.....	157
USB Convert Unknown to Code 39.....	157
USB Fast HID.....	158
USB Polling Interval.....	158
Keypad Emulation.....	160
USB Quick Keypad Emulation.....	160
Keypad Emulation with Leading Zero.....	161
USB Keyboard FN1 Substitution.....	161
USB Function Key Mapping.....	162
USB Simulated Caps Lock.....	162
USB Convert Case.....	163
USB Static CDC.....	163
TGCS (IBM) USB Direct I/O Beep.....	164
TGCS (IBM) USB Beep Directive.....	164
TGCS (IBM) USB Barcode Configuration Directive.....	165
TGCS (IBM) USB Specification Version.....	165
Product ID (PID) Type.....	166
Product ID (PID) Value.....	166
ECLevel.....	167
USB ASCII Character Sets.....	167
SSI Interface.....	168
Communication.....	168
SSI Commands.....	168
SSI Transactions.....	169
General Data Transactions.....	169
Decoded Data Transmission.....	170
Communication Summary.....	171
RTS/CTS Lines.....	171
ACK/NAK Option.....	172
Number of Data Bits.....	172

Serial Response Timeout.....	172
Retries.....	172
Baud Rate, Stop Bits, Parity, Response Timeout, ACK/NAK Handshaking.....	172
Errors.....	172
SSI Communication Notes.....	172
Using Time Delay to Low Power Mode with SSI.....	173
Encapsulation of RSM Commands/Responses over SSI.....	173
Command Structure.....	173
Response Structure.....	174
Example Transaction.....	174
Setting SSI Parameters.....	175
SSI Scanning Sequence Examples.....	176
SSI Errors While Scanning.....	176
Simple Serial Interface Parameter Defaults.....	176
SSI Host Parameters.....	177
Select SSI Host.....	177
SSI Baud Rate.....	177
SSI Parity.....	178
Check Parity.....	179
SSI Stop Bits.....	179
Software Handshaking.....	179
Host RTS Line State.....	180
Decode Data Packet Format.....	180
Host Serial Response Timeout (SSI).....	181
Host Character Timeout.....	181
Multipacket Option.....	182
Interpacket Delay.....	183
Event Reporting.....	183
Decode Event.....	184
Boot Up Event.....	184
Parameter Event.....	184
RS-232 Interface.....	186
Connecting an RS-232 Interface.....	187

RS-232 Parameter Defaults.....	188
RS-232 Host-Specific Parameter Settings.....	188
RS-232 Host Types.....	191
RS-232 Baud Rate.....	192
RS-232 Parity.....	193
RS-232 Stop Bits.....	194
Data Bits.....	194
Check Receive Errors.....	194
Hardware Handshaking.....	195
Software Handshaking.....	196
RS-232 Host Serial Response Timeout.....	197
RTS Line State.....	198
Beep on <BEL>.....	198
Intercharacter Delay.....	199
Nixdorf Beep/LED Options.....	199
RS-232 Barcodes with Unknown Characters.....	200
Datalogic Host Format.....	200
Datalogic Supported Commands.....	200
RS-232 ASCII Character Sets.....	201
IBM 468X / 469X Interface.....	202
Connecting an IBM 468X/469X Host.....	202
IBM Parameter Defaults.....	203
IBM Host Parameters.....	203
Port Address.....	203
Convert Unknown to Code 39.....	204
RS-485 Beep Directive.....	204
RS-485 Barcode Configuration Directive.....	204
IBM-485 Specification Version.....	205
Keyboard Wedge Interface.....	206
Connecting a Keyboard Wedge Interface.....	206
Keyboard Wedge Parameter Defaults.....	207

Keyboard Wedge Host Parameters.....	208
Keyboard Wedge Host Types.....	208
Barcodes with Unknown Characters.....	208
Keystroke Delay.....	208
Intra-keystroke Delay.....	209
Alternate Numeric Keypad Emulation.....	209
Quick Keypad Emulation (Keyboard Wedge).....	210
Simulated Caps Lock (Keyboard Wedge).....	210
Caps Lock Override.....	210
Convert Case (Keyboard Wedge).....	211
Function Key Mapping (Keyboard Wedge).....	211
FN1 Substitution.....	211
Send Make and Break.....	212
Keyboard Map.....	212
ASCII Character Sets.....	213

Symbologies..... 214

Symbology Parameter Defaults.....	214
Enable/Disable All Code Types.....	219
UPC/EAN/JAN.....	220
UPC-A.....	220
UPC-E.....	220
UPC-E1.....	221
EAN-8/JAN-8.....	221
EAN-13/JAN-13.....	221
Bookland EAN.....	222
Bookland ISBN Format.....	222
ISSN EAN.....	223
Decode UPC/EAN/JAN Supplementals.....	223
User-Programmable Supplementals.....	225
UPC/EAN/JAN Supplemental Redundancy.....	226
UPC/EAN/JAN Supplemental AIM ID Format.....	226
Transmit UPC-A Check Digit.....	227
Transmit UPC-E Check Digit.....	228

Transmit UPC-E1 Check Digit.....	228
Transmit EAN-8 Check Digit.....	229
Transmit EAN-13 Check Digit.....	229
UPC-A Preamble.....	229
UPC-E Preamble.....	230
UPC-E1 Preamble.....	230
Convert UPC-E to UPC-A.....	231
Convert UPC-E1 to UPC-A.....	231
EAN/JAN Zero Extend.....	232
UCC Coupon Extended Code.....	232
Coupon Report.....	233
UPC Reduced Quiet Zone.....	233
Code 128.....	234
Set Lengths for Code 128.....	234
GS1-128 (formerly UCC/EAN-128).....	235
ISBT 128.....	236
ISBT Concatenation.....	236
Check ISBT Table.....	237
ISBT Concatenation Redundancy.....	237
Code 128 <FNC4>.....	237
Code 128 Security Level.....	238
Code 128 Reduced Quiet Zone.....	239
Ignore Code 128 <FNC4>.....	239
Code 39.....	240
Trioptic Code 39.....	240
Convert Code 39 to Code 32.....	240
Code 32 Prefix.....	241
Set Lengths for Code 39.....	241
Code 39 Check Digit Verification.....	242
Transmit Code 39 Check Digit.....	243
Code 39 Full ASCII Conversion.....	243
Code 39 Security Level.....	244
Code 39 Reduced Quiet Zone.....	245
Code 93.....	245

Set Lengths for Code 93.....	245
Code 11.....	246
Set Lengths for Code 11.....	247
Transmit Code 11 Check Digits.....	248
Code 11 Check Digit Verification.....	248
Interleaved 2 of 5 (I 2 of 5).....	249
Set Lengths for Interleaved 2 of 5 (I 2 of 5).....	249
Interleaved 2 of 5 (I 2 of 5) Check Digit Verification.....	250
Transmit I 2 of 5 Check Digit.....	251
Convert Interleaved 2 of 5 (I 2 of 5) to EAN-13.....	251
Febraban.....	252
Interleaved 2 of 5 (I 2 of 5) Security Level.....	252
Interleaved 2 of 5 (I 2 of 5) Reduced Quiet Zone.....	253
Discrete 2 of 5 (D 2 of 5).....	254
Set Lengths for Discrete 2 of 5 (D 2 of 5).....	254
Codabar (NW - 7).....	255
Set Lengths for Codabar.....	255
CLSI Editing.....	256
NOTIS Editing.....	257
Codabar Security Level.....	257
Codabar Upper or Lower Case Start/Stop Characters.....	258
MSI.....	259
Set Lengths for MSI.....	259
MSI Check Digits.....	260
Transmit MSI Check Digit(s).....	261
MSI Check Digit Algorithm.....	261
MSI Reduced Quiet Zone.....	261
Chinese 2 of 5.....	262
Matrix 2 of 5.....	262
Set Lengths for Matrix 2 of 5.....	263
Matrix 2 of 5 Check Digit.....	264
Transmit Matrix 2 of 5 Check Digit.....	264
Korean 3 of 5.....	265
Inverse 1D.....	265

GS1 DataBar.....	266
GS1 DataBar Omnidirectional (formerly GS1 DataBar-14).....	266
GS1 DataBar Limited.....	266
GS1 DataBar Expanded.....	266
Convert GS1 DataBar to UPC/EAN/JAN.....	267
GS1 DataBar Security Level.....	267
GS1 DataBar Limited Margin Check.....	268
GS1 DataBar Expanded Security Level.....	269
Symbology-Specific Security Features.....	270
Redundancy Level.....	270
Security Level.....	271
1D Quiet Zone Level.....	272
Intercharacter Gap Size.....	272
Composite.....	273
Composite CC-C.....	273
Composite CC-A/B.....	273
Composite TLC-39.....	274
Composite Inverse.....	274
UPC Composite Mode.....	274
Composite Beep Mode.....	275
GS1-128 Emulation Mode for UCC/EAN Composite Codes.....	275
2D Symbologies.....	276
PDF417.....	276
MicroPDF417.....	276
Code 128 Emulation.....	277
Data Matrix.....	277
GS1 Data Matrix.....	278
Data Matrix Inverse.....	278
Decode Data Matrix Mirror Images.....	279
Maxicode.....	279
QR Code.....	280
Weblink QR.....	280
GS1 QR.....	280
MicroQR.....	281

Linked QR Mode.....	281
Aztec.....	282
Aztec Inverse.....	282
Han Xin.....	283
Han Xin Inverse.....	283
Grid Matrix.....	284
Grid Matrix Inverse.....	284
Grid Matrix Mirrored.....	285
DotCode.....	285
DotCode Prioritize.....	285
DotCode Inverse.....	286
DotCode Mirrored.....	286
Macro PDF Features.....	287
Escape Characters.....	287
Flush Macro PDF Buffer.....	288
Abort Macro PDF Entry.....	288
Postal Codes.....	288
US Postnet.....	289
US Planet.....	289
Transmit US Postal Check Digit.....	289
UK Postal.....	290
Transmit UK Postal Check Digit.....	290
Japan Postal.....	290
Australia Post.....	291
Australia Post Format.....	291
Netherlands KIX Code.....	292
USPS 4CB/One Code/Intelligent Mail.....	292
UPU FICS Postal.....	293
Mailmark.....	293
Intelligent Document Capture (Hand-Held Mode Only).....	294
The Intelligent Document Capture (IDC) Process.....	294
Barcode Acceptance Test.....	294
Capture Region Determination.....	295

Image Post Processing.....	296
Data Transmission.....	296
PC Application and Programming Support.....	296
Image Document Capture Parameter Defaults.....	296
IDC Operating Mode.....	297
IDC Symbology.....	298
IDC X Coordinate.....	299
IDC Y Coordinate.....	299
IDC Width.....	299
IDC Height.....	300
IDC Aspect.....	300
IDC File Format Selector.....	300
IDC Bits Per Pixel.....	301
IDC JPEG Quality.....	301
IDC Find Box Outline.....	301
IDC Minimum Text Length.....	302
IDC Maximum Text Length.....	302
IDC Captured Image Brighten.....	303
IDC Captured Image Sharpen.....	303
IDC Border Type.....	303
IDC Delay Time.....	304
IDC Zoom Limit.....	304
IDC Maximum Rotation.....	305
Quick Start.....	305
Sample IDC Setup.....	305
IDC Demonstrations.....	306
Other Suggestions.....	307
Quick Start Form.....	308
OCR Programming.....	309
OCR Programming Defaults.....	309
OCR Programming Parameters.....	310
OCR-A.....	310
OCR-A Variant.....	310

OCR-B.....	311
OCR-B Variant.....	312
MICR E13B.....	315
US Currency Serial Number.....	316
OCR Orientation.....	316
OCR Lines.....	317
OCR Minimum Characters.....	317
OCR Maximum Characters.....	318
OCR Subset.....	318
OCR Quiet Zone.....	319
OCR Template.....	319
OCR Check Digit Modulus.....	328
OCR Check Digit Multiplier.....	328
OCR Check Digit Validation.....	329
Inverse OCR.....	333
OCR Redundancy.....	334
Driver’s License Set Up.....	335
Driver’s License Parsing.....	335
Parsing Driver’s License Data Fields (Embedded Driver's License Parsing).....	336
Embedded Driver's License Parsing Criteria - Code Type.....	336
Driver’s License Parse Rules.....	336
Driver’s License Parse Fields.....	337
AAMVA Parse Fields.....	338
Parser Version ID Barcode.....	345
DL Parsing User Preferences.....	345
Set Default Parameter.....	345
Output Gender as M or F.....	346
Date Format.....	346
Send Keystroke (Control Characters and Keyboard Characters).....	348
Parsing Rule Example.....	361
Embedded Driver's License Parsing ADF Example.....	364

Country Codes.....	366
USB and Keyboard Wedge Country Keyboard Types (Country Codes).....	366
Country Code Barcodes.....	366
Country Code Pages.....	378
Country Code Page Defaults.....	378
Country Code Page Barcodes.....	381
CJK Decode Control.....	387
CJK Control Parameters.....	387
Unicode Output Control.....	387
CJK Output Method to Windows Host.....	387
Non-CJK UTF Barcode Output.....	389
Unicode/CJK Decode Setup with Windows Host.....	390
Setting Up the Windows Registry Table for Unicode Universal Output.....	390
Adding CJK IME on Windows.....	391
Selecting the Simplified Chinese Input Method on the Host.....	391
Selecting the Traditional Chinese Input Method on the Host.....	392
Programming Reference.....	394
Symbol Code Identifiers.....	394
AIM Code Identifiers.....	395
Sample Barcodes.....	400
Sample Code 39.....	400
Sample Code 93.....	400
Sample UPC/EAN.....	400
Sample Code 128.....	402
Sample Interleaved 2 of 5.....	402
Sample Chinese 2 of 5.....	402
Sample Matrix 2 of 5.....	403
Sample Korean 3 of 5.....	403
Sample GS1 DataBar.....	403

Sample PDF417.....	404
Sample Data Matrix.....	404
Sample Maxicode.....	404
Sample QR Code.....	404
Sample Aztec.....	405
Sample Grid Matrix.....	405
Postal Codes.....	405
Sample US Postnet.....	405
Sample UK Postal.....	405
Numeric Barcodes.....	406
Cancel.....	407
Alphanumeric Barcodes.....	408
Cancel.....	408
Alphanumeric Barcodes.....	408
ASCII Character Sets.....	419
Communication Protocol Functionality.....	429
Signature Capture Code.....	431
Code Structure.....	431
Signature Capture Area.....	431
CapCode Pattern Structure.....	431
Start / Stop Patterns.....	432
Dimensions.....	433
Data Format.....	433
Additional Capabilities.....	433
Signature Boxes.....	434
Non-Parameter Attributes.....	435

Model Number.....	435
Serial Number.....	435
Date of Manufacture.....	435
Date of First Programming.....	436
Configuration Filename.....	436
Beeper/LED.....	437
Parameter Defaults.....	437
Beep on Next Bootup.....	438
Reboot.....	438
Host Trigger Session.....	438
Firmware Version.....	438
Scankit Version.....	439

Introduction

The DS4678 Product Reference Guide provides general instructions for setting up, operating, maintaining, and troubleshooting the DS4678 scanner.

Some parts of this guide are intended for use by a system engineer/programmer and go into detail concerning programming functions.

Configurations

This section lists the configurations of the DS4678 and its accessories.

Digital Scanner

Table 1 Scanner Configurations

Configuration	Description
DS4678-SR00007ZZWW	Area imager, standard range, cordless, Twilight Black
DS4678-DL00007ZZWW	Area imager, DLParsing Cordless, Twilight Black
DS4678-DPE0007VZRW	Area imager, Electronics DPM, cordless, white illumination, Twilight Black, vibration
DS4678-XD40007VZCN	Area imager, extreme density, cordless, white illumination, Twilight Black, vibration
DS4678-XD40007VZAP	Area imager, extreme density, cordless, white illumination, Twilight Black, vibration
DS4678-SR00007ZZCN	Area imager, standard range, cordless, Twilight Black, China only
DS4678-SR00997ZZCN	Area imager, standard range, cordless, Twilight Black, China project only
DS4678-SR00007ZZK	Area imager, standard range, cordless, Twilight Black, India and Korea only
DS4678-XD400007VZK	Area imager, extreme density, cordless, white illumination, Twilight Black, vibration, India and Korea only

Cradles

Table 2 Cradle Configurations

Configuration	Description
CR8178-SC100F4WW	Cradle, CR8178, Standard, Bluetooth, Midnight Black
CR8178-PC100F4WW	Cradle, CR8178, Presentation, Bluetooth, Midnight Black

Related Product Line Configurations

Table 3 Accessories

Configuration	Description
CBA-R01-S07PBR	Cable - RS232. DB9F, 2 m (7 ft) ST, TXD-2, W/TTL. Current limit protection.
CBA-R06-C20PBR	Cable - RS232:DB9F, 6 m (20 ft) CL, TXD-2, W/TTL. Current limit protection.
CBA-U21-S07ZBR	Cable - Shielded USB: Series A connector, 2.1 m (7 ft), straight, BC1.2.
CBA-U30-S15ZBR	Cable - Shielded USB: Series A connector, 4.6 m (15 ft), straight.
PWR-WUA5V4W0US	5 V power supply.
PWR-BGA12V50W0WW	12 V power supply.
23844-00-00R	AC cable for use with 12 V power supply.
CBL-DC-451A1-01	DC jack for use with 12 V power supply.
BTRY-DS81EAB0E-00	Replacement battery for the DS4678 scanner (worldwide).
 NOTE: For compatible power supplies, contact your Zebra sales representative.	

Cables

For regional information about cables and cable compatibility, go to the [Zebra Partner Portal](#).

Notational Conventions

The following notational conventions make the content of this document easy to navigate.

- **Bold** text is used to highlight the following:
 - Dialog box, window, and screen names
 - Dropdown list and list box names
 - Checkbox and radio button names
 - Icons on a screen
 - Key names on a keypad
 - Button names on a screen
- Bullets (•) indicate:
 - Action items
 - List of alternatives
 - Lists of required steps that are not necessarily sequential.
- Sequential lists (for example, those that describe step-by-step procedures) appear as numbered lists.

Icon Conventions

The documentation set is designed to give the reader more visual clues. The following visual indicators are used throughout the documentation set.



NOTE: The text here indicates information that is supplemental for the user to know and that is not required to complete a task.



IMPORTANT: The text here indicates information that is important for the user to know.



CAUTION: If the precaution is not heeded, the user could receive a minor or moderate injury.



WARNING: If danger is not avoided, the user CAN be seriously injured or killed.



DANGER: If danger is not avoided, the user WILL be seriously injured or killed.

Service Information

If you have a problem with your equipment, contact Zebra Global Customer Support for your region. Contact information is available at: zebra.com/support.

When contacting support, please have the following information available:

- Serial number of the unit
- Model number or product name
- Software type and version number

Zebra responds to calls by email, telephone, or fax within the time limits set forth in support agreements.

If your problem cannot be solved by Zebra Customer Support, you may need to return your equipment for servicing and will be given specific directions. Zebra is not responsible for any damages incurred during shipment if the approved shipping container is not used. Shipping the units improperly can possibly void the warranty.

If you purchased your Zebra business product from a Zebra business partner, contact that business partner for support.

Getting Started

The DS4678 combines 1D and 2D omnidirectional barcode scanning performance and advanced ergonomics in a lightweight design. The digital scanner ensures comfort and ease of use for extended periods of time.

Interfaces

The DS4678 digital scanner cradles (CR8178-SC and CR8178-PC) can connect to a host computer using a USB, RS-232, IBM 468/469, or Keyboard Wedge interface.

- USB connection to a host. The digital scanner auto-detects a USB host and defaults to the HID keyboard interface type. Select other USB interface types by scanning the programming barcode menus. Go to [Country Codes](#) for the interface-supported keyboards (for a Windows® environment).



NOTE: Use only compatible Zebra USB cables with a shielded modular connector.

- Standard RS-232 connection to a host. Scan barcode menus to set up the communication of the digital scanner with the host.
- Connection to IBM 468X/469X hosts. Scan barcode menus to set up communication of the digital scanner with the IBM terminal.
- Keyboard Wedge connection to a host. The host interprets scanned data as keystrokes. Scan barcodes to set up communication of the digital scanner with the host. Go to [Country Codes](#) for the interface-supported international keyboards (for a Windows® environment).
- Configuration via 123Scan.



NOTE: For a list of supported scanner functionality by communication protocol, go to [Communication Protocol Functionality](#).

Unpacking

Carefully unpack the scanner.

1. Remove the digital scanner from its packaging and inspect it for damage.

If the scanner was damaged in transit, contact support.

2. Keep the packaging. It is the approved shipping container; use this to return the equipment for servicing.

3. Ensure the box contains the following items:

- DS4678
- Battery
- Regulatory Guide

If equipment is missing or damaged, contact Support immediately. Refer to [Service Information](#) for contact information.

Features

This section lists the features of the DS4678 scanner.



NOTE: Only use the CR8178-SC or CR8178-PC cradles with DS4678 scanners. No other cradles are compatible with the scanner.

Figure 1 Rear View

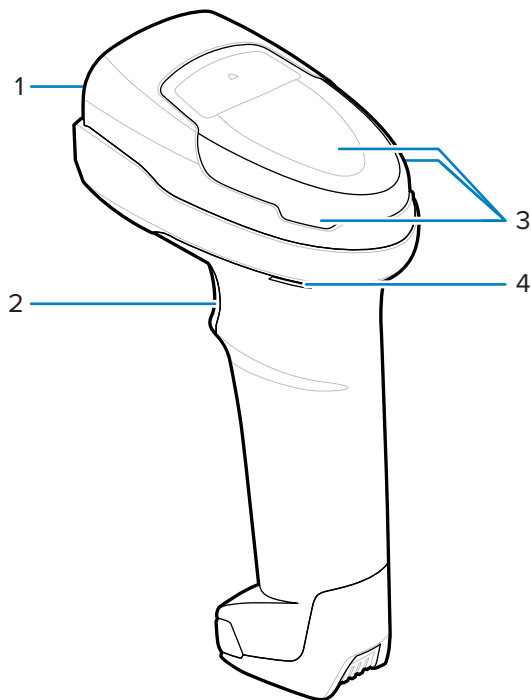

Item	Description
1	Scan window
2	Trigger
3	LEDs
4	Beeper

Cradle Features

This section describes the features of the cradles.

The cradle serves as a charger, radio communication interface, and host communication interface for the DS4678 scanner. There are two versions of the cradle:

- The CR8178-SC cordless cradle sits on a desk or mounts on a wall and charges the DS4678 scanner. This cradle also provides host communication by receiving scanner data via a Bluetooth radio and sending that data to the host through an attached cable. The cable provides power to the cradles from the host or optional power supply if supported.
- The CR8178 cordless presentation cradle sits on a desktop and charges the DS4678 scanner while allowing barcode scanning in presentation mode. This cradle also provides host communication by receiving scanner data via a Bluetooth radio, and sending that data to the host through an attached cable. The cable provides power to the cradle from the boost or optional power supply.



NOTE: Only the CR8178-SC and CR8178-PC cradles are compatible with the scanner.

Standard Cradle

This section lists the features of the standard cradle.

Figure 2 Front View

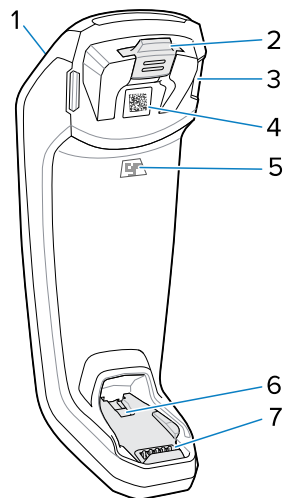

Item	Description
1	LED indicators
2	Removable Scanner Latch (vertical/mobile cart mount position)
3	LED
4	Pairing barcode
5	Page button
6	Scanner lock (when converter knob is set to vertical mount)
7	Charging/communications contacts

Figure 3 Bottom View

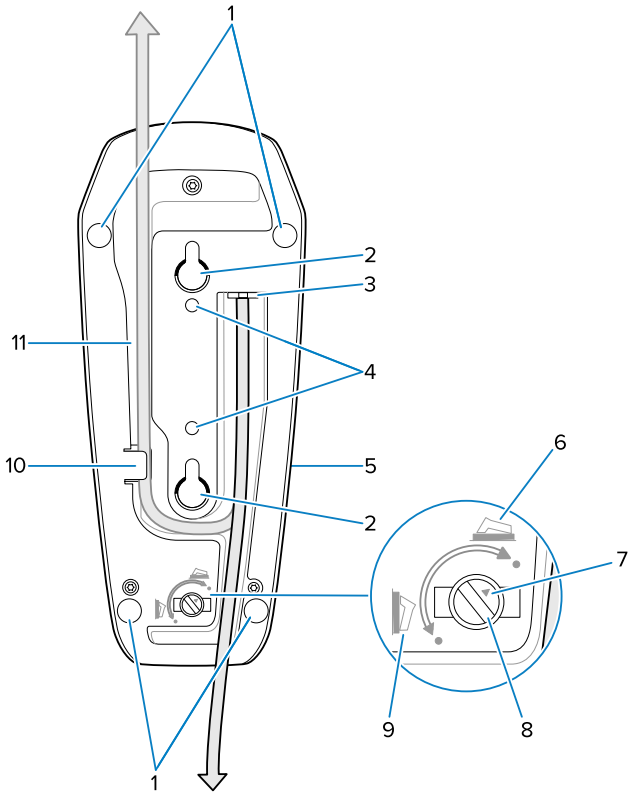

Item	Description
1	Rubber feet
2	Keyhole mounting hole
3	Interface port
4	Vertical mount threaded brass screw holes (2x M4x5 mm)
5	Interface cable groove
6	Desk
7	Triangle indicator
8	Knob
9	Wall or mobile cart
10	Interface cable support hook
11	Interface cable groove

Presentation Cradle

This section describes the features of the Presentation Cradle.

Figure 4 Presentation Cradle Features

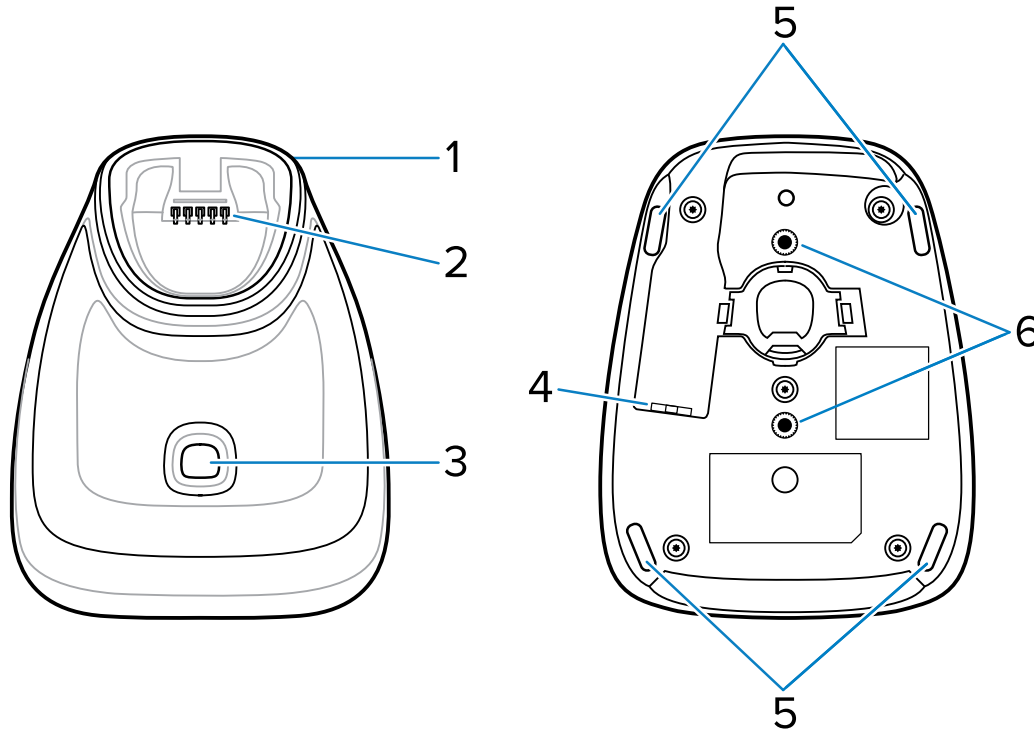

Item	Description
1	Pairing barcode (back)
2	Charging/communications contacts
3	Page button/LED
4	Interface port
5	Rubber feet
6	Station mount threaded brass screw holes (2x M4 x 5 mm)

Connecting the Cradle

Connect the cradle to a host computer.

1. Connect the appropriate cable to the power supply and AC power source, if necessary. This ensures detection of the host and prevents inadvertently back-powering the cradle from improper detection of the host.
2. Insert the interface cable into the host port.
3. Insert the interface cable into the cradle's host port.
4. For the CR8178-SC only, thread the interface cable under the interface cable support hook and run the cable along the interface cable groove (if applicable).

5. Pair the digital scanner to the cradle either by inserting it in the cradle (if Pair on Contacts is enabled) or by scanning the pairing code.
6. If necessary, scan the appropriate host barcode (for non-autodetected interfaces).

Changing the Host Interface

To connect to a different host or to use the same host through a different cable, disconnect from the current host and connect to the new one.

1. Unplug the interface cable from the host.
2. Unplug the power supply from the cradle.
3. Connect the interface cable to the new host or the new interface cable to the existing host.
4. Reconnect the power supply, if required.
5. If necessary, scan the appropriate host barcode (for non-autodetected interfaces).

DC Power Supply

The cradle can operate from host-supplied power.

If host power is limited or not available, an external DC power supply can be used with certain host interface cables that support a power jack. An external power supply is recommended if fastest charging is required.



CAUTION: Always disconnect the DC power supply before disconnecting the cable to the host end, or the cradle may not recognize the new host.

Mounting the Cradle

Mount the cradle using the mounting features illustrated below.

Refer to the documentation included with the cradle.

Figure 5 Mounting Features

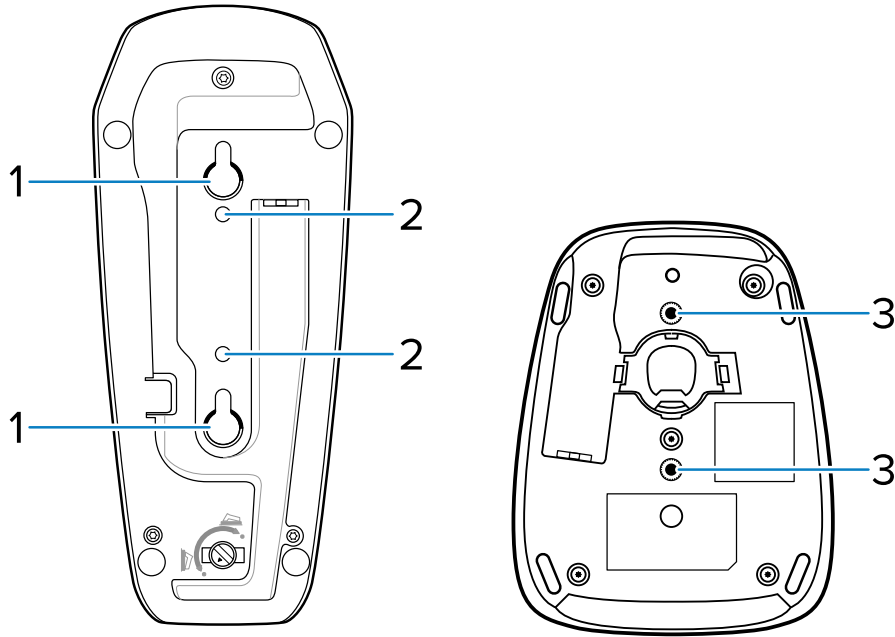

1	Distance = 81 mm (3.2 in.)
2	Distance = 45.5 mm (1.8 in.)
3	Distance = 45.5 mm (1.8 in.)

Battery

This section describes the actions the scanner can perform at different battery levels.

Table 4 Battery Level Scanner Functions

Battery Level	Functions
3 – 100%	Scanning, beeping, and communication with the host device.
0 – 3%	Communication with the host device.
0%	The device shuts down. No communication with the host device. ^a

^a A battery that stays at 0% charge for an extended period of time becomes deeply discharged.



NOTE: A deeply discharged battery will appear to be off after it is placed in a charging cradle. After a few minutes on the charger, the LED blinks red until battery level sufficiently recovers.

Charging the DS4678 Battery

Charge a new PowerPrecision+ battery before using the scanner.

1. Insert the battery into the scanner.
2. Place the scanner into a cradle.

The battery begins pre-charging when the cradle LED turns amber. The scanner boots and the cradle LED flashes amber to indicate the start of normal charging.



NOTE:

- If the battery is significantly discharged it may take several minutes for the scanner to boot. During this time the cradle LED remains solid amber, and the scanner may not show activity. This is normal recovery behavior.

Once the scanner is active, charge time depends on the host type and power source.

- The advanced charging system in the CR8178-XX cradles operate the scanner and charge the battery with as much power as allowed by the host or power supply. Charge times lengthen as scanning activity increases when a DS4678 operates in presentation mode on a CR8178-PC cradle. To optimize charge performance, ensure the scanner is oriented to minimize accidental scan activation.



IMPORTANT: While attached to very power-limited hosts, such as a standard USB port, the scanner may slowly discharge the battery during active scanning. In most cases, this is not a problem since the battery charges during breaks in activity. If activation time cannot be reduced, and discharging becomes a problem, it is recommended to attach to a BC1.2 compliant USB port, or use a Zebra USB cable that supports an external power supply.



CAUTION: The battery does not charge when the temperature is above 40°C (104°F). Ideally, charge the battery in temperatures between 5 and 35°C (41–95°F).

Shutting Off the Battery

Scan the Battery Off barcode to shut off the battery for long-term storage or shipping.

1. Scan to shut off the battery.

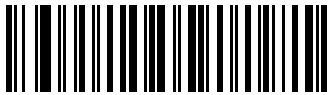

NOTE: Always scan the Battery Off barcode in hand-held mode.

2. Pull the scanner trigger to turn on the battery.

Replacing the Battery

Remove the battery compartment cover to access the rechargeable battery.

1. Use a coin to turn the battery compartment knob counterclockwise until it reaches a hard stop.

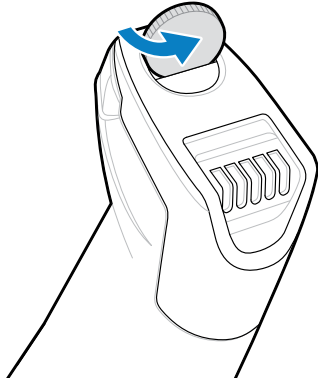

2. Lift the battery compartment cover off.

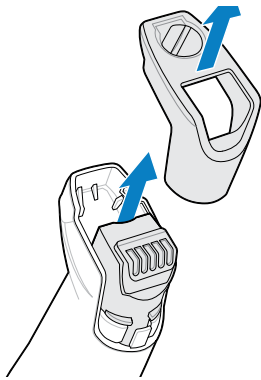

3. Remove the battery from the compartment.

4. Replace the battery.
 - a) Slide the battery into the compartment and push until it clicks into place.
 - b) Ensure the battery compartment knob is in the open position.
 - c) Slide the battery compartment cover into place.

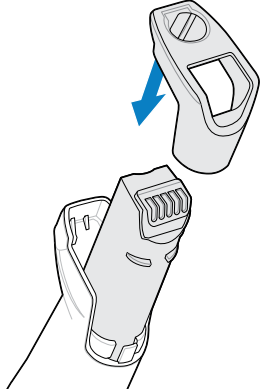

- d) Use a coin to turn the battery compartment knob counterclockwise until it reaches a hard stop.

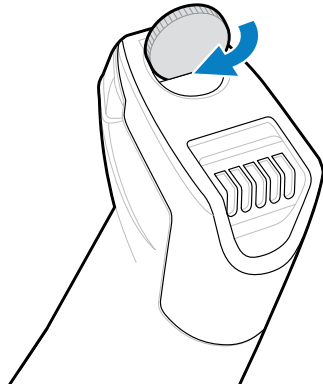

Inserting the Scanner into the CR8178-SC Cradle

The CR8178-SC cradle charges the DS4678. Insert the scanner into the cradle to charge.

1. Insert the scanner into the cradle top first, ensuring that the cradle latch depression connects with the scanner latch on the cradle.
2. Push the handle until it clicks into place, engaging the contacts in the cradle and the scanner.

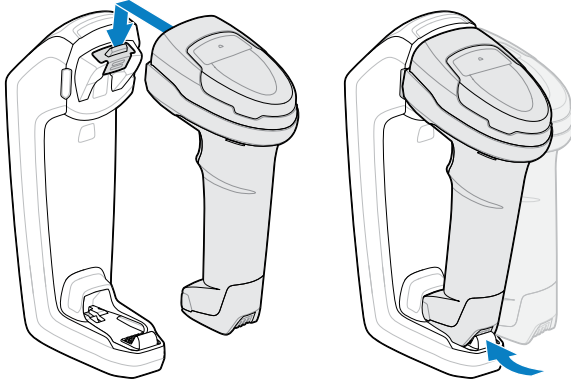

Inserting the Scanner into the CR8178-PC Cradle

Insert the scanner into the cradle and allow it to rotate forward slightly.

1. Insert the scanner straight down into the cradle top.
2. The digital scanner naturally rotates forward to engage the digital scanner contacts with the cradle contacts.

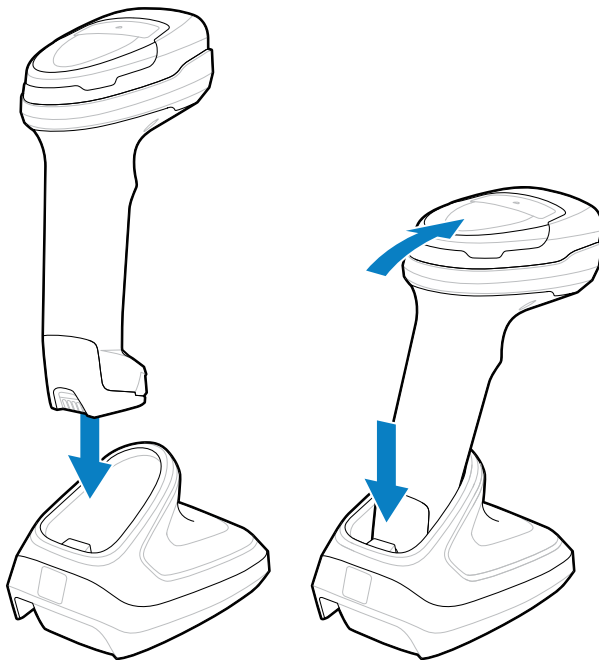

Host Computer Communication

The digital scanner must pair with the cradle for successful wireless communication.

The cradle receives data from the digital scanner via a wireless radio connection and transmits it to the host computer via the host cable.

Pairing

Pairing is the process by which a scanner initiates communication with a cradle.

Scanning Multipoint-to-Point activates multi-scanner-to-cradle operation and allows up to seven scanners to pair.

To pair the scanner with the cradle, scan the pairing barcode on the cradle. The scanner emits a high/low/high/low beep sequence to indicate that it decoded the pairing barcode and then a low/high beep when it establishes a connection with the cradle.



NOTE: Each cradle uses a unique pairing barcode. Do not scan data or parameters until pairing completes. When the scanner pairs with the cradle in SPP Central or Cradle Host mode, it attempts to reconnect to a remote device upon a disconnection due to the radio losing communication. For more information, see [Auto Reconnect Parameters](#).

Reconnecting to the Host

Reestablish a connection with the host computer by disconnecting and reconnecting the cradle.

1. Disconnect the power supply from the cradle.
2. Disconnect the host interface cable from the cradle.
3. Wait 3 seconds.
4. Reconnect the host interface cable to the cradle.
5. Reconnect the power supply to the cradle.
6. Reestablish pairing with the cradle by inserting the scanner in the cradle or scanning the pairing barcode.

Pairing on insertion into the cradle is enabled by default.

Data Capture

This section provides beeper and LED definitions, techniques for scanning barcodes, general instructions and tips for scanning, and decode ranges.

Scanner Indications

This section lists the meanings of the scanner's indications.

Table 5 Scanner Beeper and LED Indications

Beeper Sequence	LED	Indication
Standard Use		
Low, medium, high	Green	Powering on.
Scanning		
None	Green solid	Presentation mode on.
None	No LED; green LED turned off	Presentation mode off.
Medium ^a	Green flash	Successful barcode decode.
Low, low, low, extra low	Red	Parity error.
Four long low beeps	Red	Transmission error in a scanned symbol. The data is ignored. This occurs if a unit is not properly configured. Check option setting.
Five long low beeps	Red	Conversion or format error.
None	Red flash on trigger pull	Scanner is disabled by a host command to the scanner.
High	None	A <BEL> character is received over RS-232.
Wireless Operation		
Low, high, low, high	Red	Out of batch storage memory, unable to store new barcode.
Radio Indications		
Low	None	Scanner inserted into a cradle ^a .

Table 5 Scanner Beeper and LED Indications (Continued)

Beeper Sequence	LED	Indication
Low, high	Green	Bluetooth connection established.
High, low	Red	Bluetooth disconnection event.
Long low, long high	Red	Bluetooth page timeout; the remote device is out of range/ not powered.
Long low, long high, long low, long high	None	Bluetooth connection attempt rejected by the remote device.
None	Green flash	Bluetooth attempting reconnection.
Five high	None	Bluetooth attempting reconnection (disabled by default).
Six high	Blue (fast, fast, slow)	Paging.
Remaining Charge Indications		
Four short high beeps	Red (stays on)	Low battery indication (on trigger release).
None	Red (slow blink)	Scanner is charging in cradle; charge remaining between 0 - 3%.
Parameter Programming		
Long low, long high	Red	Input error, incorrect barcode or Cancel scanned, wrong entry, incorrect barcode programming sequence; remain in program mode.
High, low	Green	Keyboard parameter selected. Enter a value using barcode keypad.
High, low, high, low	Green	Successful program exit with a change in the parameter setting.
ADF Programming		
Low, high, low	None	ADF transmit error.
High, low	Green	Number expected. Enter another digit. Add leading zeros at the beginning if necessary.
Low, low	Green	Alpha expected. Enter another alphabetic character or scan the End of Message barcode.
High, high	Green blinking	ADF criteria or action is expected. Enter another criteria or action or scan the Save Rule barcode.

Table 5 Scanner Beeper and LED Indications (Continued)

Beeper Sequence	LED	Indication
High low low	Green	All criteria or actions cleared for current rule, continue entering rule.
High, low, high, low	Green (turns off blinking)	Rule saved. Rule entry mode exited.
Long low, long high	Red	Rule error. Entry error, wrong barcode scanned, or criteria/action list is too long for a rule. Re-enter criteria or action.
Low beep	Green	Deleted last saved ruled. The current rule is left intact.
Low, high, high	Green	All rules deleted.
Long low, long high, long low, long high	Red	Out of rule memory. Erase some existing rules, then try to save the rule again.
Low low, long high, long low	Green (turns off blinking)	Cancel rule entry. Rule entry mode exited because of an error, or the user asked to exit rule entry.
Host-Specific		
USB Only		
Four high beeps	None	The scanner has not completed initialization. Wait several seconds and try again.
RS-232 Only		
High, high, high, low	Red	RS-232 receive error.
High	None	A <BEL> character is received when Beep on <BEL> is enabled (Point-to-Point mode only).
Virtual Tether Alarm		
High, low, continuous	Fast blinking alternating green and red	The scanner disconnects over Bluetooth from the cradle (Virtual Tether Alarm enabled).  NOTE: Virtual Tether Alarm, when enabled, activates on the scanner and cradle.

^a This setting is configurable.

Cradle LED Indications

This table describes the CR8178-PC and CR8178-SC status LED indications.

Table 6 Cradle LED Indications

LED	Indication
Standard Use	
Green (stays on)	Power Up
Radio Indications	
Green (off, then on)	Bluetooth connection established
Blue	Page button
Blue (fast/fast/slow)	Page issued
Charging Indications	
Amber (stays on)	Pre-charging
Amber blinking	Charging
Green (stays on)	Fully charged
Amber fast blinking	Charging error. See Troubleshooting for more information.
Red blinking	The battery is charging, but it is at end of life. Replace it with a new battery.
Red fast blinking	The cradle is either not providing current to the scanner, or the scanner is consuming more current than the cradle can supply (see Troubleshooting for more information).
Virtual Tether Alarm	
Fast blinking alternating green and red	The scanner disconnects over Bluetooth from the cradle (Virtual Tether Alarm enabled)
Maintenance Indications	
Red (stays on)	Enable boot loader
Red blinking	Firmware installation

Table 7 Host-Controlled Cradle LED Indications

LED	Indication
123Scan	
Green (slow blinking)	Scanner connected to 123Scan
Red (fast blinking)	File being transferred to the scanner (parameters and firmware)
Red (slow blinking)	Firmware activated on the scanner, loaded into memory
Green	Programming complete (parameters and firmware)

Table 7 Host-Controlled Cradle LED Indications (Continued)

LED	Indication
Red	Error state
SMS	
Red blinking (both scanner and cradle)	Loading the SMS package to scanner

Hands-Free Scanning

The scanner is in hands-free (presentation) mode when it sits in the CR8178-PC cradle. During idle conditions, the scanner operates in object detection mode and automatically wakes up to decode a barcode presented in the field of view. In object detection mode, it is normal for the illumination LEDs to be dimly lit.

1. Ensure all connections are secure (see appropriate host section).
2. Present the barcode in the scanner field of view.
3. Upon successful decode, the scanner beeps and the LED flashes green.

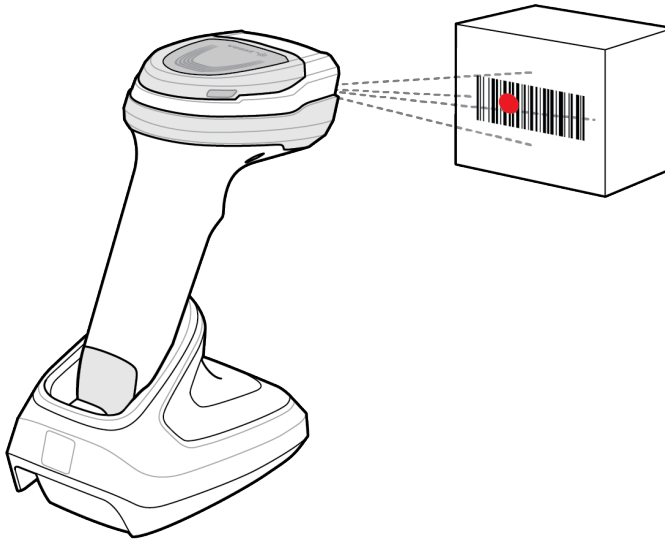

Hand-Held Scanning

The scanner is in hand-held mode when you pick it up out of a cradle.

1. Pair the scanner with the device. See [Pairing](#) for more information.

2. Point the scanner at a barcode.

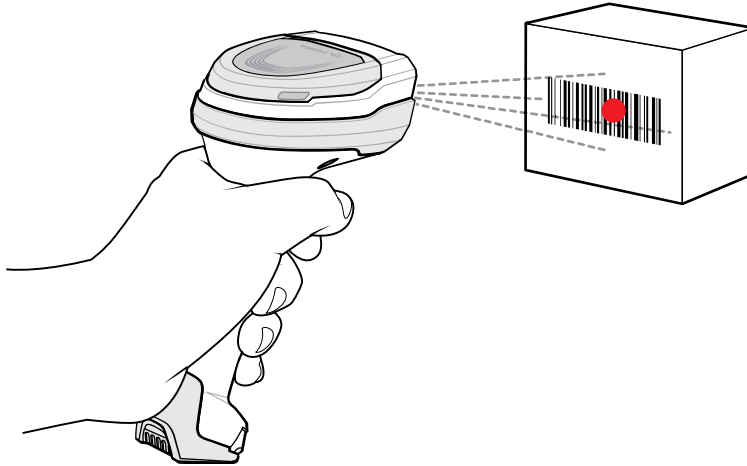

3. Press and hold the trigger.
4. Ensure the barcode is within the area formed by the aiming pattern. The aiming dot increases visibility in bright lighting conditions.

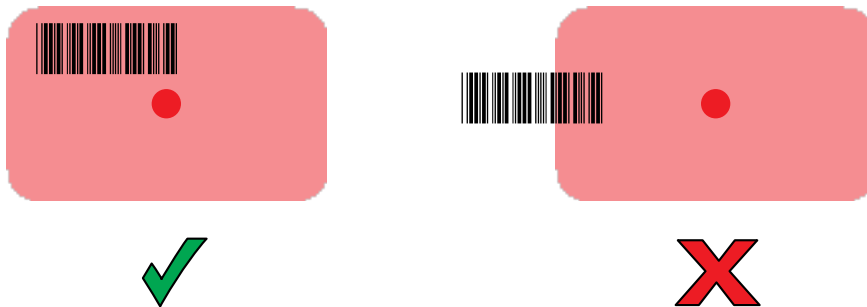

5. Upon successful decode, the scanner beeps, and the LED flashes.

Aiming

When scanning, the DS4678 projects a red LED dot, allowing you to position the barcode within the scanner's field of view. Refer to Decode Ranges for the proper distance between the scanner and a barcode.

If necessary, the scanner turns on its red illumination LEDs to illuminate the barcode. The scanner decodes barcodes only when the dot is on the barcode. The top example in [Figure: Scanner Aiming](#) shows an acceptable aiming option, while the bottom example shows an aiming pattern that will not decode.

Figure 6 Scanner Aiming



The aiming dot is smaller when the scanner is closer to the barcode and larger when it is farther away. Scan barcodes with smaller bars or elements (mil size) closer to the scanner and those with larger bars or elements (mil size) farther from the scanner.

The scanner beeps to indicate that it successfully decoded the barcode. For more information on beeper and LED definitions, see the [Scanner Indications Table](#).

Decode Ranges

This section lists the distances at which the scanner can decode various barcode types.

Table 8 Scanner Decode Ranges

Barcode Type	Symbol Density	DS4678SR/DL Typical Working Range		DS4678-DPE Typical Working Range	
		Near (cm / in.)	Far (cm / in.)	Near (cm / in.)	Far (cm / in.)
Code 128	2.0 mil	N/A	N/A	0.3 / 0.8	2.3 / 5.8
	3.0 mil	2.7 / 6.8	5.4 / 13.7	0.0 / 0.0	3.5 / 8.8
	15 mil	N/A	N/A	4.2 / 10.7	8.6 / 21.8
Code 39	2.0 mil	N/A	N/A	0.2 / 0.5	3.0 / 7.6
	3.0 mil	2.2 / 5.5	5.4 / 13.7	0.0 / 0.0	3.8 / 9.6
	5.0 mil	0.7 / 1.8	11.0 / 27.9	0.0 / 0.0	5.2 / 13.2
	20.0 mil	0.0 / 0.0	44.0 / 111.7	N/A	N/A
100% UPC	13.0 mil	0.0 / 0.0	28.0 / 71.1	0.0 / 0.0	8.5 / 21.5
PDF417	4.0 mil	N/A	N/A	0.0 / 0.0	3.3 / 8.4
	5.0 mil	N/A	N/A	0.0 / 0.0	3.8 / 9.6
	6.6 mil	1.3 / 3.3	10.0 / 25.4	0.0 / 0.0	4.5 / 11.4

Table 8 Scanner Decode Ranges (Continued)

Barcode Type	Symbol Density	DS4678SR/DL Typical Working Range		DS4678-DPE Typical Working Range	
		Near (cm / in.)	Far (cm / in.)	Near (cm / in.)	Far (cm / in.)
Data Matrix	4.0 mil	N/A	N/A	0.2 / 0.5	2.8 / 7.1
	5.0 mil	2.8 / 7.1	5.0 / 12.7	0.0 / 0.0	3.4 / 8.6
	7.5 mil	2.0 / 5.0	8.5 / 21.5	N/A	N/A
	10.0 mil	1.0 / 2.5	11.5 / 29.2	0.0 / 0.0	4.8 / 12.2
QR Code	10.0 mil	1.0 / 2.5	9.0 / 22.8	0.0 / 0.0	4.5 / 11.44
	20.0 mil	0.0 / 0.0	17.5 / 44.4	N/A	N/A

123Scan and Software Tools

This section describes the Zebra software tools available for customizing scanner operation.

123Scan

123Scan is a software tool that simplifies scanner setup and more.

Intuitive enough for first-time users, the 123Scan wizard guides users through a streamlined setup process. Settings are saved in a configuration file that can be printed as a single programming barcode for scanning, emailed to a smart phone for scanning from its screen or downloaded to the scanner using a USB cable.

Through 123Scan a user can:

- Configure a scanner using a wizard.
 - Program the following scanner settings.
 - Beeper tone/volume settings.
 - Enable/disable symbologies.
 - Communication settings.
 - Modify data before transmission to a host using:
 - Advanced Data Formatting (ADF) - Scan one barcode per trigger pull.
 - Multicode Data Formatting (MDF) - Scan many barcodes in one trigger pull (select scanners).
 - Preferred Symbol - Single out one barcode on a label of many (select scanners).
- Load parameter settings to a scanner via the following:
 - Barcode scanning.
 - Scan a paper barcode.
 - Scan a barcode from a PC screen.
 - Scan a barcode from a smart phone screen.
 - Download over a USB cable.
 - Load settings to one scanner.
 - Stage up to 10 scanners simultaneously (Powered USB Hub recommended with 0.5 amp / port).

- Validate scanner setup.
 - View scanned data within the utility's Data view screen.
 - Capture an image and save it to a PC within the utility's Data view screen.
 - Review settings using the Parameter Report.
 - Clone settings from an already deployed scanner from the Start screen.
- Upgrade scanner firmware.
 - Load settings to one scanner.
 - Stage up to 10 scanners simultaneously (Powered USB Hub recommended with 0.5 amp/port).
- View statistics, such as:
 - Asset tracking information.
 - Time and usage information.
 - Barcodes scanned by symbology.
- Generate the following reports.
 - Barcode Report - Programming barcode, relevant parameter settings, and supported scanner models.
 - Parameter Report - Parameters programmed within a configuration file.
 - Inventory Report - Scanner asset tracking information.
 - Validation Report - Scanned data from the Data view.
 - Statistics Report - All statistics retrieved from the scanner.

For more information, go to zebra.com/123Scan.

Communication with 123Scan

Use a USB cable to connect the scanner to a Windows host computer running 123Scan.

123Scan Requirements

- Host computer running Windows 10 or 11
- Scanner
- USB cable

123Scan Information

Use these links to learn more about using 123Scan and Zebra software tools.

For more information on 123Scan, go to zebra.com/123Scan

For a one-minute tour of 123Scan, go to zebra.com/ScannerHowToVideos

To see a list of all of our software tools, go to zebra.com/scannersoftware

Scanner SDK, Other Software Tools, and Videos

Tackle all your scanner programming needs with our diversified set of software tools. Whether you need to stage a device or develop a fully featured application with image and data capture and asset management, these tools help you every step of the way.

To download any of the following free tools, go to: zebra.com/scannersoftware.

- 123Scan configuration utility
- SDKs
 - Scanner SDK for Windows
 - Scanner SDK for Linux
 - Scanner SDK for Android
 - Scanner SDK for iOS
- Drivers
 - OPOS driver
 - JPOS driver
 - USB CDC driver
- Scanner Management Service (SMS) for Remote Management
 - Windows
 - Linux
- Mobile Apps
 - Scanner Control App
 - Android
 - iOS
 - Scan-To-Connect Utility
 - Android
 - Windows
- How-To-Videos



NOTE: For a list of SDK-supported scanner functionality by communication protocol, see .

Scanner Control App

The Scanner Control App (SCA) lets you control a Bluetooth scanner from a phone or tablet without a cradle. Use this app to showcase a Zebra Bluetooth scanner's capabilities and ease of control from your phone.

The SCA supports Scan-To-Connect (see [Scan-to-Connect Utility](#)) technology for one-step Bluetooth pairing, and allows you to control the following scanner functions:

- Program the beeper and LEDs.
- Enable and disable symbologies.

- Remotely trigger a scan.

The app displays scanned barcode data and can query scanner asset information and battery health statistics.

The SCA also works with USB-connected scanners such as the MP7000 if the Android tablet has a powered USB host port.

The SCA is available on the Google Play, iOS App, and Zebra AppGallery stores. Source code is available within the Zebra Scanner SDK for Android and iOS.

To watch a 1-minute tour of the Scanner Control App, go to: zebra.com/scannercontrolapp.

Scan-To-Connect Utility

In one step, connect your Zebra Bluetooth scanner to a phone, tablet, or PC by simply scanning a Scan-To-Connect (STC) barcode. Available as a standalone utility for Windows and Android operating systems from zebra.com/scantoconnect.

Source code is also available for easy app integration.



NOTE: The STC Utility allows you to pair a Bluetooth scanner to a phone, tablet, or PC without using a cradle.

Maintenance, Troubleshooting, and Specifications

This section provides suggested imaging scanner maintenance, troubleshooting, technical specifications, and signal descriptions (pinouts).

Maintenance

Keep the DS4678 clean and dry to ensure error-free scanning.



IMPORTANT: Use pre-moistened wipes and do not allow liquid cleaner to pool.

- Ensure the following items are addressed when using sodium hypochlorite (bleach)-based cleaners:
 - For scanner only. Do not use on cradle.
 - Always follow the manufacturer's recommended instructions: use gloves during application and remove the residue afterward with a damp cloth to avoid prolonged skin contact while handling the scanner.
 - Due to the powerful oxidizing (corrosion) when exposed to this chemical in the liquid form (including wipes) and should be avoided. In the event that these type of disinfectants come in contact with metal on the scanner, it is critical to remove the disinfectants quickly with a dampened cloth.



REMEMBER: To avoid damage to the device, use only approved cleaning and disinfecting agents listed below. The use of non-approved cleaning or disinfecting agents may void the warranty.

Known Harmful Ingredients

This section lists substances that should be prevented from coming into contact with the device.

- Acetone
- Ammonia solutions
- Aqueous or alcoholic alkaline solutions
- Aromatic and chlorinated hydrocarbons
- Benzene
- Carboic acid
- Compounds of amines or ammonia

- Ethanolamine
- Ethers
- Ketones
- TB-lysoform
- Toluene
- Trichloroethylene

Cleaning the Scanner

Routinely cleaning the exit window is required. A dirty window may affect scanning accuracy. Do not allow any abrasive material to touch the window.

1. Dampen a soft cloth with isopropyl alcohol or use pre-moistened alcohol wipes.
2. Gently wipe all surfaces, including the front, back, sides, top, and bottom. Never apply liquid directly to the scanner. Be careful not to let liquid pool around the scanner window, trigger, cable connector or any other area on the device.
3. Be sure to clean the trigger and in between the trigger and the housing (use a cotton-tipped applicator to reach tight or inaccessible areas).
4. Do not spray water or other cleaning liquids directly into the exit window.
5. Wipe the scanner exit window with a lens tissue or other material suitable for cleaning optical material such as eyeglasses.
6. Immediately dry the scanner window after cleaning with a soft, non-abrasive cloth to prevent streaking.
7. Allow the unit to air dry before use.
8. Scanner connectors:
 - a) Dip the cotton portion of a cotton-tipped applicator in isopropyl alcohol.
 - b) Rub the cotton portion of the cotton-tipped applicator back and forth across the connector on the Zebra scanner at least three times, making sure to leave no cotton residue.
 - c) Use the cotton-tipped applicator dipped in alcohol to remove grease and dirt near the connector area.
 - d) Use a dry cotton-tipped applicator and rub the cotton portion back and forth across the connectors at least three times. Do not leave any cotton residue on the connectors.

Troubleshooting

Use this information to troubleshoot the DS4678 scanner.

Table 9 Troubleshooting

Problem	Possible Causes	Possible Solutions
The aiming dot does not appear when pressing the trigger	No power to the digital scanner	If the configuration requires a power supply, re-connect the power supply.

Table 9 Troubleshooting (Continued)

Problem	Possible Causes	Possible Solutions
	Digital scanner is disabled	For IBM 468x and USB IBM hand-held, IBM tabletop, and OPOS modes, enable the digital scanner via the host interface. Otherwise, see the technical person in charge of scanning.
	If using RS-232 Nixdorf B mode, CTSis not asserted	Assert CTS line.
	Aiming pattern is disabled	Enable the aiming pattern. See Handheld Decode Aiming Pattern .
Scanner emits aiming dot but does not decode barcode	Scanner is not programmed for the barcode type	Program the scanner to read that type of barcode. See Symbologies .
	Barcode symbol is unreadable	Scan test barcodes of the same barcode type to determine if the barcode is defaced.
	The aiming dot is placed incorrectly on the barcode	Move the barcode so that the aiming dot is within the field of view.
	Distance between scanner and barcode is incorrect	Move the scanner closer to or further from the barcode.
Scanner decodes barcode but does not transmit data to the host	Scanner is not programmed for the correct host type	Scan the appropriate host type programming barcode. See the information corresponding to the host type.
	Interface cable is loose	Reconnect the cable.
	Cradle is not programmed for the correct host type	Check scanner host parameters to edit options.
	Scanner is not paired to host connected interface	Pair scanner to the cradle by scanning the pairing code on the cradle.
	Cradle has lost connection to the host	<ol style="list-style-type: none"> 1. Disconnect power supply 2. Disconnect host cable 3. Wait three seconds 4. Reconnect host cable 5. Reconnect power supply 6. Reestablish pairing

Table 9 Troubleshooting (Continued)

Problem	Possible Causes	Possible Solutions
	If the scanner emits four long low beeps, a transmission error has occurred. This occurs if a unit is not properly configured or connected to the wrong host type	Set the scanner's communication parameters to match the host's setting.
	If the scanner emits five low beeps, a conversion or format error occurred	Configure the scanner's conversion parameters properly.
	If the scanner emits low/high/low beeps, it detected an invalid ADF rule	Program the correct ADF rules. Refer to the Advanced Data Formatting Programmer Guide.
Host displays scanned data incorrectly	Scanner is not programmed to work with the host	Scan appropriate host type programming barcode.
		For RS-232, set the scanner's communication parameters to match the host settings.
		For a Keyboard Wedge configuration, program the system for the correct keyboard type and turn off the CAPS LOCK key.
		Program the proper editing options (for example, UPC-e to UPC-A Conversion).
Scanner emits short low/high/short medium short high beep sequence (power-up beep sequence) more than once	The USB bus may put the scanner in a state where power to the scanner is cycled on and off more than once	Normal during host reset.
Scanner emits four short high beeps during decode attempt	Scanner has not completed USB initialization	Wait several seconds and scan again.
Scanner emits low/low/low/extra low beeps when not in use	RS-232 receive error	Normal during host reset. Otherwise, set the scanner's RS-232 parity to match the host setting.
Scanner emits low/high beeps during programming	Input error, incorrect barcode or Cancel barcode scanned	Scan the correct numeric barcodes within range for the parameter you are programming.
Scanner emits low/high/low beeps during programming	Out of host parameter storage space	Scan the correct number of barcodes within range for the parameter.
	Out of memory for ADF rules	Reduce the number of ADF rules or the number of steps in the ADF rules.
	During programming, indicates out of ADF parameter storage space	Erase all rules and reprogram with shorter rules.

Table 9 Troubleshooting (Continued)

Problem	Possible Causes	Possible Solutions
Scanner emits a power-up beep after changing USB host type	The USB bus re-established power to the digital scanner	Normal when changing USB host type.
Scanner emits one high beep when not in use	In RS-232 mode, a <BEL> character was received, and Beep on <BEL> option is enabled	Normal when Beep on <BEL> is enabled, and the scanner is in RS-232 mode.
Scanner emits frequent beeps	No power to the scanner	Check the system power. If the configuration requires a power supply, reconnect the power supply.
	Incorrect host interface cable connected	Verify that the correct host interface cable is used. If not, connect the correct host interface cable.
	Interface/power cables are loose	Check for loose cable connections and reconnect cables.
Scanner emits five long low beeps after a barcode is decoded	Conversion or format error detected The scanner conversion parameters are not properly configured	Ensure the scanner conversion parameters are properly configured.
	Conversion or format error detected An ADF rule was set up with characters that cannot be sent for the host selected	Change the ADF rule, or change to a host that can support the ADF rule.
	Conversion or format error detected A barcode was scanned with characters that cannot be sent for that host	Change the barcode or change to a host that can support the barcode.
Scanner LED blinks even if the pairing request was canceled from the remote iOS/Android device	If the passkey entry is canceled from the phone/tablet, the scanner remains in the passkey entry mode for 30 sec before timing out	Exit pass key entry mode. Scan Cancel or scan any other barcode.
Scanner emits four short high beeps, and the scanner LED is red	Battery charge is very low	Insert the scanner into a cradle.
Cradle LED blinks amber rapidly, and the scanner LED is not lit	The cradle is not providing current to the scanner	Ensure the scanner is securely seated in the cradle. If the behavior continues, clean and dry the electrical contacts on the scanner and cradle. Then replace the scanner in the cradle and ensure it sits properly on the base.



NOTE: If the scanner still experiences problems after performing these checks, contact the distributor or call support.

Dumping Scanner Parameters

Scan the following barcode to output all the asset tracking and parameter information from the scanner into a text document when troubleshooting a scanner issue.

It may be necessary to first scan `<DATA> <SUFFIX 1> (1)`



NOTE: If 123Scan is available, use it instead of this feature. 123Scan is the preferred method for reviewing scanner data.

1. Connect the scanner to a host computer and open a text program.

Interface	Text Program
USB HID Keyboard Mode	Windows Notepad or Wordpad
RS-232	Windows HyperTerminal

2. Scan this barcode to initiate the data transfer from the scanner to the host computer.

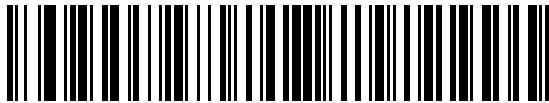

See the parameter numbers to interpret the parameter/attribute numbers in the output.

Send Versions

Use the following barcodes to send the specified information.

Send Software Version

Scan the following barcode to send the version of software installed in the scanner.

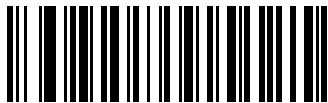

Software Version

Send Serial Number

Scan the following barcode to send the scanner serial number to the host.



Serial Number

Send Manufacturing Information

Scan the following barcode to send the scanner manufacturing information to the host.



Technical Specifications

This section lists the technical specifications of the DS4678 configurations.

- [DS4678-SR](#)
- [DS4678-DPE](#)
- [DS4678-XD](#)

Cradle Signal Descriptions

Cradle pins send specific signals. The following signal descriptions apply to the CR8178-PC and -SC pins and are for reference only.

Cradle to Scanner Signals

Figure 7 Cradle Pin-Outs

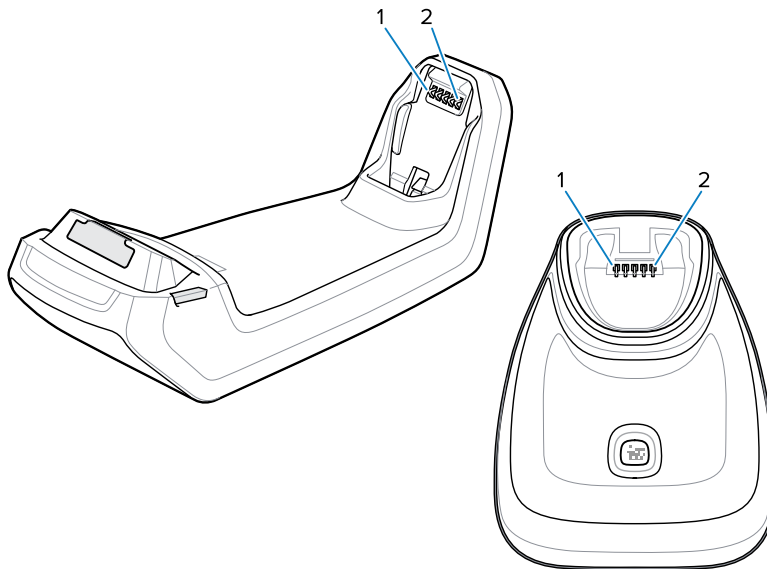

1	Pin 1
2	Pin 5

Table 10 Signal Pin-Outs

Pin	Function
1	PACK+
2	THERM
3	COM1
4	COM2
5	GND

Cradle to Host Signals

Table 11 Pin Host Interface Connectors

Pin	USB	RS-232	Keyboard Wedge	RS-485*
1	CABLE_ID		CABLE_ID	CABLE_ID
2	5 VDC	5 VDC	5 VDC	5 VDC
3	GND	GND	GND	GND
4		TXD	KBD_CLK	IBM_TXD
5	D+	RXD	TERM_DATA	IBM_RXD
6	Short to Pin 1	RTS	KBD_DATA	IBM_DIR
7	D-	CTS	TERM-CLK	
8			1 Meg resistor to pin 1	2 Meg resistor to pin 1
9				
10	12 VDC (optional)	12 VDC (optional)	12 VDC (optional)	12 VDC (optional)
SHELL	Shield	Shield	Shield	Shield

*Additional RS-485 transceiver hardware located within the cable.

Radio Communications

This section provides information about the modes of operation and features available for wireless communication between scanners, cradles, and hosts. The section also includes the parameters necessary to configure the scanner.

The scanner ships with the settings shown in the following table. If the default values suit requirements, programming is not necessary.

Setting Radio Parameters

To set feature values, scan a single barcode or a short barcode sequence. The settings are stored in non-volatile memory and are preserved even when the scanner powers down.



NOTE: Most computer monitors allow scanning barcodes directly on the screen. When scanning from the screen, be sure to set the document magnification to a level where you can see the barcode clearly, and bars and/or spaces do not merge.

If not using the default host, select the host type (see each host section for specific host information) after the power-up beeps sound. This is only necessary upon the first power-up when connected to a new host.

To return all features to default values, scan a barcode in the [Radio Communications Parameter Defaults table](#). Throughout the programming barcode menus, asterisks (*) indicate default values.

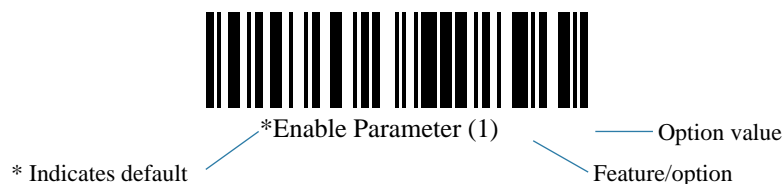

Radio Communications Parameter Defaults

Use this section to navigate to the scanner's radio parameters or to determine its default parameter values.

Table 12 Radio Communication Defaults

Parameter	Parameter Number	SSI Number	Default
Radio Communications Host Types	N/A	N/A	Cradle Bluetooth Classic (Cradle Host)

Radio Communications

Table 12 Radio Communication Defaults (Continued)

Parameter	Parameter Number	SSI Number	Default
Bluetooth Friendly Name	607	F1h 5fh	Scanner name followed by the serial number
Discoverable Mode	670	F1h 62h	General Discoverable Mode
Wi-Fi Friendly Mode	1299	F8h 05h 13h	Disable
Wi-Fi Friendly Channel Exclusion	1297	J8h 05h 11h	Sue All Channels (Standard AFH)
Radio Output Power	1324	N/A	High Power Setting
Link Supervision Timeout	1698	H4h 06h A2h	5 seconds
Bluetooth Radio State	1354	J8h 05h 4Ah	Bluetooth Radio On
Apple iOS Virtual Keyboard Toggle	1114	J8h 04h 5Ah	Disable
Keyboard Keystroke Delay	N/A	N/A	No Delay
Caps Lock Override (Radio)	N/A	N/A	Do Not Override
Barcodes with Unknown Characters (Radio)	N/A	N/A	Send Barcodes With Unknown Characters
Fast HID Keyboard	1361	F8h 05h 51h	Enable
Numeric Keypad Emulation	N/A	N/A	Enable
Quick Keypad Emulation (Radio)	1362	F8h 05h 52h	Enable
Keyboard FN1 Substitution	N/A	N/A	Disable
Function Key Mapping (Radio)	N/A	N/A	Disable
Simulated Caps Lock (Radio)	N/A	N/A	Disable
Convert Case (Radio)	N/A	N/A	No Case Conversion
Beep on Reconnect Attempt	559	F1h F2h	Disable
Reconnect Attempt Interval	558	F1h 2Eh	30 seconds
Auto-reconnect	604	F1h 5Ch	Immediately
Sleep Between Attempts	1778	F8h 06h F2h	1 minute (60 seconds)
Number of Retry Attempts	1779	F8h 0h F3h	Do Not Retry
Modes of Operation	538	J1h A1h	Point-to-Point Mode
Parameter Broadcast (Cradle Host Only)	148	94h	Enable
Pairing Modes	542	F1h 1Eh	Unlocked

Table 12 Radio Communication Defaults (Continued)

Parameter	Parameter Number	SSI Number	Default
Pair on Contacts	545	F1h 21h	Enable
Toggle Pairing	1322	F8h 05h 2Ah	Disable
Connection Maintenance Interval	N/A	N/A	15 Minutes
Page Parameters			
Page Button	746	F1h EAh	Enable
Page Mode	1364	F8h 05h 54h	Page Simple
Page State Timeout	1365	F8h 05h 55h	30 Seconds
Bluetooth Security			
Pin Code	552	F1h 28h	12345
Variable Pin Code	608	F1h 60h	Static
Bluetooth Security Level	1393	F8h 05h 71h	Low
Virtual Tether Parameters			
Configure the Alarm on the Scanner	2053	F8h 08h 05h	Disable
Audio Virtual Tether Alarm on Scanner	2246	F8h 08h C6h	Enable except in Night Mode
LED Virtual Tether Alarm on Scanner	2247	F8h 08h C7h	Enable
Illumination Virtual Tether Alarm on Scanner	2248	F8h 08h C8h	Enable
Haptic Virtual Tether Alarm on Scanner	2249	Fh8 08h C9h	Enable
Virtual Tether Alarm on the Cradle	2124	F8h 4Ch 21h	Disable
Delay Before Virtual Alarm Activates	2054	F8h 08h 06h	30 sec
Virtual Tether Alarm Duration	2055	J8h 08h 07h	5 min
Defeat Virtual Tether Alarm	2119	F8h 08h 47h	Pause Alarm on Trigger Pull/Page Button
Pause Virtual Tether Alarm Duration	2120	F8h 08h 48h	30 sec
General Radio Parameters			
Batch Mode	544	F1h 20h	Normal (Do Not Batch Data)
Beep on Insertion	288	F0h 20h	Enable
Bluetooth SPP Beep on <BEL>	150	96h	Enable

Wireless Beeper Definitions

The definitions lists beep sequences that occur during pairing operations.

Table 13 Wireless Beeper Definitions

Beeper Sequence	Indication
High/low/high/low beeps	Pairing barcode scanned.
Short low/high beeps	Scanner paired with the cradle.
Short high/low beeps	Scanner unpaired with the cradle.  NOTE: When connected to a remote device using SPP or HID, if a disconnect beep sequence sounds immediately after scanning a barcode, check the host device to determine if it received the transmitted data. The scanner may have transmitted the last barcode scanned after losing the connection.
Long low long/high beeps	Unsuccessful pairing attempt. See Auto-reconnect Parameters .
Long low/long high/long low/ long high beeps	Remote device rejected the connection attempt, possibly due to an attempt to pair with a cradle that is already paired with the maximum number of scanners.
Long high beeps.	The Audio Virtual Tether alarm on scanner is enabled.
Four long low beeps	A transmission error occurred and the data is ignored, due to an improperly configured scanner. Check option setting.
	During cradle communication, the scanner did not receive acknowledgment of data receipt from the cradle. However, the host may have received the data. Check the host for receipt of the data, and re-scan the barcode if it was not received.
Five high beeps	Emitted every five seconds during a reconnection attempt. See Auto-reconnect Parameters .

Radio Communications Host Types

Each host type has Bluetooth Classic and Bluetooth Low Energy options.

Bluetooth Low Energy has better Wi-Fi coexistence, as advertising and connection is performed outside of Wi-Fi channels 1, 6, and 11 (2402, 2426, 2480 MHz). Due to its smaller data rate, Bluetooth Low Energy is up to 7 times slower than Bluetooth Classic (0.27 Mbps versus 0.7-2.1 Mbps), and data-intensive activities such as firmware updates can take significantly longer.

Cradle

Select this host type when connecting a scanner to a communication cradle.



NOTE: The scanner automatically tries to reconnect to a remote device upon a disconnection due to the radio losing communication. See [Auto-reconnect Parameters](#) for more information.

Scan the pairing barcode on the cradle or place the scanner in the cradle to establish a connection.

Scan the barcode below to enable cradle connection mode.

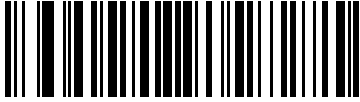

Cradle Bluetooth Classic

Keyboard Emulation (HID)

Select this host type when connecting to a PC/tablet/phone emulating a Bluetooth keyboard.

HID Bluetooth Classic

This enables the host and scanner to communicate using the Human Interface Device (HID) Keyboard Profile over Bluetooth Classic radio. The scanner(s) support Discoverable (Peripheral) and Non-Discoverable (Central) mode.

To establish a connection (initial setup only), select `HID Bluetooth Classic` and connect to Central or Peripheral mode:

- Central mode - Scan a pairing barcode with the MAC address of the host device.
- Peripheral mode - From the host, discover Bluetooth devices and select the scanner from the discovered device list.



HID Bluetooth Classic

HID Bluetooth Low Energy (Discoverable)

This enables the host to establish an HID (Human Interface Device) Keyboard Profile connection with the scanner over a Bluetooth Low Energy radio. The scanner is discoverable (Peripheral mode).

To establish a connection (initial setup only), choose the `HID Bluetooth Low Energy (Discoverable)` option. From the host, discover Bluetooth devices and select the scanner from the discovered device list.



HID Bluetooth Low Energy (Discoverable)

Simple Serial Interface (SSI)

Select this host type when connecting to a Zebra mobile device or PC/tablet/phone running a Zebra scanner SDK app.

SSI Bluetooth Classic (Non-discoverable)

This enables the scanner(s) to establish a connection with a Zebra mobile computer over a Bluetooth Classic radio. The scanner is not discoverable (Central mode).

To establish a connection (initial setup only), choose the SSI BT Classic (Non-discoverable) option, and then scan a pairing barcode with the host device's MAC address.



NOTE: Additional steps may be necessary depending on host's Bluetooth stack.

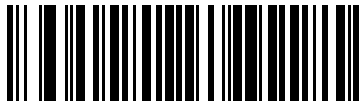

SSI Bluetooth Classic (Non-discoverable)

SSI Bluetooth Classic (Discoverable)

This enables communication with Scanner SDK for Android generated apps, and allows the host to establish a connection with the scanner over Bluetooth Classic radio. The scanner is discoverable (Peripheral mode).

To establish a connection (initial setup only), choose the SSI Bluetooth Classic (Discoverable) option. From the host, discover Bluetooth devices and select the scanner from the discovered device list.

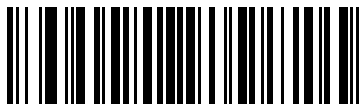

SSI Bluetooth Classic (Discoverable)

SSI Bluetooth Low Energy

This enables communication with Scanner SDK for iOS generated apps, and allows the host to establish a connection with the scanner over Bluetooth Low Energy radio. The scanner is discoverable (Peripheral mode).

To establish a connection (initial setup only), choose the SSI Bluetooth Low Energy option. From the host application, select the scanner from the discovered device list.

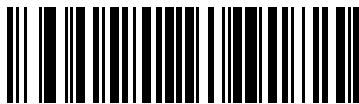

SSI Bluetooth Low Energy

Serial Port Profile (SPP)

Select this host type when connecting to a PC/tablet/phone using a Bluetooth serial connection.

SPP BT Classic (Non-discoverable)

This enables the scanner to establish an SPP connection with the host over Bluetooth Classic radio. The scanner is not discoverable (Central mode).

To establish a connection (initial setup only), choose the SPP BT Classic (Non-discoverable) option, and then scan a pairing barcode with the MAC address of the host device.

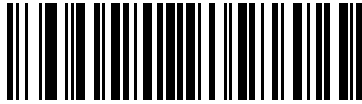

SPP Bluetooth Classic (Non-discoverable)

SPP BT Classic (Discoverable)

This enables the host to establish an SPP connection with the scanner over Bluetooth Classic radio. The scanner is discoverable (Peripheral mode).

To establish a connection (initial setup only), choose the SPP BT Classic (Discoverable) option. From the host, discover Bluetooth devices and select the scanner from the discovered device list.



SPP Bluetooth Classic (Discoverable)

Bluetooth Technology Profile Support

With Bluetooth Technology Profile Support, the scanner communicates directly to the host using Bluetooth technology and does not require the cradle. The scanner supports standard Bluetooth Serial Port Profile (SPP) and HID profiles which enable communication with other Bluetooth devices that support these profiles.

- SPP - The scanner connects to the PC/host via Bluetooth and behaves as if there is a serial connection.
- HID - The scanner connects to the PC/host via Bluetooth and behaves as a keyboard.

Central/Peripheral Modes

The scanner can be set up as Central or Peripheral mode.

When the scanner is set up as Peripheral mode, it is discoverable and connectible to other devices. When the scanner is set up as Central mode, the Bluetooth address of the remote device to which a connection is requested is required. A pairing option with the remote device address must be created and paired to attempt a connection to the remote device. See [Pairing Barcode Format Using the Scan-To-Connect \(STC\) Utility](#).

Central Mode

Setting up the scanner as a Central (SPP) requires the Bluetooth address of the remote (Peripheral) device to which the scanner is connecting.

Create and choose a pairing barcode with the remote device address to connect to the remote device. See [Pairing Barcode Format Using the Scan-To-Connect \(STC\) Utility](#).

Peripheral Mode

If you set up the scanner as Peripheral mode (SPP or HID), it is discoverable and accepts an incoming connection request from a remote device.



NOTE: The number of scanners depends on host capability.

Bluetooth Friendly Name

Parameter # 607 (SSI # F1h 5fh)

You can set a meaningful name for the scanner that appears in the application during device discovery.

By default this is the scanner family name followed by the serial number, such as DS3578123456789ABCDEF. Select `Set Defaults` to revert the scanner to this name; use custom defaults to maintain the user-programmed name through a `Set Defaults` operation.



NOTE: If the application allows setting a device name, this takes precedence over the Bluetooth Friendly Name.

To create a Bluetooth Friendly Name, choose Bluetooth Friendly Name, and then scan up to 23 characters from [Alphanumeric Barcodes](#). If the name contains less than 23 characters, scan the [End of Message](#) barcode after entering the name.

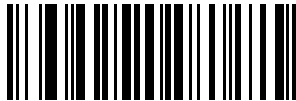

Bluetooth Friendly Name

Discoverable Mode

Parameter # 610 (SSI # F1h 62h)

Select a discoverable mode based on the device initiating discovery.

- General Discoverable Mode - The host initiates the connection.
- Limited Discoverable Mode - A mobile device initiates connection, and the device does not appear in General Discoverable Mode. Note that it can take longer to discover the device in this mode. The device remains in Limited Discoverable Mode for 30 seconds, and green LEDs flash. After 30 seconds, it is non-discoverable. To re-activate Limited Discoverable Mode, press the trigger.



*General Discoverable Mode (0)

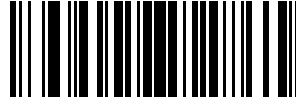

Limited Discoverable Mode (1)

Wi-Fi Friendly Options

You can set Wi-Fi friendly options.

Wi-Fi Friendly Mode

Parameter # 1299 (SSI # F8h 05h 13h)

Scanners are configurable for Wi-Fi friendly mode.

Choose an option to enable or disable Wi-Fi Friendly Mode, and then see [Wi-Fi Channel Exclusion](#) to select any channels to exclude.

When using this feature, configure all scanners in the area for Wi-Fi friendly mode. By default, no Wi-Fi channels are excluded. Since Bluetooth requires a minimum of 20 channels when Wi-Fi channels 1, 6, and 11 are excluded, a smaller number of channels are cut from the hopping sequence. Updating Wi-Fi friendly settings before Bluetooth connection is recommended.



NOTE: The scanner remains in sniff mode, and exits sniff mode only during firmware update. If a Wi-Fi channel is excluded from the hopping sequence, AFH turns off. Scanner (and cradle) avoid the selected Wi-Fi channels after establishing connection.



Enable Wi-Fi Friendly Mode (1)



*Disable Wi-Fi Friendly Mode (0)

Wi-Fi Friendly Channel Exclusion

Parameter # 1297 (SSI # F8h 05h 11h)

You can set channels to exclude.

- Exclude Wi-Fi channel 1 - Bluetooth channels 0-21 are excluded from the hopping sequence (2402-2423 MHz).
- Exclude Wi-Fi channel 6 - Bluetooth channels 25-46 are excluded from the hopping sequence (2427 - 2448 MHz).
- Exclude Wi-Fi channel 11 - Bluetooth channels 50-71 are excluded from the hopping sequence (2452 - 2473 MHz).

Radio Communications

- Exclude Wi-Fi channel 1, 6 and 11 - Bluetooth channels 2-19 (2404-2421 MHz), 26-45 (2428 - 2447 MHz), and 51-69 (2453 - 2471 MHz) are excluded from the hopping sequence.
- Exclude Wi-Fi channels 1 and 6 - Bluetooth channels 0-21 (2402-2423 MHz) and 25-46 (2427 - 2448 MHz) are excluded from the hopping sequence.
- Exclude Wi-Fi channels 1 and 11 - Bluetooth channels 0-21 (2402-2423 MHz) and 50-71 (2452 - 2473 MHz) are excluded from the hopping sequence.
- Exclude Wi-Fi channel 6 and 11 - Bluetooth channels 25-46 (2427 - 2448 MHz) and 50-71 (2452 - 2473 MHz) are excluded from the hopping sequence.
- Use All Channels (Standard AFH) - Sets all channels to use.

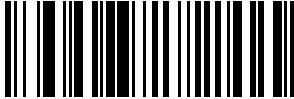

*Use All Channels (Standard AFH) (0)

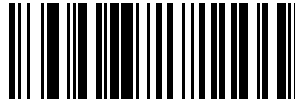

Exclude Wi-Fi Channel 1 (1)



Exclude Wi-Fi Channel 6 (2)



Exclude Wi-Fi Channel 11 (3)



Exclude Wi-Fi Channels 1, 6, and 11 (4)



Exclude Wi-Fi Channels 1 and 6 (5)



Exclude Wi-Fi Channels 1 and 11 (6)



Exclude Wi-Fi Channels 6 and 11 (7)

Bluetooth Radio Parameters

You can set Bluetooth timeout settings, radio power, radio state, and wait for connection options.

Radio Output Power

Parameter # 1324

The scanner uses a configurable radio which can be configured to operate in:

- Low power mode as a Class 2 device.
- High power mode as Class 1 device.

Increase the radio output power to increase range. Scan a barcode to select the desired power mode.



Very Low Power (3)



Low Power (2)

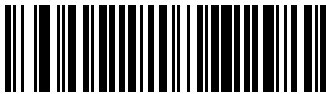

Medium Power (1)



*High Power (0)

Link Supervision Timeout

Parameter # 1698 (SSI # F4h 06h A2h)

Select a time interval to set how quickly the scanner senses that the Bluetooth radio loses connection to the remote device.

A lower value minimizes data loss at the edge of the operating range, while a larger value minimizes disconnects due to the remote device not responding in time. If you are experiencing occasional disconnects and the scanner is able to reconnect, increase the link supervision timeout value.



NOTE: The scanner only controls Link Supervision Timeout in Central mode.



0.5 Seconds (800)



2 Seconds (3200)

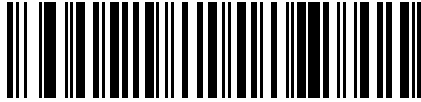

*5 Seconds (8000)

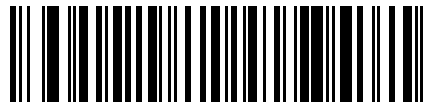

10 Seconds (16000)

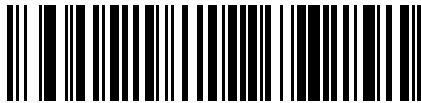

20 Seconds (32000)

Bluetooth Radio State

Parameter # 1354 (SSI # F8h 05h 4Ah)

You can turn the Bluetooth radio on or off.

- On - the bluetooth radio is on.
- Off - the bluetooth radio is off.



NOTE: When the radio is turned off on the cradle, turn it on again using host parameter control.

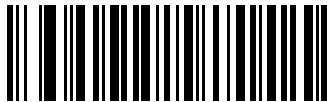

*Bluetooth Radio On (1)

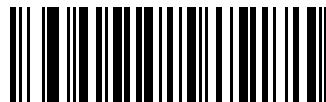

Bluetooth Radio Off (0)

HID Host Parameters

The scanner supports virtual keyboard emulation for the Apple iOS, and keyboard emulation over the Bluetooth HID profile. In this mode the scanner can interact with Bluetooth enabled hosts supporting the HID profile as a Bluetooth keyboard. Scanned data is transmitted to the host as keystrokes.

Apple iOS Virtual Keyboard Toggle

Parameter # 1114 (SSI # F8h 04h 5Ah)



NOTE: When this feature is enabled, the scanner may be incompatible with non-Apple iOS devices.



Enable Apple iOS Virtual Keyboard Toggle (1)

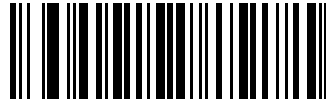

*Disable Apple iOS Virtual Keyboard Toggle (0)

Keyboard Keystroke Delay

This parameter sets the delay, in milliseconds, between emulated keystrokes. Select one of the following barcodes to increase the delay when the HID host requires slower data transmission.

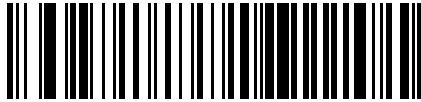

*No Delay (0 msec)



Medium Delay (20 msec)



Long Delay (40 msec)

Caps Lock Override (Radio)

Select `Override Caps Lock Key` to preserve the case of the data regardless of the state of the Caps Lock key.



NOTE: This setting is always enabled for the **Japanese, Windows (ASCII)** keyboard type and cannot be disabled.

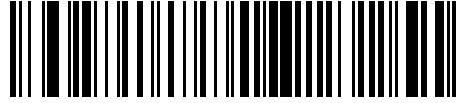

Override Caps Lock Key (Enable)

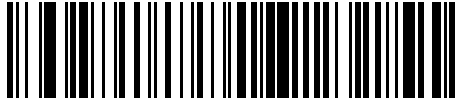

*Do Not Override Caps Lock Key (Disable)

Barcodes with Unknown Characters (Radio)

You can send all barcode data except for unknown characters. The scanner issues no error beeps.

This option applies only to the HID Keyboard Emulation device and IBM device. Unknown characters are characters the host does not recognize.

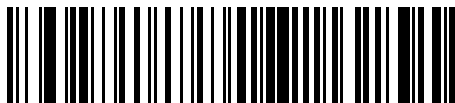

*Send Barcodes With Unknown Characters

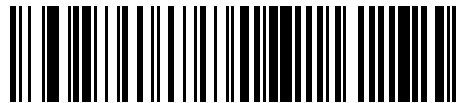

Do Not Send Barcodes With Unknown Characters

Fast HID Keyboard

Parameter # 1361 (SSI # F8h 05h 51h)

You can set this parameter to transmit Bluetooth HID keyboard data at a faster rate.



*Enable Fast HID Keyboard (1)



Disable Fast HID Keyboard (0)

Numeric Keypad Emulation

You can send all characters as ASCII sequences over the numeric keypad.

For example, ASCII A transmits as “ALT make” 0 6 5 “ALT Break”.

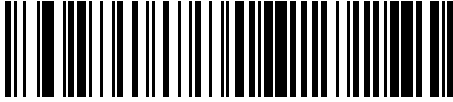

*Enable Numeric Keypad Emulation



Disable Numeric Keypad Emulation

Quick Keypad Emulation (Radio)

Parameter # 1362 (SSI # F8h 05h 52h)

You can set a quicker method of emulation using the numeric keypad where ASCII sequences are only sent for ASCII characters not found on the keyboard.



NOTE: This option applies only to the HID keyboard emulation device when [Keyboard Emulation \(HID\)](#) is enabled.

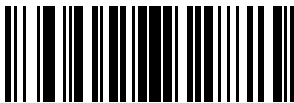

*Enable Quick Keypad Emulation (1)



Disable Quick Keypad Emulation (0)

Keyboard FN1 Substitution

You can replace the FN1 character in an EAN-128 barcode with a user-selected Key Category and value. See [FN1 Substitution Values](#) to set the Key Category and Key Value.

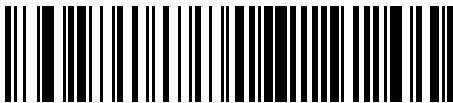

Enable Keyboard FN1 Substitution

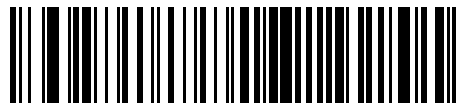

*Disable Keyboard FN1 Substitution

Function Key Mapping (Radio)

You can map the keys in bold listed in [ASCII Character Sets](#) in place of the standard key mapping.

ASCII values under 32 are normally sent as control-key sequences. Keys that do not have a bold entry remain the same regardless of this parameter setting.



Enable Function Key Mapping



*Disable Function Key Mapping

Simulated Caps Lock (Radio)

You can set **Simulate Caps Lock** to invert upper and lower case characters as if the Caps Lock state is enabled on the keyboard.

- Enable - simulates Caps Lock state on keyboard.
- Disabled - does not simulate Caps Lock state on keyboard.

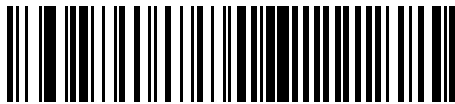

Enable Simulated Caps Lock

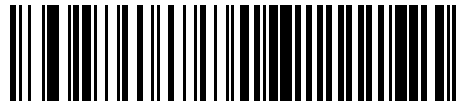

*Disable Simulated Caps Lock

Convert Case (Radio)

Select an option to convert all data to the selected case.

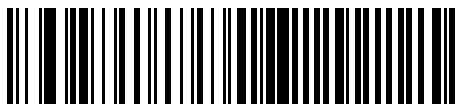

*No Case Conversion

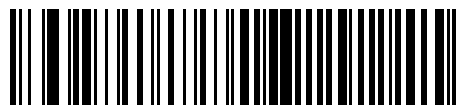

Convert All to Upper Case

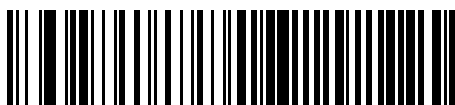

Convert All to Lower Case

Auto-reconnect Parameters

When in SPP Central, Cradle Host mode, or for Bluetooth Keyboard Emulation, the scanner automatically tries to reconnect to a remote device when it disconnects due to losing radio communication.

This occurs if the scanner moves out of range of the remote device, or if the remote device powers down. The scanner tries to reconnect for the period of time specified by the [Reconnect Attempt Interval](#) setting. During that time the green LED blinks.

If auto-reconnect fails due to page timeouts, the scanner lights the red LED, the scanner sounds a page timeout beep (long low/long high), and enters low power mode. To restart the auto-reconnect process, pull the scanner trigger.

If auto-reconnect fails because the remote device rejects the connection attempt, the scanner sounds a connection reject beep sequence (see [Wireless Beeper Definitions](#)) and deletes the remote pairing address. Scan a pairing barcode to attempt a new connection to the remote device.



NOTE: If you scan a barcode during the auto-reconnect sequence, a transmission error beep sequence sounds and the data does not transmit to the host. After re-connection, normal scanning operation returns. For error beep sequence definitions, see [Wireless Beeper Definitions](#).

The scanner has memory available for storing a remote Bluetooth address for each Central mode (SPP, Cradle). When switching between modes, the scanner automatically tries to reconnect to the last connected device in that mode.



NOTE: Scanning a [Radio Communications Host Type](#) to select another Bluetooth host resets the radio which disables scanning. It takes several seconds for the scanner to re-initialize the radio and enable scanning.

Beep on Reconnect Attempt

Parameter # 559 (SSI # F1h F2h)

You can enable audio feedback during a reconnect attempt.

When the scanner disconnects as it moves out of range, it immediately attempts to reconnect. During this time, the green LED blinks. If auto-reconnect fails, the scanner emits a page timeout beep (long low/long high) and the LED stops blinking. Restart the process by pulling the trigger.

- Enabled - the scanner emits 5 short high beeps every 5 seconds during the reconnection attempt, providing an out of range indicator.
- Disabled - the scanner does not emit sound during reconnection attempt.



NOTE: To extend the time the scanner attempts to reconnect, see [Reconnect Attempt Interval](#)



Enable Beep on Reconnect Attempt (1)

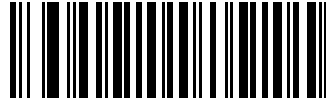

*Disable Beep on Reconnect Attempt (0)

Reconnect Attempt Interval

Parameter # 558 (SSI # F1h 2Eh)

You can change this time interval after a scanner disconnects as it moves out of range and then tries to reconnect.



*Attempt to Reconnect for 30 Seconds (6)

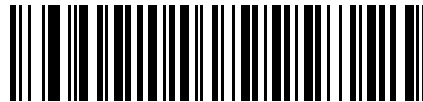

Attempt to Reconnect for 1 Minute (12)



Attempt to Reconnect for 5 Minutes (60)



Attempt to Reconnect for 30 Minutes (360)



Attempt to Reconnect for 1 Hour (720)



Attempt to Reconnect Indefinitely (0)

Auto-reconnect

Parameter # 604 (SSI # F1h 5Ch)

You can select a reconnect option for the scanner when it disconnects from a remote device:

- Auto-reconnect on Barcode Data - The scanner auto-reconnects when you scan a barcode. A delay can occur when transmitting the first characters. The scanner sounds a decode beep upon barcode scan,

followed by a connection, a page timeout, a rejection beep, or a transmission error beep. This option optimizes battery life on the scanner and mobile device. Note that auto-reconnect does not occur on rejection and cable unplug commands.

- Auto-reconnect Immediately - When the scanner loses connection, it attempts to reconnect. If a page timeout occurs, the scanner attempts reconnect on a trigger pull. Select this option if the scanner's battery life is not an issue and you do not want a delay when transmitting the first barcode.



NOTE: Auto-reconnect does not occur on rejection and cable unplug commands.

- Disable Auto-reconnect - When the scanner loses connection, you must re-establish it manually.

Auto-reconnect applies to the following hosts:

- Cradle Bluetooth Classic
- Cradle Bluetooth Low Energy
- HID Bluetooth Classic
- SSI Bluetooth Classic (Non-discoverable)
- SPP Bluetooth Classic (Non-discoverable)

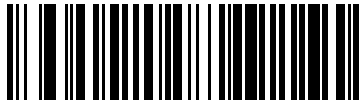

Auto-reconnect on Barcode Data (1)

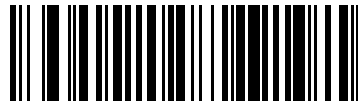

*Auto-reconnect Immediately (2)

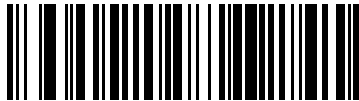

Disable Auto-reconnect (0)

Sleep Between Attempts

Parameter # 1778 (SSI # F8h 06h F2h)

You can reduce the potential Wi-Fi interference and extend the scanner battery life by enabling the scanner to go to sleep (low power mode) for the time indicated between reconnect attempts.



NOTE: This feature only works when low power mode is enabled on the scanner and when the scanner is not charging in the cradle.

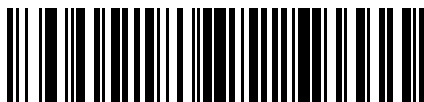

Sleep for 30 Seconds (30)

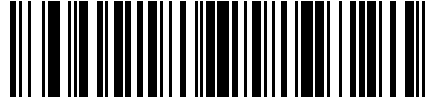

*Sleep for 1 minute (60)



Sleep for 2 minutes (120)

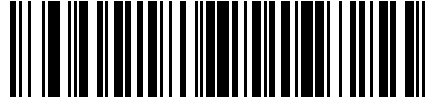

Sleep for 5 minutes (300)

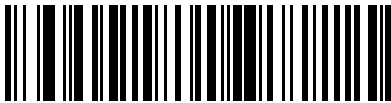

Sleep for 30 minutes (1800)

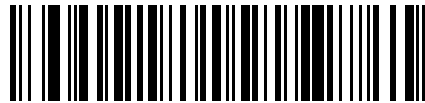

Sleep for 1 hour (3600)

Number of Retry Attempts

Parameter # 1779 (SSI # F8h 0h F3h)

You can control how many reconnect and associated sleep attempts to execute. After the number of retries is reached, the scanner no longer attempts to reconnect to the host.



NOTE: After the retry period expires, if the trigger is pulled, the scanner restarts the auto-reconnect and sleep sequence.

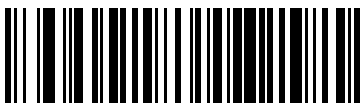

*Do Not Retry (0)

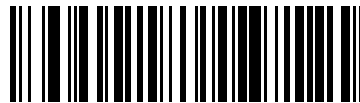

Retry 5 Times (5)



Retry 10 Times (10)

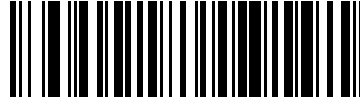

Retry 20 Times (20)



Retry 40 Times (40)

Scanner(s) to Cradle Support

You can set different options to pair, unpair, and set different cradle preferences for a scanner.

Modes of Operation

Parameter # 538 (SSI # F1h A1h)

The charging cradle with radio supports two radio communication modes of scanner operation for wireless communication.

Select a mode of operation:

- **Point-to-Point** - Only one scanner can connect to the cradle at a time. Pair the scanner to the cradle either by inserting it into the cradle (if [Pair on Contacts](#) is enabled), or by scanning the PAIR barcode on the cradle. Communication can be locked, unlocked (default), or in a lock override state (see [Pairing Modes](#)). In locked mode, you must set a [Connection Maintenance Interval](#) to set the locking interval.
- **Multipoint-to-Point** - Pair up to seven scanners to one cradle. To set this mode, scan the Multipoint-to-Point barcode using the first scanner to connect to the cradle. See [Parameter Broadcast \(Cradle Host Only\)](#) to clone all scanners paired to the cradle after programming the first.

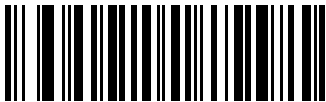

*Point-to-Point Mode (0)

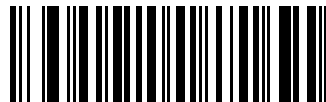

Multipoint-to-Point Mode (1)

Parameter Broadcast (Cradle Host Only)

Parameter # 148 (SSI # 94h)

When in Multipoint-to-Point mode, you can enable `Parameter Broadcast` to broadcast all parameter barcodes scanned to all other connected scanners.

If disabled, only the individual scanner processes parameter barcodes and the scanner ignores parameters broadcast from other scanners or from the cradle.

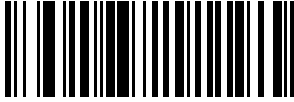

*Enable Parameter Broadcast (1)



Disable Parameter Broadcast (0)

Pairing

Pairing is the process by which a scanner initiates communication with a cradle.

Scanning Multipoint-to-Point activates multi-scanner-to-cradle operation and allows up to seven scanners to pair.

To pair the scanner with the cradle, scan the pairing barcode on the cradle. The scanner emits a high/low/high/low beep sequence to indicate that it decoded the pairing barcode and then a low/high beep when it establishes a connection with the cradle.



NOTE: Each cradle uses a unique pairing barcode. Do not scan data or parameters until pairing completes. When the scanner pairs with the cradle in SPP Central or Cradle Host mode, it attempts to reconnect to a remote device upon a disconnection due to the radio losing communication. For more information, see [Auto Reconnect Parameters](#).

Pairing Modes

Parameter # 542 (SSI # F1h 1Eh)

The cradle and scanner support two modes of pairing.

- **Unlocked Pairing Mode** - In Point-to-Point mode only, pair (connect) a new scanner to a cradle at any time by either scanning the PAIR barcode on the cradle or by inserting it into the cradle with [Pair on Contacts](#) enabled. This unpairs the previously connected scanner from the cradle.
- **Locked Pairing Mode** - When a cradle is paired (connected) to a scanner (or up to seven scanners in Multipoint-to-Point mode), it rejects any attempt to connect a different scanner. In this mode, you must set a [Pair on Contacts](#).

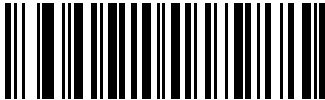

*Unlocked Pairing Mode (0)

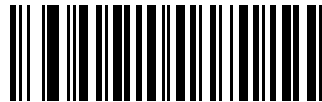

Locked Pairing Mode (1)

Lock Override

Lock Override overrides a locked scanner base pairing and connects a new scanner. In Multipoint-to-Point mode, this unpairs any disconnected (out of range) scanner first to connect the new scanner.

To use Lock Override, scan Lock Override and then pair the scanner.



NOTE: Lock Override is applicable in Point-to-Point mode only (it does not work on scanners in Multipoint-to-Point mode). If seven scanners are connected to a cradle/host device, disconnect them manually before connecting a new scanner.



Lock Override

Pair on Contacts

Parameter # 545 (SSI # F1h 21h)

This parameter pairs the scanner and cradle when you insert the scanner in the cradle. You do not need to scan the pairing barcode on the cradle.

Choose the following:

- Enabled - Scanner pairs on contact and If pairing is successful, the scanner emits a low/high connection beep sequence.
- Disabled - Scanner does not pair on contact.

See [Wireless Beeper Definitions](#) for other beep sequences.

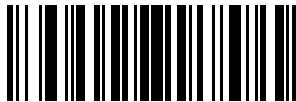

*Enable Pair On Contacts (1)



Disable Pair on Contacts (0)

Pull Trigger Twice to Re-connect

Upon a double trigger press, the scanner attempts to connect to the last known address.

This feature differs from [Auto-reconnect](#) in that the scanner attempts connection only once and keeps the address even on commanded disconnect. The last known address is only cleared upon a reject or with a new successful connection. The address persists over scanner reboot. This feature does not interfere with a double trigger press to open or close an iOS keypad in HID mode.



NOTE: This feature only applies to hosts capable of a commanded connection; SPP Peripheral mode and HID BLE hosts do not support this feature.

Unpairing

Choose Unpair to unpair the scanner, to make the host available for pairing with another scanner.

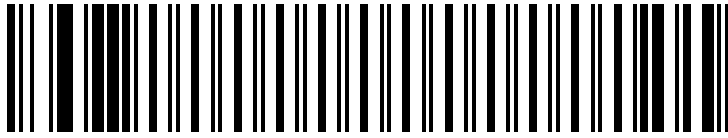

Unpair

Toggle Pairing

Parameter # 1322 (SSI # F8h 05h 2Ah)

The parameter enables a scanner to switch between being paired to a cradle or host (for example, VC80) to being unpaired from the scanner upon toggle.

Choose the following:

- Enabled - Scanner toggles between being paired and unpaired.
- Disabled - Scanner does not switch pairing on toggle.

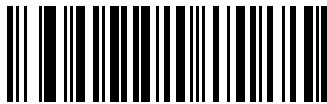

Enable Toggle Pairing (1)

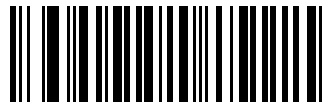

*Disable Toggle Pairing (0)

Pairing Barcode Format Using the Scan-To-Connect (STC) Utility

You can use the STC utility to create a pairing barcode in one step by connecting the Zebra Bluetooth scanner to a phone, tablet, or PC by scanning an STC barcode.

The STC utility is available as a standalone utility. Supported operating systems include Windows and Android.

For more information, go to zebra.com/scantoconnect. Source code is also available for easy app integration.

Connection Maintenance Interval

Parameter # 5002

You can set a time period for a scanner to reconnect to a cradle.



NOTE: The Connection Maintenance Interval only applies in locked pairing mode (see [Pairing Modes](#)).

When a scanner disconnects from a cradle due to a , it attempts to reconnect to the cradle for 30 seconds. If auto-reconnect fails, pull the scanner trigger to restart it.

To ensure that a disconnected scanner can reconnect when it moves back in range, the cradle reserves the connection for that scanner for a period of time defined by the Connection Maintenance Interval. To connect another scanner, either wait until this interval expires and then scan the PAIR barcode on the cradle, or scan [Lock Override](#) with the new scanner and then scan the PAIR barcode on the cradle.



NOTE: When the cradle is paired to the maximum number of scanners, it stores the remote pairing address of each scanner in memory regardless of the scanner condition (e.g., discharged battery). To change the scanners paired to the cradle, select [Unpairing](#) to unpair each connected scanner, and then scan the PAIR barcode on the cradle with each new scanner.

A shorter Connection Maintenance Interval allows new users to gain access to abandoned connections more quickly, but causes problems for users who leave the work area and return. A longer interval allows existing users to leave the work area for longer periods of time, but ties up the system for new users. To avoid this conflict, users who are going off-shift can scan [Toggle Pairing](#) to make the connection immediately available.

Setting the Connection Maintenance Interval

To set the Connection Maintenance Interval, choose one of the following options.

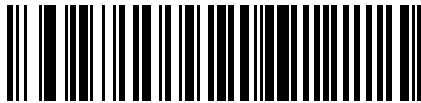

*15 Minutes (0)



30 Minutes (1)

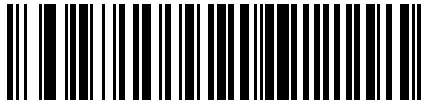

60 Minutes (2)

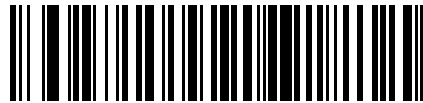

2 Hours (3)

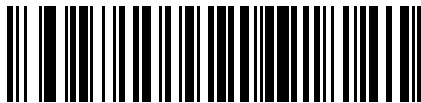

4 Hours (4)



8 Hours (5)



24 Hours (6)



Indefinite (7)

Page Parameters

You can set page button, page mode, and page state timeout options.

Page Button

Parameter # 746 (SSI # F1h EAh)

This parameter enables a cradle with a page button to cause paired scanners to emit a beep sequence when the page button is touched.

Choose the following:

- Enabled - Touching the page button causes a paired scanner to beep.
- Disabled - Touching the page button does not cause a paired scanner to beep.

To use the page button, press the button  for approximately one second. The cradle LED turns blue when the scanner is out of the cradle. The paired scanner beeps five times. If multiple scanners are paired to the cradle, all scanners beep five times.



NOTE: Scanners out of radio range do not beep when paged. For radio range information, refer to Technical Specifications.



*Enable Page Button (1)

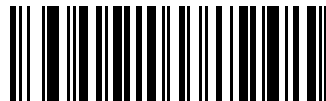

Disable Page Button (0)

Page Mode

Parameter # 1364 (SSI # F8h 05h 54h)

The cradle and scanner support two page modes, Page State and Page Simple.

- Page State - The cradle sends a page state request to each scanner. It remains in this state until every scanner sends an acknowledgment. The scanner enters Page State when the LED indicator blinks blue

and the vibrator and beeper are enabled. When you press the trigger, insert the scanner into the cradle, or the [Page State Timeout](#) expires, the scanner sends the acknowledgment to the cradle and returns to normal state.

- Page Simple - The cradle sends a page indication request to each scanner, and returns to idle state. Each scanner issues a single Page State indication.



Page State (1)

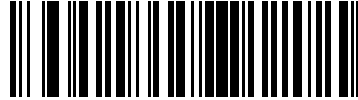

*Page Simple (0)

Page State Timeout

Parameter # 1365 (SSI # F8h 05h 55h)

This parameter enables you to set a page timeout.

The Page State Timeout is programmable in 1 second increments from 1 to 99 seconds.



NOTE: Page State Timeout only applies to Page State mode.

To set a page timeout, choose Page State Timeout, and then enter the two numeric barcodes from [Numeric Barcodes](#) that correspond to the desired timeout duration. Enter a leading zero for single digit numbers.

For example, to set a 5 second page timeout, enter 0 barcode and then 5. To correct an error or change the selection, [Cancel](#).

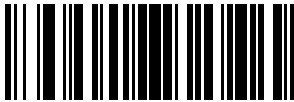

Page State Timeout

Bluetooth Security

The scanner supports Bluetooth authentication. Either the remote device or the scanner can request authentication.

PIN Code

Parameter # 552 (SSI # F1h 28h)

You can use a PIN code with a scanner.

If the scanner communicates with a host with enabled authentication/encryption, the PIN codes on the scanner and host must match, otherwise, pairing fails. To do this, connect the scanner to the host when

setting the PIN code; otherwise, the new PIN code only takes effect on the scanner. The default PIN code is 12345.



NOTE: An extended 16-character PIN code is available for additional security with Open Bluetooth (SPP and HID).

Setting the PIN Code

Set the PIN code (password) on the scanner to connect to the host.

1. Scan the Set & Store PIN Code barcode.

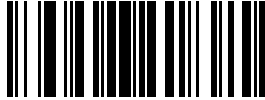

Set & Store PIN Code

2. Scan five barcodes from [Alphanumeric Barcodes](#).
3. Scan [Alphanumeric Barcodes](#).

Variable PIN Code

Parameter # 608 (SSI # F1h 60h)

In Cradle Host mode with authentication enabled, select the default **Static PIN Code** to use the PIN stored in memory rather than requiring manual entry.



NOTE: Only devices using Bluetooth 2.0 or earlier support Variable PIN Code. Do not use this to connect to cradles or devices using Bluetooth 2.1 or later.

The default PIN code is the **Set & Store PIN Code** set previously. Typically, however, HID devices require entering a variable PIN code with each connection.

Entering the Variable PIN Code

When attempting connection, if the device application presents a PIN:

1. Scan Variable PIN Code.
2. Re-attempt connection.
The scanner emits a beep indicating it is waiting for an alphanumeric entry.
3. Enter the application-provided PIN using the [Alphanumeric Barcodes](#).
4. Scan [Alphanumeric Barcodes](#) if the code is less than 16 characters.



*Static PIN Code (0)



Variable PIN Code (1)

The scanner discards the variable PIN code after connection.

Bluetooth Security Level

Parameter # 1393 (SSI # F8h 05h 71h)

This parameter sets a Bluetooth security level.

Choose one of the following options:

- *Low - This is designed for ease of connection with most devices. Some devices may not accept this setting. If connection fails, increase this security setting and try again. If connecting to a Bluetooth 2.1 or later device, this setting uses the “just works” method for secure and simple pairing.



NOTE: Data is encrypted using the Low-security setting if connected to Bluetooth 2.1 or later device.

- Medium - This may require entering a PIN code on the initial connection to pair the scanner and device. If connecting to a Bluetooth 2.1 or later device, this setting uses the “passkey entry” method for secure and simple pairing.
- High - This enables “man in the middle” protection for Bluetooth 2.1 and later. Not all devices support this mode.
- Legacy (Bluetooth 2.0 and earlier) - This enables authentication and encryption for legacy pairing.



*Low (0)

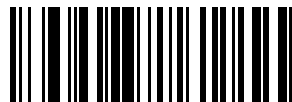

Medium (1)



High (2)

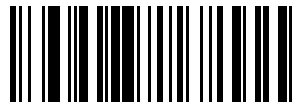

Legacy (3)

Virtual Tether

The Virtual Tether feature enables the scanner, cradle or host application to alert users when Bluetooth connection is lost.

It works by independently controlling the scanner's illumination, audio, haptics and LEDs. To adjust the range of the scanner and cradle connection, change the radio power (high, medium, low). See [Radio Output Power](#) for more information.

Configure the Alarm on the Scanner

Parameter # 2053 (SSI # F8h 08h 05h)

This parameter enables the Virtual Tether alarm on the scanner.

Depending on the device, a Virtual Tether alarm can include audio, LED, illumination, and haptic. Each alarm type can be chosen, allowing for creation of custom alarms. If the scanner is in [Night Mode](#) the Audio beeper does not sound. The scanner vibrates when the alarm activates.

Choose the following:

- Enabled - A Virtual Tether alarm can be set on the scanner.
- Disabled - A Virtual Tether alarm cannot be set on the scanner.

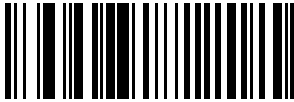

*Disable Virtual Tether Alarm on the Scanner (0)



Enable Virtual Tether Alarm on the Scanner (1)

Audio Virtual Tether Alarm on Scanner

Parameter # 2246 (SSI # F8h 08h C6h)

This parameter enables the Audio Virtual Tether alarm on the scanner.

Choose the following:

- Enabled - An audio Virtual Tether alarm can be set on the scanner.
- Disabled - An audio Virtual Tether alarm cannot be set on the scanner.



NOTE: When enabled, and the scanner is not in [Night Mode](#), the audio beeper sounds at a high volume..



Disable Audio Virtual Tether Alarm (0)



Enable Audio Virtual Tether Alarm (1)



*Enable Audio Virtual Tether Alarm Except in Night Mode (2)

LED Virtual Tether Alarm on Scanner

Parameter # 2247 (SSI # F8h 08h C7h)

This parameter enables the LED Virtual Tether alarm on the scanner.

Choose the following:

- Enabled - An LED Virtual Tether alarm can be set on the scanner.
- Disabled - An LED Virtual Tether alarm cannot be set on the scanner.



NOTE: When enabled, the scanner LEDs blink green and red..

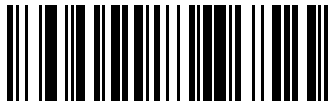

Disable LED Virtual Tether Alarm (0)



*Enable LED Virtual Tether Alarm (1)

Illumination Virtual Tether Alarm on Scanner

Parameter # 2248 (SSI # F8h 08h C8h)

This parameter enables the Illumination Virtual Tether alarm on the scanner.

Choose the following:

- Enabled - An illumination Virtual Tether alarm can be set on the scanner.
- Disabled - An illumination Virtual Tether alarm cannot be set on the scanner.

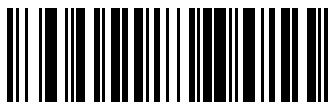

Disable Illumination Virtual Tether Alarm (0)



*Enable Illumination Virtual Tether Alarm (1)

Haptic Virtual Tether Alarm on Scanner

Parameter # 2249 (SSI # F8h 08h C9h)

This parameter enables the Haptic Virtual Tether alarm on the scanner.



NOTE: DPE and XD models only.

Choose the following:

- Enabled - A haptic Virtual Tether alarm can be set on the scanner.
- Disabled - A haptic Virtual Tether alarm cannot be set on the scanner.

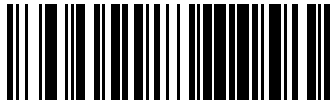

Disable Haptic Virtual Tether Alarm (0)

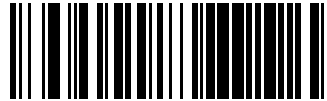

*Enable Haptic Virtual Tether Alarm (1)

Virtual Tether Alarm on the Cradle

Parameter # 2124 (SSI # F8h 4Ch 21h)

This parameter enables the Virtual Tether alarm on the cradle.

Choose the following:

- Enabled - A Virtual Tether alarm can be set on the cradle.
- Disabled - A Virtual Tether alarm cannot be set on the cradle.



NOTE: When enabled, the cradle LEDs blink green and red.



*Disable Virtual Tether Alarm on the Cradle (0)



Enable Virtual Tether Alarm on the Cradle (2)

Delay Before Virtual Alarm Activates

Parameter # 2054 (SSI # F8h 08h 06h)

This parameter enables the device, when out of range, to hold off on sounding the Virtual Tether alarm to provide an opportunity to re-establish a connection.

Ensure that this setting is not too short in order to avoid the following:

- If the cradle resets, it causes the scanner to activate the Virtual Tether alarm.
- Noisy RF environments can lead to frequent, momentary disconnect/reconnect sequences.

To set a delay, choose Delay Before Alarm Activates, and then enter the two numeric barcodes from [Numeric Barcodes](#) that correspond to the desired timeout duration. Enter a leading zero for single digit numbers.

For example, to set a 5 second page timeout, enter 0 barcode and then 5. To correct an error or change the selection, [Cancel](#).

The default value is 30 seconds.

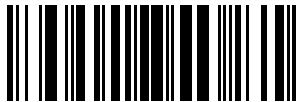

Delay Before Alarm Activates

Virtual Tether Alarm Duration

Parameter # 2055 (SSI # F8h 08h 07h)

This parameter sets the amount of time for the Virtual Tether Alarm to play in minutes (1-99 minutes).

To set a time duration, choose Alarm Duration, and then enter the two numeric barcodes from [Numeric Barcodes](#) that correspond to the desired alarm duration. Enter a leading zero for single digit numbers. The value zero sets the duration to infinite.

The default value is 5 minutes.

For example, to set a 5 second page timeout, enter 0 barcode and then 5. To correct an error or change the selection, [Cancel](#).

The alarm stops once the connection is established, the timeout period expires, or the scanner's battery is drained.



NOTE: Any connection stops the alarm. The scanner does not need to connect to the same cradle.



Alarm Duration

Defeat Virtual Tether Alarm

Parameter # 2119 (SSI # F8h 08h 47h)

This parameter enables the trigger on the scanner or page button on the cradle to defeat or pause the alarm.

Choose the following:

- Do Not Defeat Alarm - The scanner trigger or cradle page button can pause or stop an alarm.
- *Pause Alarm on Trigger Pull/Page Button - The alarm is paused on a trigger pull or page button touch.
- Stop Alarm on Trigger Pull/Page Button - The alarm is stopped on a trigger pull or page button touch.



Do Not Defeat Alarm (0)



*Pause Alarm on Trigger Pull/Page Button (1)

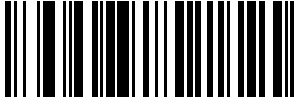

Stop Alarm on Trigger Pull/Page Button (2)

Pause Virtual Tether Alarm Duration

Parameter # 2120 (SSI # F8h 08h 48h)

This parameter pauses the alarm for a number of seconds (1-99 seconds).

To set a time duration, choose Pause Virtual Tether Alarm Duration, and then enter the two numeric barcodes from [Numeric Barcodes](#) that correspond to the desired alarm duration. Enter a leading zero for single digit numbers. The value zero sets the duration to infinite.

For example, to set a 5 second page timeout, enter 0 barcode and then 5. To correct an error or change the selection, [Cancel](#).



Pause Virtual Tether Alarm Duration

Virtual Tether Alarm Considerations

There are many causes for an alarm to activate or not activate. It is also important to know the effects of Battery Preservation mode and Night mode.

Causes for the alarm to activate

- Device going out of range. Depending on configuration, both scanner and cradle can alarm if connection between them is broken due to one of the devices going out of range.
- If cradle is unpowered, the scanner sounds the alarm. Includes USB suspend of the cradle.
- Removing battery from the scanner will cause the cradle to sound the alarm.

Causes for the alarm to not activate

- Scanner and cradle need to have an existing connection before alarm activates. No alarm on power up.
- If the scanner is charging in or paired to another cradle/host by insertion or by scanning the pairing bar code, since it is presumed that in this case the scanner is not lost.
- If another scanner connects to the cradle and causes the original scanner to disconnect.
- If any of the batch modes are enabled or if auto-reconnect is NOT set to reconnect immediately.
- Virtual Tether does not apply to the hosts that do not support auto-reconnect feature such as HID Bluetooth Low Energy (Discoverable) and SPP BT Classic (Discoverable).
- Alarm is not activated if the disconnection occurs due to firmware update or configuration via 123Scan or SMS.
- If scanner is connected to another cradle/host by insertion or by scanning the pairing barcode.

Battery Preservation Mode

If the scanner disconnects from the cradle due to the activation of the Battery Preservation Mode and the Virtual Tether Alarm on the cradle is enabled, only the LEDs on the cradle blink green and red.



NOTE: If Virtual Tether is enabled and a power outage occurs that causes multiple cradles or Bluetooth hosts to lose power, it activates alarms on the scanners paired to them. A trigger pull can be configured to defeat the alarm (see [Defeat Virtual Tether Alarm](#)). The alarms can also be defeated by either disconnecting the battery from the scanner or by pairing the scanner to another cradle or host that has power if one is available.

General Radio Parameters

You can set Batch Mode, Batch Storage, and Beep alert options.

Batch Mode

Parameter # 544 (SSI # F1h 20h)

This parameter enables the scanner to attempt to store barcode data (excluding parameter barcodes) until transmission is initialized or it stores the maximum number of barcodes.

When the scanner saves a barcode successfully, it emits a good decode beep and flashes the green LED. If the scanner is unable to store a new barcode, it emits a low/high/low/high (out of memory) beep. See [Wireless Beeper Definitions](#) for all definitions.

In all modes, calculate the amount of data (number of barcodes) the scanner can store as follows:



NOTE: If you change the batch mode while there is batched data, the new batch mode takes effect only after the scanner sends all previously batched data.

- Normal (default) - Do not batch data. The scanner transmits each barcode when scanned.
- Out-of-Range Batch Mode - The scanner stores barcode data when it loses connection to a remote device (e.g., when the scanner moves out of range). When the scanner re-establishes connection with the device (e.g., it moves back into range), it transmits the data.
- Standard Batch Mode - The scanner stores barcode data when you scan Enter Batch Mode. Scan Send Batch Data to transmit the data.



NOTE: Transmission stops if the scanner loses connection to the remote device.

- Cradle Contact Batch Mode - The scanner stores barcode data when you scan Enter Batch Mode. Insert the scanner into the cradle to transmit the data.



NOTE: If you remove the scanner from the cradle during batch data transfer, transmission stops until you re-insert the scanner in the cradle.

- Batch Only Mode - The scanner radio is off, and the scanner stores all barcode data. Insert the scanner into the cradle to transmit the data.



NOTE: Removing the scanner from the cradle during batch data transfer stops transmission until you re-insert it in the cradle.



NOTE: The radio may be turned off during batch data transmission.



NOTE: To exit this mode, scan the **Normal (Do Not Batch Data)** barcode.

- Parameter Batch Mode - Use this mode if the cradle and/or scanner is configured with the radio turned off or connected to a non-cradle device. Scan **Enter Parameter Batch Mode** to enter this mode. The scanner stores parameter barcode data intended for the cradle. Insert the scanner into the cradle to transmit the batched parameter data. When data transmission is complete, the scanner exits this mode. Alternatively, scan **Exit Parameter Batch Mode** to cancel batching before inserting the scanner in the cradle.

In all modes, transmission stops if the scanner moves out of range and resumes when the scanner moves back in range. If you scan a barcode during batch data transmission, it is appended to the end of the batched data. Parameter barcodes are not stored.

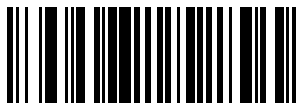

*Normal (Do Not Batch Data) (0)



Out of Range Batch Mode (1)

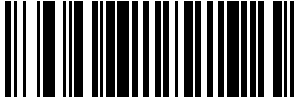

Standard Batch Mode (2)

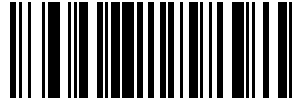

Cradle Contact Batch Mode (3)

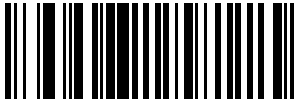

Batch Only Mode (4)

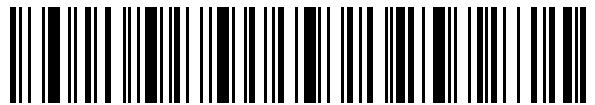

Enter Batch Mode

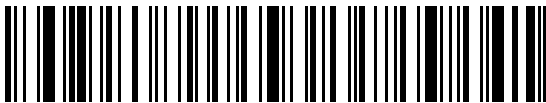

Send Batch Data

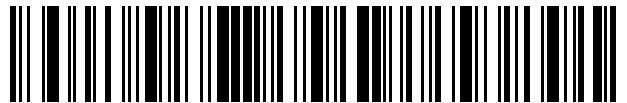

Enter Parameter Batch Mode



Exit Parameter Batch Mode

Beep on Insertion

Parameter # 288 (SSI # F0h 20h)

The parameter enables the scanner to emit a short low beep when it is inserted into a cradle and detects power.

Choose the following:

- Enabled - Scanner beeps when inserted in cradle.
- Disabled - Scanner does not beep when inserted in cradle.



*Enable Beep on Insertion (1)

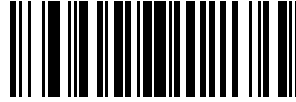

Disable Beep on Insertion (0)

Bluetooth SPP Beep on <BEL>

Parameter # 150 (SSI # 96h)

This parameter enables the scanner to beep when it detects a <BEL> character on the serial line. <BEL> is issued to alert the user of an illegal entry or other important event.

Choose the following:

- Enabled - Scanner beeps when it detects a <BEL>.
- Disabled - Scanner does not beep when it detects a <BEL>.



NOTE: This parameter only applies to SPP (Serial Port Profile), for example, the serial interface on the cradle. In Multipoint-to-Point mode only, the scanner that beeped last sounds Beep on <Bel>.



*Enable Beep on <BEL> (1)



Disable Beep on <BEL> (0)

Bluetooth Radio, Linking, and Batch Operation

The scanner has a Bluetooth Class 1 radio which achieves a range of at least 100 m / 300 ft (open air, line of sight). The actual range achieved is influenced by the presence of other radios, shelving, and wall materials and which cradle is tested. The environments vary widely and often influence radio ranges.

When the scanner moves out of communications range to the base, you can configure it for [Batch Mode](#). The scanner has sufficient on-board memory to store more than 500 barcodes of typical size (UPC/EAN). See [Batch Mode](#) to calculate the amount of data (number of barcodes) the scanner can store.

Linking the Scanner to an iOS or Android Device

To establish a link between the scanner and the device, scan [HID Keyboard Emulation](#). Then perform one of the following:

- iOS/iPad/iPhone - Select **Settings > General > Bluetooth** and turn Bluetooth **On**. Choose the scanner from the list of discovered devices to establish a link allowing scanning into any application with keyboard entry.
- Android - If Bluetooth is off, select **Settings > Wireless & networks > Bluetooth** to turn it on. Select **Bluetooth Settings** and choose the scanner from the list of discovered devices. The scanner usually displays as DSYYYY - xxxxxx, where xxxxxx is the serial number.



IMPORTANT: Android devices that require scanning a PIN for connection display a PIN. To enter the PIN, scan [Variable Pin Code](#), and then attempt connection. When the scanner beeps to indicate it is waiting for PIN entry, scan the PIN using [Numeric Barcodes](#). To delete incorrect scanned entries, scan [Cancel](#). For more information, see [Variable Pin Code](#).

User Preferences and Miscellaneous Options

You can program the scanner to perform various functions or activate different features. This section describes user preference features and provides programming barcodes for selecting these features.

The scanner ships with the settings shown in . If the default values suit requirements, programming is not necessary.

Setting User Preference Parameters

To set feature values, scan a single barcode or a short barcode sequence. The settings are stored in non-volatile memory and are preserved even when the scanner powers down.



NOTE: Most computer monitors allow scanning barcodes directly on the screen. When scanning from the screen, be sure to set the document magnification to a level where you can see the barcode clearly, and bars and/or spaces do not merge.

If not using the default host, select the host type (see each host section for specific host information) after the power-up beeps sound. This is only necessary upon the first power-up when connected to a new host.

To return all features to default values, see [Default Parameters](#). Throughout the programming barcode menus, asterisks indicate (*) default values.

User Preference Scanning Sequence Examples

In most cases, scanning one barcode sets the parameter value.

Other parameters require scanning several barcodes. Relevant parameters contain descriptions for this procedure.

User Preference Errors While Scanning

Unless otherwise specified, to correct an error during a scanning sequence, re-scan the correct parameter.

User Preferences/Miscellaneous Options Parameter Defaults

The table below lists defaults for user preference and miscellaneous option parameters. Change these values in one of two ways:

- Scan the appropriate barcodes in this section. The new value replaces the standard default value in memory. To recall default parameter values, see [User Preferences Parameter Defaults](#).

- Configure the scanner using the 123Scan configuration program. See [123Scan and Software Tools](#).



NOTE: Standard parameter defaults are available in each section of this guide.

Table 14 User Preferences Parameter Defaults

Parameter	Parameter Number ^a	SSI Number ^b	Default
User Preferences			
Set Default Parameter	N/A	N/A	N/A
Parameter Barcode Scanning	236	ECh	Enable
Beep After Good Decode	56	38h	Enable
Beeper Volume	140	8Ch	High
Beeper Tone	145	91h	Medium
Beeper Duration	628	F1h 74h	Medium
Suppress Power-Up Beeps	721	F1h D1h	Enable
LED on Good Decode	744	F1h E8h	Enable
Direct Decode Indicator	859	F2h 5Bh	Disable
Decode Pager Motor ^c	613	F1h 65h	Enable
Decode Pager Motor Duration ^c	626	F1h 72h	150 msec
Night Mode Trigger ^c	1215	F8h 04h	Disable
Night Mode Toggle ^c	N/A	N/A	N/A
Night Mode Silence Beeper Radio Indications ^c	2262	F8h 08h D6	Enable Always
Night Mode Silence Beeper Low Battery Indication ^c	2263	F8h 08h D7	Enable Always
Night Mode Silence Beeper Parameter Programming Indications ^c	2264	F8h 08h D8	Enable Always
Battery Preservation Mode	1765	F8h 06h E5h	Enable
Low Battery Threshold	1369	N/A	10%
Time Delay to Low Power Mode	146	92h	5 sec
Timeout to Low Power Mode from Auto Aim	729	F1h D9h	15 sec
Hand-held Trigger Mode	138	8Ah	Level
Hand-held Decode Aiming Pattern	306	F0h 32h	Enable
Hands-free (Presentation) Decode Aiming Pattern	590	F1h 4Eh	Disable
Hands-free Mode	630	F1h 76h	Enable
Picklist Mode	402	F0h 92h	Disable Picklist Mode Always

Table 14 User Preferences Parameter Defaults (Continued)

Parameter	Parameter Number ^a	SSI Number ^b	Default
Continuous Barcode Read	649	F1h 89h	Disable
Unique Barcode Reporting	723	F1h D3h	Enable
Decode Session Timeout	136	88h	9.9 Seconds
Hands-Free Decode Session Timeout	400	F0 90	15
Timeout Between Decodes, Same Symbol	137	89h	0.5 Seconds
Timeout Between Decodes, Different Symbols	144	90h	0.1 Seconds
Triggered Timeout, Same Symbol	724	F1h D4h	Disable Triggered Timeout, Same Symbol
Mobile Phone/Display Mode	716	F1h CCh	Normal Mobile Phone/Display Mode
PDF Prioritization	719	F4h F1h CFh	Disable
PDF Prioritization Timeout	720	F1h D0h	200 ms
Presentation Mode Field of View	609	F1h 61h	Full Field of View
Decoding Illumination	298	F0h 2Ah	Enable
Illumination Brightness Hand-held	669	F1h 9Dh	High
Motion Tolerance (Hand-held Trigger Mode Only)	858	F2h 5Ah	Less
Product ID (PID) Type	1281	F8h 05h 01h	Host Type Unique
Product ID (PID) Value	1725	F8h 06h BDh	0
ECLevel	1710	F8h 06h AEh	0
DPM Parameters			
DPM Illumination Control	429	F0h ADh	Cycle
DPM Mode	1438	F8h 05h 9Eh	Enable
Miscellaneous Options			
Enter Key	N/A	N/A	N/A
Tab Key	N/A	N/A	N/A
Transmit Code ID Character	45	2Dh	None
Prefix Value	99, 105	63h, 69h	7013 <CR><LF>
Suffix 1 Value	98, 104	62h, 68h	7013 <CR><LF>
Suffix 2 Value	100, 106	64h, 6Ah	7013 <CR><LF>
Scan Data Transmission Format	235	EBh	Data As Is
FN1 Substitution Values	103, 109	67h, 6Dh	7013 <CR><LF>
Transmit "No Read" Message	94	5E	Disable

Table 14 User Preferences Parameter Defaults (Continued)

Parameter	Parameter Number ^a	SSI Number ^b	Default
Unsolicited Heartbeat Interval	1118	F8h 04h 5Eh	Disable
securPharm Decoding	1752	F8 06h D8h	Disable
securPharm Output Formatting	1753	F8h 06h D9h	No Formatting
Battery Charging User Indication Enhancement	2255	F8h 08h CFh	Blink Amber

^a Parameter number decimal values are used for programming via RSM commands.

^b SSI number hex values are used for programming via SSI commands.

^c DS4678 and DS4678-XD only

User Preferences

Set feature values by scanning the desired parameter values.

Default Parameters

Scan one of the following barcodes to reset the scanner to its default settings.

- Restore Defaults resets all default parameters as follows:
 - If you configured custom default parameter values via the Write to Custom Defaults barcode, scanning the Restore Defaults barcode restores these custom values.
 - If you did not configure custom default parameter values, scanning the Restore Defaults barcode restores the factory default values. Default values are available at the beginning of each section.
- Set Factory Defaults clears all custom default values and sets the factory default values. Default values are available at the beginning of each section.
- Write to Custom Defaults configures default parameters to set unique default values for all parameters. After changing all parameters to the desired default values, scan the **Write to Custom Defaults** barcode below to configure custom defaults.

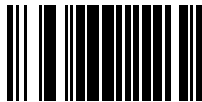

Restore Defaults

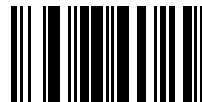

Set Factory Defaults

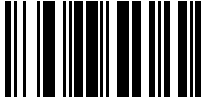

Write to Custom Defaults

Parameter Barcode Scanning

Parameter # 236 (SSI # ECh)

This parameter selects whether to enable or disable the decoding of parameter barcodes, including the Set Defaults barcodes.

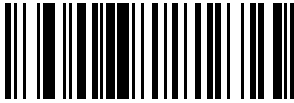

*Enable Parameter Barcode Scanning (1)

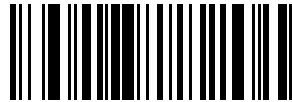

Disable Parameter Barcode Scanning (0)

Beep After Good Decode

Parameter # 56 (SSI # 38h)

This parameter selects whether or not the scanner beeps after a good decode. If you select Disable Beep After Good Decode, the beeper still operates during parameter menu scanning and to indicate error conditions.

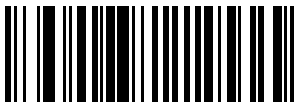

*Enable Beep After Good Decode (1)

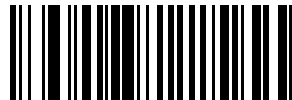

Disable Beep After Good Decode (0)

Beeper Volume

Parameter # 140 (SSI # 8Ch)

This parameter selects a beeper volume.

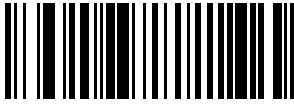

Low Volume (2)

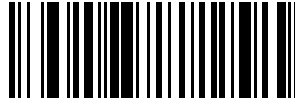

Medium Volume (1)

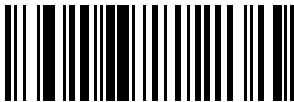

*High Volume (0)

Beeper Tone

Parameter # 145 (SSI # 91h)

This parameter selects a beeper tone for a good decode beep.



Disable Tone (3)



Low Tone (2)



*Medium Tone (1)



High Tone (0)



Medium to High Tone (2-tone) (4)

Beeper Duration

Parameter # 628 (SSI # F1h 74h)

This parameter selects the duration for the good decode beep.



Short Duration (0)



*Medium Duration (1)



Long Duration (2)

Suppress Power Up Beeps

Parameter # 721 (SSI # F1h D1h)

This parameter selects whether or not to suppress the scanner's power-up beeps.

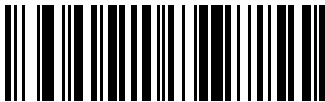

*Do Not Suppress Power Up Beeps (0)

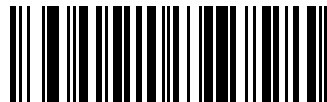

Suppress Power Up Beeps (1)

LED on Good Decode

Parameter # 744 (SSI # F1h E8h)

This parameter selects whether or not the LED blinks on a good decode.



*Enable LED on Good Decode (2)



Disable LED on Good Decode (0)

Direct Decode Indicator

Parameter # 859 (SSI # F2h 5Bh)

This parameter selects an optional blinking indicator on successful decode if you continue to hold the trigger.

This allows you to choose additional feedback for a successful decode by holding the trigger or continuing to scan as normal.

- ***Disable Direct Decode Indicator** - does not blink on a successful decode.
- **1 Blink** - blinks once upon a successful decode.
- **2 Blinks** - blinks twice upon a successful decode.



*Disable Direct Decode Indicator (0)

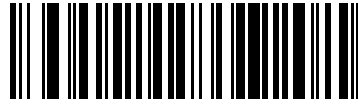

1 Blink (1)



2 Blinks (2)

Decode Pager Motor

Parameter # 613 (SSI # F1h 65h)

The scanner includes a pager motor which, when enabled, vibrates the scanner for a period of time when a successful decode occurs. This parameter enables or disables the pager motor.



NOTE: For DPE/XD models only. While the scanner is docked, the pager motor is disabled.

If enabled, select a [Decode Pager Motor Duration](#) option to set the duration of the pager motor vibration.



*Enable Pager Motor (1)

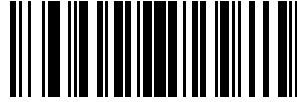

Disable Pager Motor (0)

Decode Pager Motor Duration

Parameter # 626 (SSI # F1h 72h)

If Decode Pager Motor is enabled, scan one of the following barcodes to set the duration of the pager motor vibration.

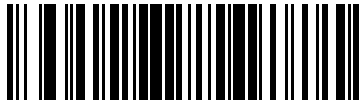

*150 msec (15)

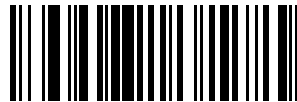

200 msec (20)



250 msec (25)

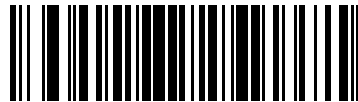

300 msec (30)



400 msec (40)



500 msec (50)

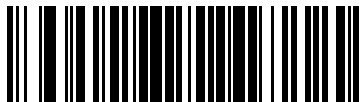

600 msec (60)

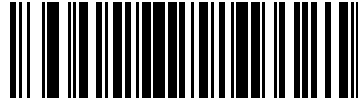

750 msec (75)

Night Mode

This parameter allows you to easily switch to a quiet mode in order to use the pager motor with the beeper off.



NOTE: For DPE and XD only.

Entering Night Mode enables [Decode Pager Motor](#), and disables [Beep After Good Decode](#).

Enter and exit Night Mode in one of two ways:

- If [Night Mode Trigger](#) is enabled, you can use the trigger to toggle between entering and exiting Night Mode. To do this, point the scanner away from a barcode and press the trigger until the beam goes off. Hold the trigger for an additional 5 seconds. Note that after decoding a barcode, holding the trigger for an additional 5 seconds has no effect.
- Use [Night Mode Toggle](#) to enter or exit Night Mode, regardless of the state of the [Night Mode Trigger](#) parameter.

Also, note the following scanner behavior regarding Night Mode:

- Exiting Night Mode returns the scanner to the previously programmed states for the three parameters changed. For example, if [Beep After Good Decode](#) was enabled before entering Night Mode, it returns to enabled upon exiting Night Mode.
- When entering Night Mode, the pager motor vibrates. When exiting Night Mode, the scanner emits two short beeps.
- Scanning a [Default Parameters](#) barcode causes the scanner to exit Night Mode.
- For scanners that do not use a pager motor, scanning any of the Night Mode parameters or the pager motor parameters results in an error beep.
- If the scanner loses power while in Night Mode because a cable is disconnected, on the next power up the scanner exits Night Mode and resumes normal operation.

Night Mode Trigger

Parameter # 1215 (SSI # F8h 04h BFh)

Enable Night Mode Trigger to use the trigger to toggle between entering and exiting Night Mode. To toggle, point the scanner away from a barcode, press the trigger until the beam goes off, and then hold the trigger for an additional 5 seconds. Note that pressing the trigger an additional 5 seconds after decoding a barcode has no effect.



NOTE: For DPE and XD only.

When entering Night Mode, the pager motor vibrates. When exiting Night Mode, the scanner emits two short beeps.

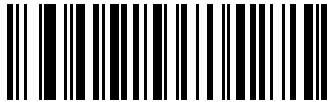

Enable Night Mode Trigger (1)

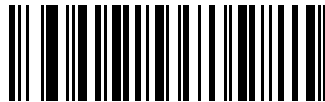

*Disable Night Mode Trigger (0)

Night Mode Toggle



NOTE: For DPE and XD only.

Scan this barcode to toggle between entering and exiting Night Mode without using the trigger. This functions regardless of the state of the Night Mode Trigger parameter.

When entering Night Mode, the pager motor vibrates. When exiting Night Mode, the scanner emits two short beeps.



Toggle Night Mode

Night Mode Silence Beeper Radio Indications

Parameter # 2262 (SSI # F8h 08h D6)

This parameter selects whether to enable or disable this feature.



Disable Always (0)

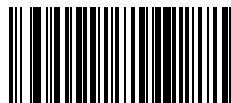

*Enable Always (1)



Disable in Night Mode (2)

When **Disable in Night Mode** or **Disable Always** is active, the following radio beeper indications are silenced:

Radio Indication Name	Beeper Sequence	Radio Indication
Bluetooth page timeout	Long low/long high	Remote device is out of range/ not powered.
Bluetooth connection attempt	Long low/long high/long low/ long high	Bluetooth connection attempt is rejected by remote device.

Night Mode Silence Beeper Low Battery Indication

Parameter # 2263 (SSI # F8h 08h D7)

This parameter enables or disables the Night Mode Silence Beeper Low Battery Indication feature.

When Disable in Night Mode or Disable Always is active, the low battery (on the trigger release) beeper indication of four short high beeps is silenced.

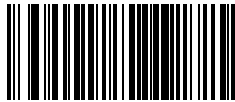

Disable Always (0)

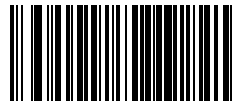

*Enable Always (1)

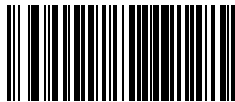

Disable in Night Mode (2)

Night Mode Silence Beeper Parameter Programming Indications

Parameter # 2264 (SSI # F8h 08h D8)

This parameter selects whether to enable or disable this feature.

This parameter enables silencing the beep that occurs when the scanner is being programmed if the parameter is set to Disable in Night Mode or Disable Always.



Disable Always (0)



*Enable Always (1)

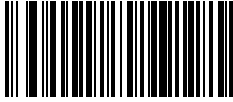

Disable in Night Mode (2)

When **Disable in Night Mode** or **Disable Always** is active, the following parameter barcode programming beeper indications are silenced:

Parameter Programming Indication Name	Beeper Sequence	Parameter Programming Indication
Input Error	Long low/long high	Incorrect barcode or Cancel scanned, wrong entry, incorrect barcode programming sequence; remain in program mode.
Keyboard parameter selected	High/low	Enter value using barcode keypad.
Successful programming	High/low/high/low	Successful program exited with change in the parameter setting.
ADF Programming		
Number expected	High/low	Enter another digit. Adding leading zeros to find the front, if necessary.
Alpha expected	Low/low	Enter another alphabetic character or scan the End of Message barcode.
ADF criteria/action expected	High/high	Enter another criteria or action or scan the Save Rule barcode.
ADF criteria/action cleared	High/low/low	All criteria or actions cleared for current rule, continuing entering rule.
Rule saved	High/low/high/low	Rule successfully saved, and rule entry mode exited.
Rule error	Long low/long high	Entry error, wrong barcode scanned, or criteria/action list is too long for a rule. Re-enter criteria or action.
Deleted last saved rule	Low	Deletes the last saved rule but the current rule is left intact.
All rules deleted	Long high/high	All rules entered are deleted.
Out of memory	Long low/long high/long low/long high	Out of ADF memory. Erase some existing rules, then try to erase the rule again.
Cancel rule entry	Long low/long high/long low	Rule entry mode exited because of an error, or the user asked to exit rule entry.

Battery Preservation Mode

Parameter # 1765 (SSI # F8h 06h E5h)

Battery Preservation Mode preserves the battery charge when the scanner is not being used for an extended period of time.

Notes

When asleep in Battery Preservation Mode, you cannot access the scanner for remote management.

Set the Battery Preservation Timeout Value to change the amount of time before the battery disconnects from the scanner.

- Use Enable Battery Preservation Mode to internally disconnect the battery from the scanner when the scanner is unused and not being charged for nine hours (default). In this mode the scanner completely turns off. This preserves the battery charge and significantly extends battery shelf life. To exit Battery Preservation Mode and return to normal operation, press the scanner trigger or return to charging. The scanner cannot scan until the wake-up process completes. This takes a few seconds.
- Use Disable Battery Preservation Mode to keep the battery connected to the scanner at all times. This prevents the battery from disconnecting from the scanner after nine hours of sitting idle (no scanning) and not charging. Substantial battery shelf life improvements are not gained as when Battery Preservation Mode is enabled.
- Use Battery Preservation Timeout followed by 3 digits in [Numeric Barcodes](#) to select a different battery preservation timeout value (the default is nine hours). For example, to set the preservation timeout value to 12 hours, scan Battery Preservation Timeout, and then scan 0, 1, and 2 in [Numeric Barcodes](#). To correct an error or change the selection, scan [Cancel](#).



*Enable Battery Preservation Mode (9)

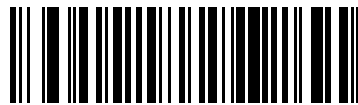

Disable Battery Preservation Mode (0)

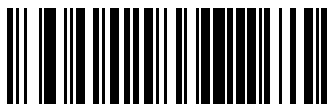

Battery Preservation Timeout Value

Battery Threshold

Scan the barcode below to select the desired battery status threshold.

Battery Status Low Threshold - Parameter # 1369

This parameter sets the threshold used to show the battery status is low. When the charge status is below the low warning threshold on every trigger release, the scanner issues four short beeps.

Scan this barcode followed by two digits from [Numeric Barcodes](#) that correspond to the desired percentage from 00 to 99. The default is 10%.

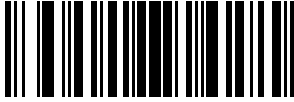

Time Delay to Low Power Mode

Parameter # 146 (SSI # 92h)

This parameter sets the time the scanner remains active before entering low power mode. The scanner wakes upon trigger press or when the host attempts to communicate with the scanner.

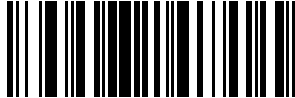

100 msec (65)

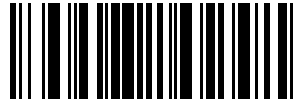

500 msec (69)

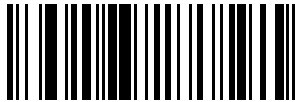

1 sec (17)

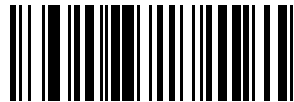

2 sec (18)



3 sec (19)

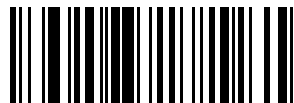

4 sec (20)



*5 sec (21)



10 sec (26)



15 sec (27)

Timeout to Low Power Mode from Auto Aim

Parameter # 729 (SSI # F1h D9h)

This parameter sets the time the scanner remains in auto aim before entering low power mode.

See [Trigger Mode](#) for an explanation of auto aim mode.



Disable Timeout to Low Power Mode from Auto Aim (0)

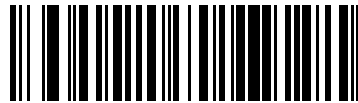

5 Seconds (85)



*15 Seconds (11)

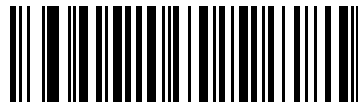

30 Seconds (13)



1 Minute (17)

Hand-Held Trigger Mode

Parameter # 138 (SSI # 8Ah)

This parameter allows you to change your scanner's behavior to initiate a decode.

Choose one of the following to select a trigger mode for the scanner:

- Standard (Level) - A trigger press activates decode processing. Decode processing continues until the barcode decodes, you release the trigger or the [Decode Session Timeout](#) occurs. If the trigger is released before the timeout expires, the decode session terminates and no decode occurs.
- Presentation (Blink) - The scanner activates decode processing when it detects a barcode in its field of view. After a period of non-use, the LEDs turn off until the scanner senses motion.

- Auto Aim - The scanner projects the aiming pattern when lifted. A trigger press activates decode processing. After five seconds of inactivity the aiming pattern shuts off.



*Standard (Level) (0)

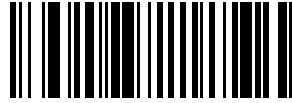

Presentation (Blink) (7)

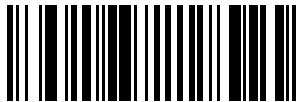

Auto Aim (9)

Hand-held Decode Aiming Pattern

Parameter # 306 (SSI # F0h 32h)

This parameter selects when to project the aiming pattern in hand-held mode:

- Enable Hand-held Decode Aiming Pattern - This projects the aiming pattern during barcode capture.
- Disable Hand-held Decode Aiming Pattern - This turns the aiming pattern off.
- Enable Hand-held Decode Aiming Pattern on PDF - This projects the aiming pattern when the scanner detects a PDF barcode.



NOTE: With [Picklist Mode](#) enabled, the decode aiming pattern flashes even if you disable the Hand-held Decode Aiming Pattern.

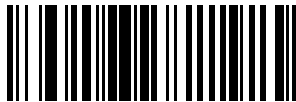

*Enable Hand-held Decode Aiming Pattern (2)

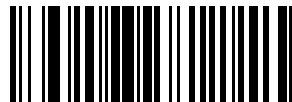

Disable Hand-held Decode Aiming Pattern (0)

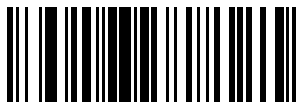

Enable Hand-held Decode Aiming Pattern on PDF (3)

Hands-free (Presentation) Decode Aiming Pattern

Parameter # 590 (SSI # F1h 4Eh)

This parameter selects when to project the aiming pattern in hands-free mode.

- Enable Hands-free (Presentation) Decode Aiming Pattern - This projects the aiming pattern during barcode capture.
- Disable Hands-free (Presentation) Decode Aiming Pattern - This turns the aiming pattern off.
- Enable Hands-free (Presentation) Decode Aiming Pattern on PDF - This projects the aiming pattern when the scanner detects a PDF barcode.



NOTE: With [Picklist Mode](#) enabled, the decode aiming pattern flashes even when you disable the Hands-free Decode Aiming Pattern.



Enable Hands-free (Presentation) Decode Aiming Pattern (1)

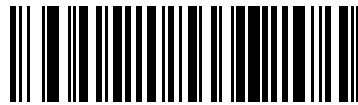

*Disable Hands-free (Presentation) Decode Aiming Pattern (0)



Enable Hands-free (Presentation) Decode Aiming Pattern on PDF (2)

Hands-free Mode

Parameter # 630 (SSI # F1h 76h)

This parameter enables or disables hands-free mode:

- Enable Hands-free Mode - When you place the scanner, it automatically triggers when presented with a barcode. causes it to behave according to the setting of the [Trigger Mode](#).
- Disable Hands-free Mode - The scanner behaves according to the setting of the [Trigger Mode](#) regardless of whether it is hand-held or .



*Enable Hands-free Mode (1)

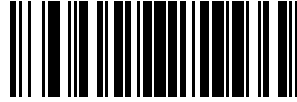

Disable Hands-free Mode (0)

Picklist Mode

Parameter # 402 (SSI # F0h 92h)

This parameter selects a Picklist Mode. In this mode, you can pick out and decode a barcode from a group of barcodes that are printed close together by placing the aiming pattern on the barcode you want to decode.



NOTE: Enabling Picklist Mode overrides the Disable Decode Aiming Pattern options. You can not disable the decode aiming pattern when Picklist Mode is enabled. Enabling Picklist Mode can slow decode speed and hinder the ability to decode longer barcodes.

- Enable Picklist Mode Always - Picklist Mode is always enabled.
- Enable Picklist Mode in Hand-held Mode - Picklist Mode is enabled when the scanner is out of hands-free mode and disabled when the scanner is in presentation mode.
- Enable Picklist Mode in Hands-free Mode - Picklist Mode is enabled when the scanner is in hands-free mode only.
- Disable Picklist Mode Always - Picklist Mode is always disabled.

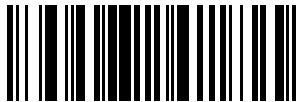

Enable Picklist Mode Always (2)



Enable Picklist Mode in Hand-held Mode (1)

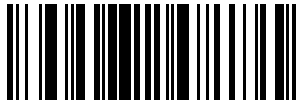

Enable Picklist Mode in Hands-free Mode (3)

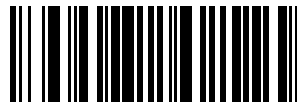

*Disable Picklist Mode Always (0)

Continuous Barcode Read

Parameter # 649 (SSI # F1h 89h)

Enable this parameter to report every barcode while the trigger is pressed.

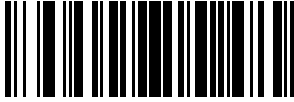

Enable Continuous Barcode Read (1)

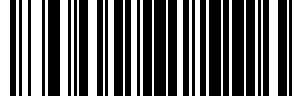

*Disable Continuous Barcode Read (0)

Unique Barcode Reporting

Parameter # 723 (SSI # F1h D3h)

Enable this parameter to report only unique barcodes while the trigger is pressed. This option only applies when Continuous Barcode Read is enabled.

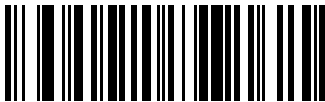

*Enable Unique Barcode Reporting (1)

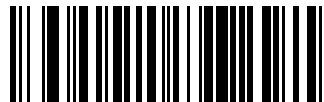

Disable Unique Barcode Reporting (0)

Decode Session Timeout

Parameter # 136 (SSI # 88h)

This parameter sets the maximum time decode processing continues during a scan attempt. It is programmable in 0.1 second increments from 0.5 to 9.9 seconds. The default timeout is 9.9 seconds.

To set a Decode Session Timeout, scan the following barcode, and then scan two barcodes from [Numeric Barcodes](#) that correspond to the desired on time. Enter a leading zero for single digit numbers. For example, to set a Decode Session Timeout of 0.5 seconds, scan this barcode, and then scan the 0 and 5 barcodes. To correct an error or change the selection, scan [Cancel](#).



Decode Session Timeout

Hands-Free Decode Session Timeout

Parameter # 400 (SSI # F0 90)

This parameter is the hands-free compliment to the Decode Session Timeout. It configures the minimum and maximum decode processing time during a hands-free scan attempt. It only applies to the hands-free trigger mode or when a scanner is placed in the gooseneck stand.

The range for this parameter is 2-255 with a default value of 15.

The minimum decode processing time is defined as the time in which the scanner stops decoding when an object is removed or left stationary in the imaging field of view.

The maximum decode processing time is defined as the time in which the scanner stops decoding when an object is left in or is moving in the field of view.

Both the maximum and minimum times are configured using a single setting. The relationship of this setting is as follows:

Setting Value ^a	Minimum Time	Maximum Time
X < 25	250 ms	2.5 seconds
X >= 25	X * 10 ms	X * 100 ms

^a value must be three digits.

For example, a setting value of 100 results in the scanner turning off approximately 1 second after an object is removed from the field of view or 10 seconds while an object is in the field of view moving.

The default value of the setting is 15, which results in a minimum time of 250 ms and a maximum time of 2.5 sec.

Adjust this setting based on your requirements. For example, when doing PDF prioritization, this parameter should be set to a value where the maximum time is above the PDF prioritization timeout.

To set a three-digit value, scan the following barcode and then scan three barcodes from [Numeric Barcodes](#). Enter a leading zero for single-digit numbers. To correct an error or change a selection, scan Cancel.



Hands-Free Decode Session Timeout

Timeout Between Decodes, Same Symbol

Parameter # 137 (SSI # 89h)

Use this option in presentation mode or Continuous Barcode Read mode to prevent the scanner from continuously decoding the same barcode when it is left in the scanner's field of view. The barcode must be out of the field of view for the timeout period before the scanner reads the same consecutive symbol.

Timeout Between Decodes, Same Symbol is programmable in 0.1 second increments from 0.0 to 9.9 seconds. The default interval is .

To select the timeout between decodes for the same symbol, scan the following barcode, and then scan two barcodes from [Numeric Barcodes](#) that correspond to the desired interval, in 0.1 second increments.

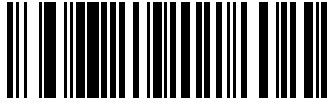

Timeout Between Decodes, Same Symbol

Timeout Between Decodes, Different Symbols

Parameter # 144 (SSI # 90h)

Use this option in presentation mode or Continuous Barcode Read to control the time the scanner waits before decoding a different symbol.

Timeout Between Decodes, Different Symbols is programmable in 0.1 second increments from 0.1 to 9.9 seconds. The default is 0.1 seconds.

To select the timeout between decodes for different symbols, scan the following barcode, and then scan two barcodes from [Numeric Barcodes](#) that correspond to the desired interval, in 0.1 second increments.

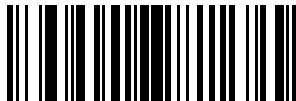

Timeout Between Decodes, Different Symbols

Triggered Timeout, Same Symbol

Parameter # 724 (SSI # F1h D4h)

Enable Triggered Timeout, Same Symbol to apply Timeout Between Decodes, Same Symbol in hand-held trigger mode.



NOTE: This feature does not apply to Timeout Between Decodes, Different Symbols.

Timeout Between Decodes, Same Symbol cannot be greater than or equal to [Time Delay to Low Power Mode](#).

Subsequent scans of Enable Triggered Timeout, Same Symbol are ignored until Timeout Between Decodes, Same Symbol expires.



Enable Triggered Timeout, Same Symbol (1)

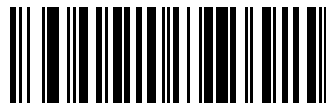

* Disable Triggered Timeout, Same Symbol (0)

Mobile Phone/Display Mode

Parameter # 716 (SSI # F1h CCh)

This mode improves barcode reading performance off mobile phones and electronic displays. Scan one of the following barcodes to select the desired mode.



*Normal Mobile Phone/Display Mode (0)



Enhanced in Hand-held Mode (1)



Enhanced in Hands-free Mode (2)

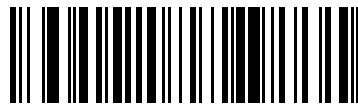

Enhanced in Both Modes (3)

PDF Prioritization

Parameter # 719 (SSI # F4h F1h CFh)

Enable this parameter to delay decoding certain 1D barcodes by the value specified in PDF Prioritization Timeout.

During the [PDF Prioritization Timeout](#) time, the scanner attempts to decode a PDF417 symbol (for example, on a US driver's license), and if successful, reports this only. If it does not decode (cannot find) a PDF417 symbol, it reports the 1D symbol after the timeout. The 1D symbol must be in the device's field of view for the scanner to report it. This parameter does not affect decoding other symbologies.

The 1D Code 128 barcode lengths include the following:

- 7 to 10 characters
- 14 to 22 characters
- 27 to 28 characters

In addition, a Code 39 barcode with the following lengths are considered to potentially be part of a US driver's license:

- 8 characters
- 12 characters



Enable PDF Prioritization (1)



*Disable PDF Prioritization (0)

PDF Prioritization Timeout

Parameter # 720 (SSI # F1h D0h)

If you enabled PDF Prioritization, set this timeout to indicate how long the scanner attempts to decode a PDF417 symbol before reporting the 1D barcode in the field of view.

The PDF Prioritization Timeout range is 0 to 5000 ms, and the default is 200 ms.

Scan the following barcode, and then scan four barcodes from [Numeric Barcodes](#) that specify the timeout in milliseconds. For example, to enter 400 ms, scan the following barcode, and then scan 0400.



PDF Prioritization Timeout

Presentation Mode Field of View

Parameter # 609 (SSI # F1h 61h)

This parameter sets the size of the search area.

In presentation mode, the default setting of Full Field of View allows the scanner to search the entire area of the imaging field of view.

Select Small Field of View or Medium Field of View to search for a barcode in a smaller centered region of the imaging field of view to speed search time.

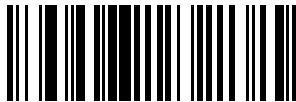

Small Field of View (0)



Medium Field of View (1)



*Full Field of View (2)

Decoding Illumination

Parameter # 298 (SSI # F0h 2Ah)

This parameter determines whether the scanner turns on illumination to aid decoding. Enabling illumination usually results in superior images and better decode performance. The effectiveness of the illumination decreases as the distance to the target increases.

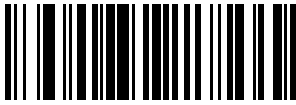

*Enable Decoding Illumination (1)

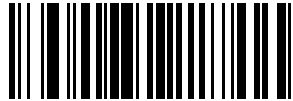

Disable Decoding Illumination (0)

Illumination Brightness Hand-Held

Parameter # 669 (SSI # F1h 9Dh)

This parameter sets the illumination brightness used during an active decode session. This only applies in hand-held mode (not in presentation mode).



NOTE: Selecting a lower brightness level can affect decode performance.



Low Illumination Brightness (0)



Medium Illumination Brightness (3)



*High Illumination Brightness (9)

Motion Tolerance

Parameter # 858 (SSI # F2h 5Ah)

This parameter selects a motion tolerance option.



NOTE: Hand-held Trigger modes only.

- *Less Motion Tolerance - This provides optimal decoding performance on 1D barcodes.
- More Motion Tolerance - This increases motion tolerance and speeds decoding when scanning a series of 1D barcodes in rapid progression.



*Less Motion Tolerance (0)



More Motion Tolerance (1)

Product ID (PID) Type

Parameter # 1281 (SSI # F8h 05h 01h)

This parameter defines the PID value reported in USB enumeration.

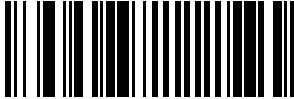

*Host Type Unique (0)

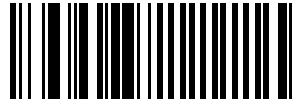

Product Unique (1)

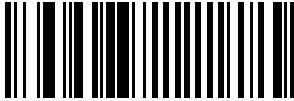

IBM Unique (2)

Product ID (PID) Value

Parameter # 1725 (SSI # F8h 06h BDh)

This parameter sets a Product ID (PID) value.



NOTE: This parameter applies to customers using a Firmware Flash Update per the Toshiba Global Commerce Solutions (TGCS) Universal Serial Bus OEM Point-of-Sale Device Interface.

To set a Product ID value, scan Set PID Value, and then scan four numeric barcodes in [Numeric Barcodes](#) that correspond to the value. Enter a leading zero for single-digit numbers. To correct an error, or change a selection, scan [Cancel](#). The range is (0, 1600 - 1649).



Set PID Value

ECLevel

Parameter # 1710 (SSI # F8h 06h AEh)

This parameter sets an ECLevel.



NOTE: This parameter applies to customers using a Firmware Flash Update per the Toshiba Global Commerce Solutions (TGCS) Universal Serial Bus OEM Point-of-Sale Device Interface. It allows defining an ECLevel value to manage and control Flash Update operations on the 4690 operating system.

Contact Zebra Support at zebra.com/support for more information.

To set an ECLevel value, scan Set ECLevel, and then scan five numeric barcodes in [Numeric Barcodes](#) that correspond to the desired level. Enter a leading zero for single digit numbers. To correct an error, or change a selection, scan [Cancel](#).



Set ECLevel

DPM Parameters

Unlike barcodes that are typically printed on labels, a direct part mark (DPM) is a symbol that is marked directly on an item's surface for permanent identification using methods such as laser etching and dot peening. The DS4678-DP (DPM) reader scans these symbols.

DPM Illumination Control

Parameter # 429 (SSI #F0h ADh)

This parameter controls the Illumination for DPM barcode reading.

- Direct Illumination - scanner uses only the direct illumination.
- Indirect Illumination - scanner uses only the Diffused illumination.
- Cycle Illumination - scanner cycles alternately between direct and indirect illumination. The scanner starts with the illumination used during the last successful decode.



Direct Illumination (0)

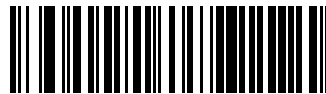

Indirect Illumination (1)



* Cycle Illumination (3)

DPM Mode

Parameter # 1438 (SSI # F8h 05h 9Eh)

Select one of the following DPM modes based on the type of barcode being scanned.



NOTE: DS4678-DP Only.

- Disable DPM Mode - No special processing occurs.
- DPM Mode 1 - Optimizes decoding performance on smaller DPM barcodes, typically found on electronics and medical instruments, especially on smooth surfaces. These barcodes tend to be laser etched or direct-printed.

Notes

If you enable a DPM Mode, disable [Picklist Mode](#) when scanning a DPM barcode. Picklist performance is not guaranteed for DPM barcodes.

If you enable a DPM Mode, the decoder behaves as if the Data Matrix Inverse Autodetect setting is selected. If you disable DPM, the previous (user-selected) Data Matrix Inverse setting remains in effect. See [Data Matrix Inverse](#).



*Disable DPM Mode (0)



Enable DPM Mode (1)

Miscellaneous Scanner Parameters

This section provides additional barcodes and parameters for miscellaneous options.

Enter Key

This parameter adds an Enter key (carriage return or line feed) after scanned data.

To program other prefixes and/or suffixes, see [Prefix/Suffix Values](#).

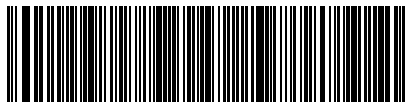

Add Enter Key (Carriage Return/Line Feed)

Tab Key

This parameter adds a Tab key after scanned data.

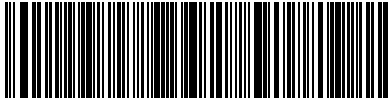

Tab Key

Transmit Code ID Character

Parameter # 45 (SSI # 2Dh)

A Code ID character identifies the code type of a scanned barcode. This is useful when decoding more than one code type. In addition to any single character prefix selected, the Code ID character is inserted between the prefix and the decoded symbol.

Select no Code ID character, a Symbol Code ID character, or an AIM Code ID character. For Code ID characters, see [Symbol Code Identifiers](#) and [AIM Code Identifiers](#).

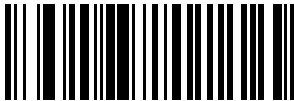

Symbol Code ID Character (2)

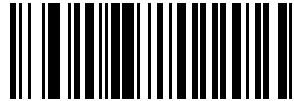

AIM Code ID Character (1)

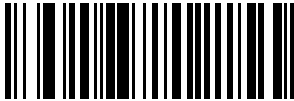

*None (0)

Prefix Suffix Values

Key Category Parameter # P = 99, S1 = 98, S2 = 100

Key Category SSI # P = 63h, S1 = 62h, S2 = 64h

Decimal Value Parameter # P = 105, S1 = 104, S2 = 106

Decimal Value SSI # P = 69h, S1 = 68h, S2 = 6Ah

This parameter appends up to one prefix or up to two suffix values to scan data for use in data editing. The default prefix and suffix value is 7013 <CR><LF> (Enter key).



NOTE: To use Prefix/Suffix values, first set the [Scan Data Transmission Format](#).

To set a value for a prefix or suffix, scan one of the following barcodes, and then scan four barcodes from [Numeric Barcodes](#) that correspond to that value. See [ASCII Character Sets](#) for the four-digit codes.

When using host commands to set the prefix or suffix, set the key category parameter to 1, and then set the 3-digit decimal value. See [ASCII Character Sets](#) for the four-digit codes.

To correct an error or change a selection, scan [Cancel](#).



Scan Prefix (7)



Scan Suffix 1 (6)

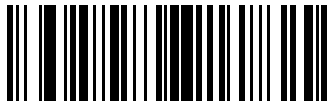

Scan Suffix 2 (8)



Data Format Cancel

Scan Data Transmission Format

Parameter # 235 (SSI # EBh)

This parameter selects the scan data format.



NOTE: If using this parameter do not use ADF rules to set the prefix/suffix.

To set values for the prefix or suffix, see [Prefix Suffix Values](#).

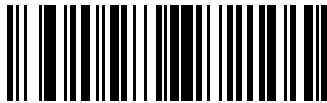

*Data As Is (0)

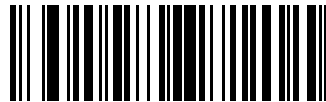

<DATA> <SUFFIX 1> (1)



<DATA> <SUFFIX 2> (2)



<DATA> <SUFFIX 1> <SUFFIX 2> (3)

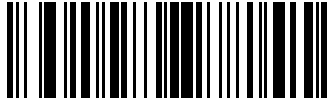

<PREFIX> <DATA > (4)

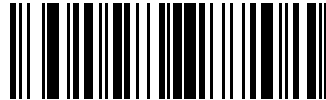

<PREFIX> <DATA> <SUFFIX 1> (5)

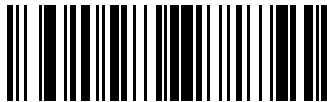

<PREFIX> <DATA> <SUFFIX 2> (6)

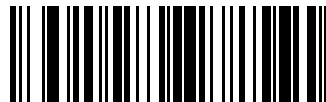

<PREFIX> <DATA> <SUFFIX 1> <SUFFIX 2> (7)

FN1 Substitution Values

Key Category Parameter # 103 (SSI # 67h)

Decimal Value Parameter # 109 (SSI # 6Dh)

Keyboard wedge and USB HID keyboard hosts support a FN1 substitution feature. Enabling this substitutes any FN1 character (0x1b) in an EAN128 barcode with a value. This value defaults to 7013 <CR><LF> (Enter key).

When using host commands to set the FN1 substitution value, set the key category parameter to 1, and then set the 3-digit keystroke value. See the [ASCII Character Sets](#) for the current host interface for the desired value.

Selecting a FN1 Substitution Value

Select a FN1 substitution value via the following barcode menus.

1. Scan the following barcode.

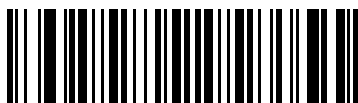

Set FN1 Substitution Value

2. Locate the keystroke desired for FN1 Substitution in the ASCII Character Set table for the current host interface, and enter the 4-digit ASCII value by scanning four barcodes from [Numeric Barcodes](#).

To correct an error or change the selection, scan [Cancel](#).

To enable FN1 substitution for USB HID keyboard, scan the [Enable FN1 Substitution](#) barcode.

Transmit No Read Message

Parameter # 94 (SSI # 5Eh)

This parameter sets an option for transmitting the No Read (NR) characters.



NOTE: If you enable Transmit No Read, and also enable Symbol Code ID Character or AIM Code ID Character for [Transmit Code ID Character](#), the scanner appends the code ID for Code 39 to the NR message.

This does not apply in presentation mode.

- Enable No Read - transmits the characters NR when a successful decode does not occur before trigger release or the [Decode Session Timeout](#) expires.
- Disable No Read - sends nothing to the host if a symbol does not decode.

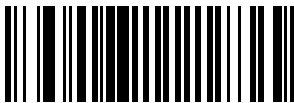

Enable No Read (1)

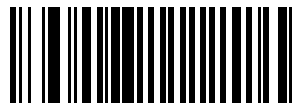

*Disable No Read (0)

Unsolicited Heartbeat Interval

Parameter # 1118 (SSI # F8h 04h 5Eh)

When this parameter is enabled, the scanner can send unsolicited heartbeat messages to assist in diagnostics. The range is 0 - 9999.

The heartbeat event is sent as decode data (with no decode beep) in the form of:

```
MOTEVTHB : nnn
```

Where: nnn is a three-digit sequence number starting at 001 and wrapping after 100.

To enable this parameter and set the desired unsolicited heartbeat interval, scan one of the following time interval barcodes, or scan Set Another Interval followed by four barcodes from [Numeric Barcodes](#) that correspond to the desired number of seconds.

Scan Disable Unsolicited Heartbeat Interval to turn off the feature.

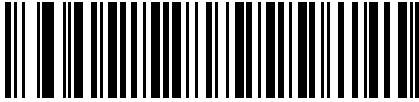

10 Seconds (10)

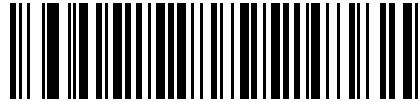

1 Minute (60)

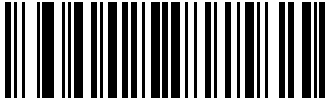

Set Another Interval

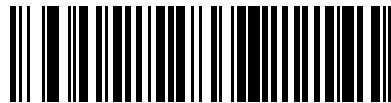

*Disable Unsolicited Heartbeat Interval (0)

securPharm Decoding

Parameter # 1752 (SSI # F8h 06h D8h)

securPharm implements the IFA and GS1 Coding System for the European pharmaceutical industry. securPharm code is used to prevent pharmaceutical counterfeiting. This parameter enables or disables the ability to process pharmaceutical type barcodes.

When this feature is enabled, if a GS1 symbol is decoded and includes any aspects of the Application Identifier associated with the securPharm GS1 specifications, the entire GS1 symbol is processed as a securPharm symbol. For this reason, it is expected that under certain circumstances, a GS1 barcode that is a securPharm symbol may not be processed properly; if the GS1 symbol is not created as per the specification. The output cannot be guaranteed as valid.

Although the GS1-128 type and the GS1 DataBar family are not specifically indicated in the IFA specification, they are supported.

The securPharm output is in XML format and can include the product number, serial number, lot number, expiration and Date of Manufacturing. The XML tags can be arranged in any order. Tags that are not in the barcode are omitted. For example:

```
<content dfi="value_dfi">
  <Daten_1>value_Daten_1</Daten_1>
  <Daten_2>value_Daten_2</Daten_2>
  <Daten_n>value_Daten_n</Daten_n>
</content>
```

Where:

- value_dfi = IFA or GS1
- Daten_1 to Daten_n is the production number, serial number, etc.



*Disable securPharm Decoding (0)



Enable securPharm Decoding (1)

securPharm Output Formatting

Parameter # 1753 (SSI # F8h 06h D9h)

securPharm Output Formatting parameter options represent bit positions. Therefore, any combination of formatting can be used.



NOTE: securPharm output formatting is effective only when [securPharm Decoding](#) is enabled.

When you scan a securPharm Output Formatting barcode, the securPharm output is formatted in a number of ways.

Sample GS1 Format

Product Number: GTIN Data Identifier DI Data Format Identifier: GS1

Data Carrier <i>FNC1</i> 041501 234567 82 101 A234 B5 <i>FNC1</i> 1717 231	
---	---

> Scanned Barcode >

<pre> <content dfi="GS1"> <gtin>04150123456782</gtin> <lot>1A234B5</lot> <exp>151231</exp> <sn>1234567890123456</sn> </content> </pre>
--

Sample GS1 Output - Feature Disabled

The output has no format:

```
0104150123456782101A234B517151231211234567890123456
```

Sample GS1 Output - No Formatting (0)

The output is a single line of characters:

```
<content dfi="GS1"><gtin>04150123456782</gtin><lot>1A234B5</lot><exp>151231</exp><sn>1234567890123456</sn></content>
```

Sample GS1 Output - Insert Tab (1)

The output is a single line of characters with a tab inserted in the XML body:

```
<content dfi="GS1">[tab]<gtin>04150123456782</gtin>[tab]<lot>1A234B5</lot>[tab]<exp>151231</exp>[tab]<sn>1234567890123456</sn></content>
```

Sample GS1 Output - Insert New Line (2)

The output consists of multiple lines of characters with a new line character at the end of each line.

```
<content dfi="GS1">
<gtin>04150123456782</gtin>
<lot>1A234B5</lot>
<exp>151231</exp>
<sn>1234567890123456</sn>
</content>
```

Sample GS1 Output - Insert Tab and New Line (3)

The output consists of multiple lines of characters with tabs and a new line character at the end of each line.

```
<content dfi="GS1">
[tab] <gtin>04150123456782</gtin>
[tab] <lot>1A234B5</lot>
[tab] <exp>151231</exp>
[tab] <sn>1234567890123456</sn>
</content>
```

Sample IFA Format

Product Number: PPN Data Identifier DI Data Format Identifier: IFA

Data Carrier

*Mac06*9N1112 345678 2*Gs*

1T1A234B5*Gs*

D15123 1*Gs*



> Scanned Barcode >

```
<content dfi="IFA ">
<ppn>11 1234567842 </ppn >
<lot>1A 234B5</lot >
<sn>123 4567890123 456</sn >
</content >
```

Sample GS1 Output - Feature Disabled

The output has no format:

```
[ ]>069N1112345678421T1A234B5S1234567890123456
```

Sample GS1 Output - No Formatting (0)

The output is a single line of characters:

```
<content dfi="IFA"><ppn>111234567842</ppn><lot>1A234B5</lot><sn>1234567890123456</sn></content>
```

Sample GS1 Output - Insert Tab (1)

The output is a single line of characters with a tab inserted in the XML body:

```
<content dfi="IFA">[tab]<ppn>111234567842</ppn>[tab]<lot>1A234B5</lot>[tab]<sn>1234567890123456</sn></content>
```

Sample GS1 Output - Insert New Line (2)

The output consists of multiple lines of characters with a new line character at the end of each line.

```
<content dfi="IFA">
<ppn>111234567842</ppn>
<lot>1A234B5</lot>
<sn>1234567890123456</sn>
</content>
```

Sample GS1 Output - Insert Tab and New Line (3)

The output consists of multiple lines of characters with tabs and a new line character at the end of each line.

```
<content dfi="IFA">
[tab] <ppn>111234567842</ppn>
[tab] <ppn>111234567842</ppn>
[tab] <lot>1A234B5</lot>
[tab] <sn>1234567890123456</sn>
</content>
```

securPharm Output Formatting Barcodes

Scan a barcode below to format the securPharm output.



*No Formatting (0)



Insert Tab (1)



Insert New Line (2)



Insert Tab and New Line (3)

Battery Charging User Indication Enhancement

Parameter # 2255 (SSI # F8h 08h CFh)

This parameter determines if the CR8178 cradle LED blinks green or amber (default) when the battery is charging. The LED also blinks green when connected to 123Scan.

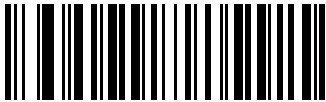

*Blink Amber

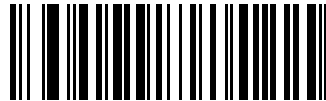

Blink Green

Image Capture Preferences

You can program the imager to perform various functions, or you can activate different features. This section describes image capture preference features and provides programming barcodes for selecting these features.



NOTE: Only the Symbol Native API (SNAPI) with Imaging interface supports image capture. See [USB Device Type](#) to enable this host.

The scanner ships with the settings shown in [Image Capture Preferences Parameter Defaults](#). If the default values suit your requirements, programming is not necessary.

Setting Image Capture Parameters

To set feature values, scan a single barcode or a short barcode sequence. The settings are stored in non-volatile memory and are preserved even when the imager powers down.



NOTE: Most computer monitors allow scanning barcodes directly on the screen. When scanning from the screen, be sure to set the document magnification to a level where you can see the barcode clearly, and bars and/or spaces do not merge.

To return all features to default values, scan the [Default Parameters](#) barcode. Throughout the programming barcode menus, asterisks (*) indicate default values, followed by the feature description and value.

Image Capture Scanning Sequence Examples

You can scan a barcode to set a parameter value.

For example, to disable image capture illumination, scan the Disable Image Capture Illumination barcode found in [Image Capture Illumination](#). After enabling this setting, the imager issues a fast warble beep and the LED turns green, signifying a successful parameter entry.

Other parameters require scanning several barcodes. See the parameter descriptions for this procedure.

Image Capture Errors While Scanning

Unless otherwise specified, to correct an error during a scanning sequence, just re-scan the correct parameter.

Image Capture Preferences Parameter Defaults

The image capture preferences parameter defaults table lists the default values for the DS4678's image capture preference parameters.

You can change values in one of two ways:

- Scan the appropriate barcodes in this section. The new value replaces the standard default value in memory. To recall default parameter values, see [Default Parameters](#).
- Configure the scanner using the 123Scan configuration program. See [123Scan and Software Tools](#).

Table 15 Image Capture Preferences Parameter Defaults

Parameter	Parameter Number ^a	SSI Number ^b	Default
Image Capture Preferences			
Operational Modes	N/A	N/A	N/A
Image Capture Illumination	361	F0h 69h	Enable
Image Capture Autoexposure	360	F0h 68h	Enable
Fixed Exposure	567	F4h F1h 37h	100
Analog Gain	1232	F4h D0h	x2
Digital Gain	1233	F4h D1h	32
Snapshot Mode Timeout	323	F0h 43h	0 (30 seconds)
Snapshot Aiming Pattern	300	F0h 2Ch	Enable
Silence Operational Mode Changes	1293	F8h 05h 0Dh	Disable (do not silence)
Image Cropping	301	F0h 2Dh	Disable
Crop to Pixel Addresses	315	F4h F0h 3Bh	0 top
	316	F4h F0h 3Ch	0 left
	317	F4h F0h 3Dh	799 bottom
	318	F4h F0h 3Eh	1279 right
Image Size (Number of Pixels)	302	F0h 2Eh	Full
Image Brightness (Target White)	390	F0h 86h	180
JPEG Image Options	299	F0h 2Bh	Quality
JPEG Quality Value	305	F0h 31h	65
JPEG Size Value	561	F1h 31h	160 kB
Image Enhancement	564	F1h 34h	Low (1)
Image File Format Selector	304	F0h 30h	JPEG
Image Rotation	665	F1h 99h	0
Bits per Pixel (BPP)	303	F0h 2Fh	8 BPP
Signature Capture	93	5Dh	Disable

Table 15 Image Capture Preferences Parameter Defaults (Continued)

Parameter	Parameter Number ^a	SSI Number ^b	Default
Signature Capture Image File Format Selector	313	F0h 39h	JPEG
Signature Capture Bits per Pixel (BPP)	314	F0h 3Ah	8 BPP
Signature Capture Width	366	F4h F0h 6Eh	400
Signature Capture Height	367	F4h F0h 6Fh	100
Signature Capture JPEG Quality	421	F0h A5h	65

^a Parameter number decimal values are used for programming via RSM commands.

^b SSI number hex values are used for programming via SSI commands.

Image Capture Preferences Modes and Parameters

The parameters in this section control image capture characteristics.

Operational Modes

The scanner can have up to two modes of operation.

- Decode Mode
- Snapshot Mode

Decode Mode

By default, when you press the trigger the imager attempts to locate and decode enabled barcodes within its field of view. The imager remains in this mode until it decodes a barcode or you release the trigger.

Snapshot Mode

Use Snapshot Mode to capture a high-quality image and transmit it to the host. Select the Snapshot Mode option to temporarily enter this mode. While in this mode the imager blinks the green LED at one-second intervals to indicate it is not in standard operating (decode) mode.

In Snapshot Mode, the imager turns on its aiming pattern to highlight the area to capture in the image. The next trigger press instructs the imager to capture a high quality image and transmit it to the host. A short time may pass (less than two seconds) between when the trigger is pressed and the image is captured as the imager adjusts to lighting conditions.

If you do not press the trigger within the Snapshot Mode Timeout period, the imager returns to Decode Mode. Use [Snapshot Mode Timeout](#) to adjust this timeout period. The default timeout period is 30 seconds.

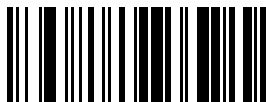

Snapshot Mode

Image Capture Illumination

Parameter # 361 (SSI # F0h 69h)

This parameter turns on illumination during every image capture.

- Enabled - Illumination is on during image capture.
- Disabled - Prevents the imager from using illumination.



NOTE: This usually results in superior images. The effectiveness of illumination decreases as the distance to the target increases.

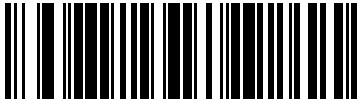

*Enable Image Capture Illumination (1)



Disable Image Capture Illumination (0)

Image Capture Autoexposure

Parameter # 360 (SSI # F0h 68h)

This parameter enables the imager to control gain and exposure (integration time) settings to best capture an image for Snapshot mode.

- Enabled - Allows the imager to control gain and exposure settings to best capture an image.
- Disabled - Manually adjust the gain and exposure time.



NOTE: Disabling Image Capture Autoexposure is only recommended for advanced users with difficult image capture situations.

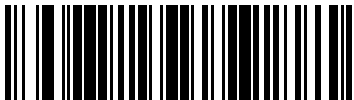

*Enable Image Capture Autoexposure (1)



Disable Image Capture Autoexposure (0)

Fixed Exposure

Parameter # 567 (SSI # F4h F1h 37h)

This parameter configures the exposure used in manual mode for Snapshot and Video modes. Each integer value represents 18.5 microseconds of exposure. The default value is 100 which results in an exposure setting of 10 milliseconds.

Type: Word

Range: 5 - 30,000

To set the exposure, scan the Fixed Exposure barcode, and then scan four numeric barcodes from [Numeric Barcodes](#) representing the value. Leading zeros are required. For example, to set a Fixed Exposure value of 99, scan 0, 0, 9, 9.

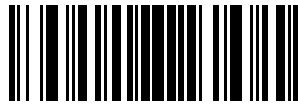

Fixed Exposure (4 digits)

Analog Gain

Parameter # 1232 (SSI # F4h D0h)

This parameter sets the analog gain value.



Analog Gain x 1 (0)

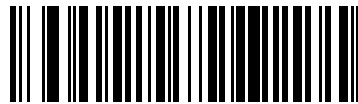

*Analog Gain x 2 (1)



Analog Gain x 4 (2)

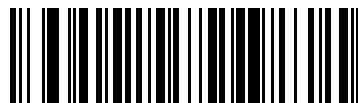

Analog Gain x 8 (3)

Digital Gain

Parameter # 1233 (SSI # F4h D1h)

This parameter adjusts the digital gain.

A value of 32 = x 1 digital gain; i.e., digital gain = 1/32 x digital gain parameter value.

Scan digital gain, and then scan two barcodes from [Numeric Barcodes](#) to enter a 2-digit value for the digital gain. The default is 32.

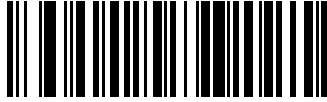

Digital Gain

Snapshot Mode Timeout

Parameter # 323 (SSI # F0h 43h)

This parameter sets the amount of time the imager remains in Snapshot Mode.

- Set Snapshot Mode Timeout - scan this parameter and then scan a barcode from [Numeric Barcodes](#). Values increment by 30. For example, 1 = 60 seconds, 2 = 90 seconds.
- 30 Seconds - resets timeout to 30 seconds.
- No Timeout - the imager remains in Snapshot Mode until you press the trigger.

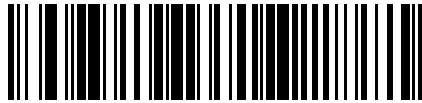

Set Snapshot Mode Timeout



*30 Seconds

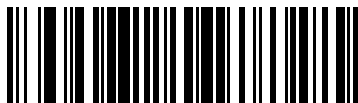

No Timeout

Snapshot Aiming Pattern

Parameter # 300 (SSI # F0h 2Ch)

This parameter determines whether or not to project the aiming pattern when in Snapshot Mode.

- Enabled - The aiming pattern frames the image for aiming purposes and does not appear in the captured image.
- Disabled - The aiming pattern does not frame the image for aiming purposes.



*Enable Snapshot Aiming Pattern (1)

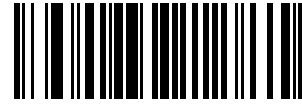

Disable Snapshot Aiming Pattern (0)

Silence Operational Mode Changes

Parameter # 1293 (SSI # F8h 05h 0Dh)

This parameter silences the beeper when switching between operational modes (for example, from Decode Mode to Snapshot Mode).

- Enabled - Silences the beep when switching between operational modes.
- Disabled - Allows the beep when switching between operational modes.



Silence Operational Mode Changes (Enable) (1)



*Do Not Silence Operational Mode Changes (Disable) (0)

Image Cropping

Parameter # 301 (SSI # F0h 2Dh)

This parameter crops a captured image to the pixel addresses set in Crop to Pixel Addresses.

- Enabled - Crops the captured image.
- Disabled - Does not crop the captured image.

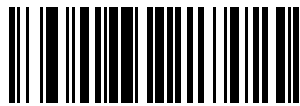

Enable Image Cropping (1)

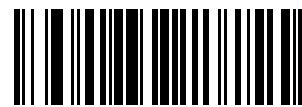

*Disable Image Cropping (Use Full 1280 x 960 Pixels) (0)

Crop to Pixel Addresses

Parameter # 315 (SSI # F4h F0h 3Bh) (Top)

Parameter # 316 (SSI # F4h F0h 3Ch) (Left)

Parameter # 317 (SSI # F4h F0h 3Dh) (Bottom)

Parameter # 318 (SSI # F4h F0h 3Eh) (Right)

When Image Cropping is enabled, use this parameter to set the pixel addresses.

The pixel addresses value range is (0,0) to 1279 x 959.

- Top Pixel Address - A value with the left pixel address to begin an image crop.
- Left Pixel Address - A value with the top pixel address to begin an image crop.
- Right Pixel Address - A value with the right pixel address to end an image crop.
- Bottom Pixel Address - A value with the right pixel address to end an image crop.

Columns are numbered from 0 to 1279, rows from 0 to 959. Specify values for Top, Left, Bottom, and Right, where Top and Bottom correspond to row pixel addresses, and Left and Right correspond to column pixel addresses.



NOTE: The imager has a cropping resolution of 4 pixels. Setting the cropping area to less than 4 pixels (after resolution adjustment, see [Image Size](#)) transfers the entire image.

To crop to the pixel addresses, enable Image Cropping, and then scan four numeric barcodes from [Numeric Barcodes](#) representing the value.

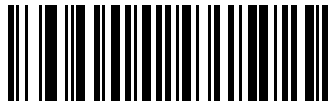

Top Pixel Address (0 - 959 Decimal)

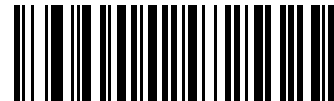

Left Pixel Address (0 - 1279 Decimal)



Bottom Pixel Address (0 - 959 Decimal)



Right Pixel Address (0 - 1279 Decimal)

Image Size (Number of Pixels)

Parameter # 302 (SSI # F0h 2Eh)

This option alters image resolution before compression. Multiple pixels are combined into one pixel, resulting in a smaller image containing the original content with reduced resolution.

Select a resolution value to produce an image size.

Table 16 Image Size

Resolution Value	Uncropped Image Size
Full	1280 x 800
1/2	640 x 400
1/4	320 x 200

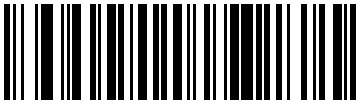

*Full Resolution (0)



1/2 Resolution (1)

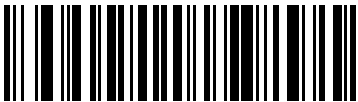

1/4 Resolution (3)

Image Brightness (Target White)

Parameter # 390 (SSI # F0h 86h)

This parameter sets the Target White value used in Snapshot and Video Viewfinder modes when using auto exposure.

Type: Byte

Range: 1 - 240

- Image Brightness (3 digits) - Represents the image brightness value.
- 180 - Sets the white level of the image to ~180.



NOTE: White and black are defined as the maximum value decimal and 1, respectively.

Scan Image Brightness, and then scan three numeric barcodes from Numeric Barcodes representing the value. Leading zeros are required. For example, to set an Image Brightness value of 99, scan 0, 9, 9.

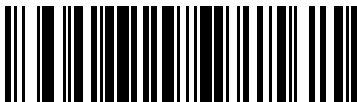

*180

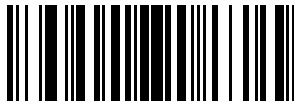

Image Brightness (3 digits)

JPEG Image Options

Parameter # 299 (SSI # F0h 2Bh)

This parameter changes the JPEG image quality or size.

- JPEG Quality Selector - Enter a quality value via the [JPEG Quality Value](#) parameter; the imager then selects the corresponding image size.
- JPEG Size Selector - Enter a size value via the [JPEG Size Value](#) parameter; the imager then selects the best image quality.

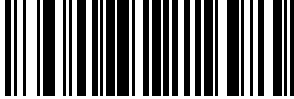

*JPEG Quality Selector (1)



JPEG Size Selector (0)

JPEG Quality Value

Parameter # 305 (SSI # F0h 31h)

This parameter adjusts the quality of the JPEG.



NOTE: Use this parameter if you selected JPEG Quality Selector as a JPEG Image Option.

Scan the JPEG Quality Value, and then scan three barcodes from [Numeric Barcodes](#) corresponding to a value from 5 to 100, where 100 represents the highest quality image. Leading zeros are required. For example, to set an image quality value of 55, scan 0, 5, 5.



JPEG Quality Value (Default: 065) (5 - 100 Decimal)

JPEG Size Value

Parameter # 561 (SSI # F1h 31h)

Type: Word

Range: 5-350

If you selected JPEG Size Selector, use JPEG Size Value to set the JPEG size.



CAUTION: JPEG compression may take 10 to 15 seconds based on the amount of information in the target image. Selecting [JPEG Quality Selector](#) produces a compressed image that is consistent in quality and compression time.

To set the JPEG size, scan JPEG Size Value and then scan three numeric barcodes from [Numeric Barcodes](#) representing the target JPEG file size in kilobytes (KB). Leading zeros are required. For example, to set an image file size value of 99, scan 0, 9, 9.

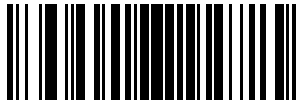

JPEG Size Value (Default: 160) (3 digits)

Image Enhancement

Parameter # 564 (SSI # F1h 34h)

This parameter uses a combination of edge sharpening and contrast enhancement to produce an image that is visually pleasing.

Select the level of image enhancement:

- Off (0)
- Low (1)
- Medium (2)
- High (3)

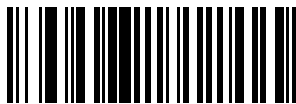

Off (0)

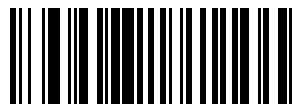

*Low (1)



Medium (2)

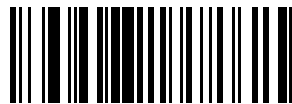

High (3)

Image File Format Selector

Parameter # 304 (SSI # F0h 30h)

Image Capture Preferences

Use this parameter to select an image format appropriate for the system (BMP, TIFF, or JPEG). The imager stores captured images in the selected format.



BMP File Format (3)



*JPEG File Format (1)

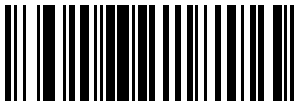

TIFF File Format (4)

Image Rotation

Parameter # 665 (SSI # F1h 99h)

Use this parameter to rotate an image by 90-degree increments (0, 90, 180, or 270).

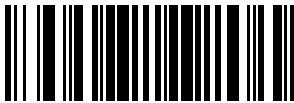

*Rotate 0° (0)

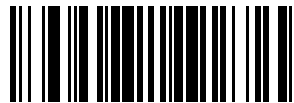

Rotate 90° (1)

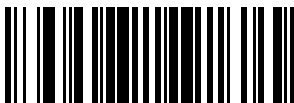

Rotate 180° (2)

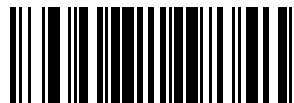

Rotate 270° (3)

Bits Per Pixel

Parameter # 303 (SSI # F0h 2Fh)

Use this parameter to select the number of significant bits per pixel (BPP) to use when capturing an image.

- 1 BPP - For a black and white image.

- 4 BPP - Assigns 1 of 16 levels of grey to each pixel.
- 8 BPP - Assigns 1 of 256 levels of grey to each pixel.



NOTE: The imager ignores these settings for JPEG file formats, which only support 8 BPP. TIFF file formats only support 4 BPP and 8 BPP. Selecting **1 BPP** for TIFF applies the 4 BPP option.



1 BPP (0)



4 BPP (1)

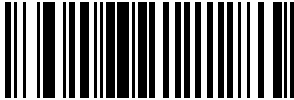

*8 BPP (2)

Signature Capture

Parameter # 93 (SSI # 5Dh)

Signature capture is a special-purpose symbology that delineates a signature capture area in a document with a machine-readable format.

Output File Format

- Enabled - Signature capture is available.
- Disabled - Signature capture is not available.

The recognition pattern is variable so it can optionally provide an index to various signatures. The region inside the barcode pattern is considered the signature capture area. See [Signature Capture Code](#) for more information.

Decoding a signature capture barcode de-skews the signature image and converts the image to a BMP, JPEG, or TIFF file format. The output data includes the file descriptor followed by the formatted signature image.

Table 17 Output File Format

Output Format (1 byte)	File Descriptor		Signature Image
	Signature Type (1 byte)	Signature Image Size (4 bytes) (BIG Endian)	
JPEG - 1	1-8	0x00000400	0x00010203....
BMP - 3			
TIFF - 4			



Enable Signature Capture (1)

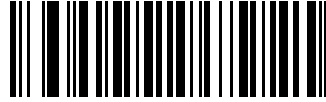

*Disable Signature Capture (0)

Signature Capture File Format Selector

Parameter # 313 (SSI # F0h 39h)

This parameter de-skews the signature image and converts the image to a BMP, JPEG, or TIFF file format.

Select a signature file format appropriate for the system (BMP, TIFF, or JPEG). The imager stores captured signatures in the selected format.

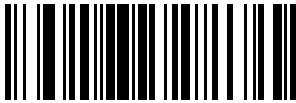

BMP Signature Format (3)

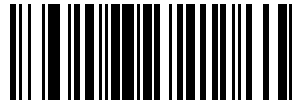

*JPEG Signature Format (1)

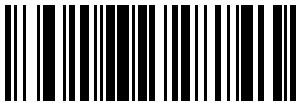

TIFF Signature Format (4)

Signature Capture Bits Per Pixel

Parameter # 314 (SSI # F0h 3Ah)

You can adjust the bits per pixel (BPP) when capturing a signature.

Select the number of significant bits per pixel (BPP) to use when capturing a signature:

- 1 BPP - For a black and white image.
- 4 BPP - Assigns 1 of 16 levels of grey to each pixel.
- 8 BPP - Assigns 1 of 256 levels of grey to each pixel.



NOTE: The imager ignores these settings for JPEG file formats, which only support 8 BPP.

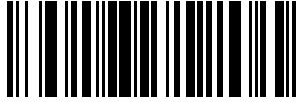

1 BPP (0)



4 BPP (1)

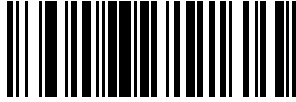

*8 BPP (2)

Signature Capture Width

Parameter # 366 (SSI # F4h F0h 6Eh)

This parameter adjusts the width of a signature capture box.



NOTE: The aspect ratio of the Signature Capture Width and Signature Capture Height parameters must match that of the signature capture area. For example, a 4 x 1 inch signature capture area requires a 4 to 1 aspect ratio of width to height.

To set the width of the signature capture box, scan Signature Capture Width, and then scan four barcodes from [Numeric Barcodes](#) corresponding to a value in the range of 001 to 1280 decimal.



Signature Capture Width (Default: 400) (001 - 1280
Decimal)

Signature Capture Height

Parameter # 367 (SSI # F4h F0h 6Fh)

This parameter adjusts the height of a signature capture box.

To set the height of the signature capture box, scan Signature Capture Height, and then scan three barcodes from [Numeric Barcodes](#) corresponding to a value in the range of 001 to 800 decimal.



Signature Capture Height (Default: 100) (001 - 800
Decimal)

Signature Capture JPEG Quality

Parameter # 421 (SSI # F0h A5h)

This parameter adjusts the image quality for a signature capture JPEG.

Scan JPEG Quality Value, and then scan three barcodes from [Numeric Barcodes](#) corresponding to a value from 005 to 100, where 100 represents the highest quality image.



JPEG Quality Value (Default: 065) (5 - 100 Decimal)

USB Interface

This section describes how to set up the scanner with a USB host. The scanner connects directly to a USB host, or a powered USB hub, which powers it.

The scanner ships with the settings shown in [USB Parameter Defaults](#). If the default values suit requirements, programming is not necessary.

USB Interface Connection

Connect the scanner directly to the host computer.

Figure 8 USB Connection

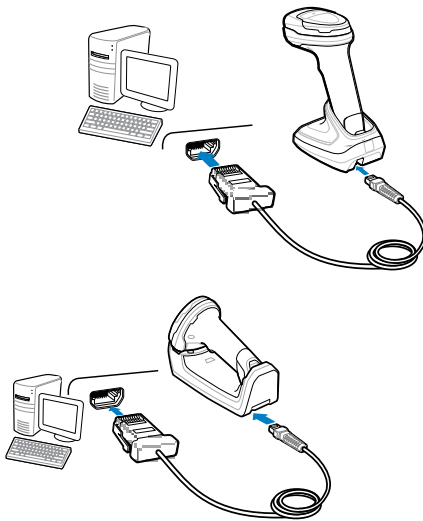

NOTE: When connecting via USB use the shielded connector cable (e.g., p/n CBA-U21-S07ZAR). Refer to Solution Pathways for guidance about cables.

The scanner connects to USB-capable hosts including:

- TGCS (IBM) terminals
- Apple™ desktop and notebooks
- Other network computers that support more than one keyboard.

The following operating systems support the scanner through USB:

- Windows® XP, 7, 8, 10
- MacOS 8.5 - MacOS 10.6
- TGCS (IBM) 4690/TCx Sky OS

The scanner also interfaces with other USB hosts that support USB Human Interface Devices (HID).

Connecting a USB Interface

You can connect a device by a USB interface cable.



NOTE: Interface cables vary depending on configuration. Any connectors illustrated are examples only. While connectors might be different than those illustrated, the steps to connect the scanner are the same.

1. Connect the modular connector of the USB interface cable to the cable interface port on the scanner. .
2. Plug the series A connector in the USB host or hub, or plug the Plus Power connector in an available port of the IBM SurePOS terminal.
3. If applicable, connect a power supply between the power port on the interface cable and an AC outlet.
4. The scanner automatically detects the host and uses the #default USB device type. If the default (*) does not meet your requirements, #select another USB device type by scanning the appropriate barcode from [USB Device Type](#).
5. On first installation when using Windows, the software may prompt to select or install the Human Interface Device driver. To install this driver, provided by Windows, click Next at all choices and click Finished on the last choice. The scanner powers up during this installation.
6. To modify any other parameter options, scan the appropriate barcodes in this section.

If problems occur with the system, see [Troubleshooting](#).

USB Parameter Defaults

The following table lists defaults for USB host parameters. You can change default values in one of two ways:

- Scan the appropriate barcodes in this section. The new value replaces the standard default value in memory. To recall default parameter values, see [Default Parameters](#).
- Configure the scanner using the 123Scan configuration program. See [123Scan and Software Tools](#).

Table 18 USB Interface Parameter Defaults

Parameter	Default
USB Host Parameters	
USB Device Type	HID Keyboard Emulation
USB CDC Host Variant	Standard
Symbol Native API (SNAPI) Status Handshaking	Enable
USB Keystroke Delay	No Delay

Table 18 USB Interface Parameter Defaults (Continued)

Parameter	Default
USB Caps Lock Override	Do Not Override Caps Lock Key (Disable)
Barcodes with Unknown Characters	Send Barcodes with Unknown Characters
USB Convert Unknown to Code 39	Disable
USB Fast HID	Enable
USB Polling Interval	3 msec
Keypad Emulation	Enable
Quick Keypad Emulation	Enable
Keypad Emulation with Leading Zero	Enable
USB Keyboard FN1 Substitution	Disable
Function Key Mapping	Disable
Simulated Caps Lock	Disable
Convert Case	No Case Conversion
USB Static CDC	Enable
TGCS (IBM) USB Direct I/O Beep	Honor
TGCS (IBM) USB Beep Directive	Ignore
TGCS (IBM) USB Barcode Configuration Directive	Ignore
TGCS (IBM) USB Specification Version	Version 2.2
Product ID (PID) Type	Host Type Unique
Product ID (PID) Value	None
ECLevel	None

USB Host Parameters

Scan barcodes to set USB host parameters.

USB Device Type

- When changing USB device types, the scanner resets and issues the standard startup beep sequences.
- When connecting two scanners to a host, IBM does not allow selecting two of the same device type. If you require two connections, select an IBM Table-top USB for one scanner and an IBM Hand-held USB for the second scanner.
- Select OPOS (IBM Hand-held with Full Disable) to completely shut off the scanner when an IBM register issues a Scan Disable command, including aim, illumination, decoding, and data transmission.

USB Interface

- Before selecting USB CDC Host, ensure your host OS has a USB CDC driver installed. For reference, Windows 10 includes a native (built-in) USB CDC driver. To recover a scanner stalled (non-functional) in USB CDC mode:
 - Install a USB CDC Driver
- Select USB HID POS to communicate over a USB cable with Microsoft's Universal Windows Platform (UWP) applications running on Windows 10 devices.



*USB HID Keyboard



IBM Table-top USB

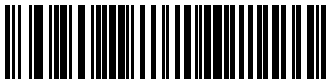

IBM Hand-held USB



OPOS (IBM Hand-held with Full Disable)



USB CDC Host



SSI over USB CDC



Symbol Native API (SNAPI) with Imaging Interface



Symbol Native API (SNAPI) without Imaging Interface



USB HID POS (Windows 10 devices only)

USB CDC Host Variant

Parameter # 1713

When USB Device Type is set to USB CDC Host, the CDC Host Variant selects which type of CDC variant is used. The default USB CDC host variant is Standard CDC Host Mode.

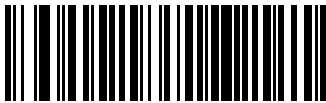

*Standard USB CDC (0)



Datalogic USB CDC Host Variant (10)

Symbol Native API (SNAPI) Status Handshaking

After selecting a SNAPI interface as the USB device type, select an option to enable or disable status handshaking.

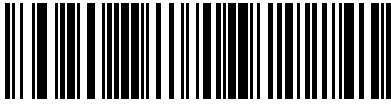

*Enable SNAPI Status Handshaking

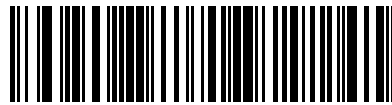

Disable SNAPI Status Handshaking

USB Keystroke Delay

This parameter sets the delay, in milliseconds, between emulated keystrokes. Select a longer delay for hosts that require slower data transmission.



*No Delay

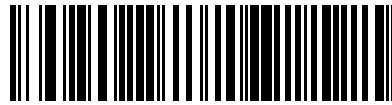

Medium Delay (20 msec)



Long Delay (40 msec)

USB Caps Lock Override

This option applies only to the USB HID Keyboard device. Select Override Caps Lock Key to preserve the case of the data regardless of the state of the Caps Lock key. This setting is always enabled for the Japanese Windows (ASCII) keyboard type and cannot be disabled.

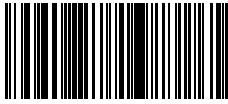

Override Caps Lock Key (Enable)



*Do Not Override Caps Lock Key (Disable)

USB Barcodes with Unknown Characters

This option applies only to the USB HID Keyboard and IBM devices. Unknown characters are characters the host does not recognize. Select Send Barcodes With Unknown Characters to send all barcode data except for unknown characters. The scanner issues no error beeps.

Select Do Not Send Barcodes With Unknown Characters for IBM devices to prevent sending barcodes containing at least one unknown character to the host, or for USB HID Keyboard devices to send the barcode characters up to the unknown character. The scanner issues an error beep.

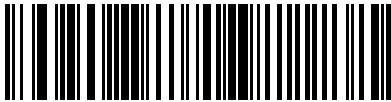

*Send Barcodes with Unknown Characters

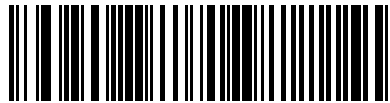

Do Not Send Barcodes with Unknown Characters

USB Convert Unknown to Code 39

This option applies only to the IBM hand-held, IBM table-top, and OPOS devices. Select an option to enable or disable converting unknown barcode type data to Code 39.

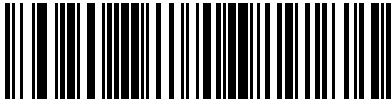

Enable Convert Unknown to Code 39

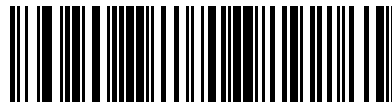

*Disable Convert Unknown to Code 39

USB Fast HID

Select Enable USB Fast HID to transmit USB HID data at a faster rate.



NOTE: Disable this if there are problems with transmission.

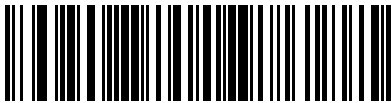

*Enable USB Fast HID

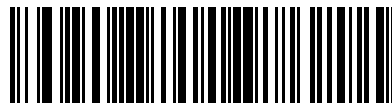

Disable USB Fast HID

USB Polling Interval

Select an option to set the polling interval, which is the rate at which data transmits between the scanner and host computer. A lower number indicates a faster data rate.



NOTE: When changing the USB polling interval, the scanner restarts and issues a power-up beep sequence.



IMPORTANT: Ensure the host supports the selected data rate.



1 msec



2 msec



*3 msec



4 msec

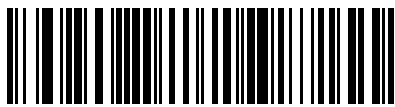

5 msec



6 msec

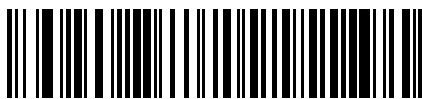

7 msec



8 msec



9 msec

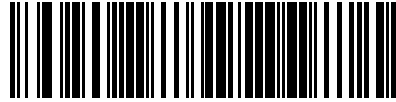

10 msec

Keypad Emulation

Select Enable Keypad Emulation to send all characters as ASCII sequences over the numeric keypad. For example, ASCII A transmits as “ALT make” 0 6 5 “ALT Break”.



NOTE: If your keyboard type is not listed in the country code list (see [Country Codes](#)), disable [Quick Keypad Emulation](#) and enable Keypad Emulation.



*Enable Keypad Emulation

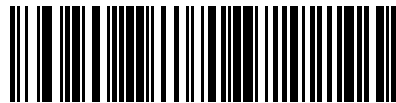

Disable Keypad Emulation

USB Quick Keypad Emulation

Enable Quick Keypad Emulation for a quick method of emulation using the numeric keypad where ASCII sequences are only sent for ASCII characters not found on the keyboard.



NOTE: Quick Keypad Emulation only applies to the USB HID Keyboard device when Keypad Emulation is enabled.



*Enable Quick Keypad Emulation

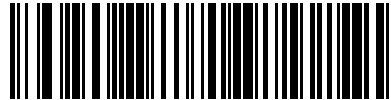

Disable Quick Keypad Emulation

Keypad Emulation with Leading Zero

Select Enable Keypad Emulation with Leading Zero to send character sequences sent over the numeric keypad as ISO characters which have a leading zero. For example, ASCII A transmits as “ALT MAKE” 0 0 6 5 “ALT BREAK”.



NOTE: This parameter only applies if [Emulate Keypad](#) is enabled.

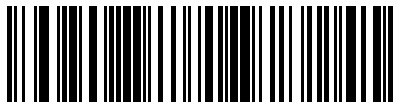

*Enable Keypad Emulation with Leading Zero



Disable Keypad Emulation with Leading Zero

USB Keyboard FN1 Substitution

This option applies code 128 and ISBT 128 to the USB HID Keyboard device. Scan Enable USB Keyboard FN1 Substitution to replace any FN1 character in a GS1 128 barcode with a user-selected Key Category and value.

See [FN1 Substitution Values](#) to set the Key Category and Key Value.

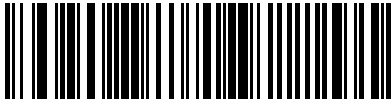

Enable USB Keyboard FN1 Substitution

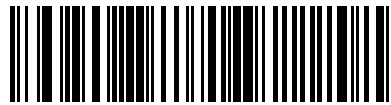

*Disable USB Keyboard FN1 Substitution

USB Function Key Mapping

ASCII values under 32 are normally sent as a control-key sequence (see [ASCII Character Sets](#)). Select Enable Function Key Mapping to send the keys in bold instead of the standard key mapping. Table entries that do not have a bold equivalent remain the same regardless of whether you enable this parameter.

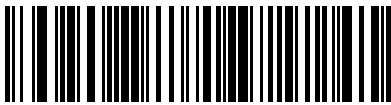

Enable Function Key Mapping



*Disable Function Key Mapping

USB Simulated Caps Lock

Select Enable Simulated Caps Lock to invert upper and lower case characters on the barcode as if the Caps Lock state is enabled on the keyboard. This inversion occurs regardless of the keyboard's Caps Lock state.



NOTE: Simulated Caps Lock applies to ASCII characters only. Do not enable this if [Caps Lock Override](#) is enabled.

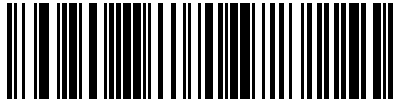

Enable Simulated Caps Lock

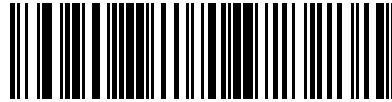

*Disable Simulated Caps Lock

USB Convert Case

Use this parameter to convert all of the barcode data to the selected case.



NOTE: Convert Case applies to ASCII characters only.

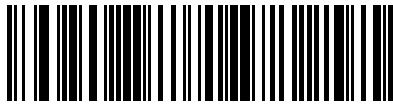

*No Case Conversion

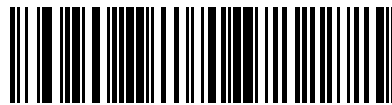

Convert All to Upper Case

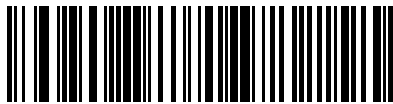

Convert All to Lower Case

USB Static CDC

Parameter # 670

You can connect devices to the same COM port or different COM ports.

When disabled, each device connected consumes another COM port (first device = COM1, second device = COM2, third device = COM3, etc.)

When enabled, each device connects to the same COM port.



*Enable USB Static CDC (1)

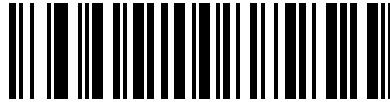

Disable USB Static CDC (0)

TGCS (IBM) USB Direct I/O Beep

Parameter # 1360

The host can send a direct I/O beep request to the scanner. If you select Ignore Direct I/O Beep, the scanner does not sound beeps on this command. All directives are still acknowledged to the USB host as if they were processed.



Honor Direct I/O Beep



Ignore Direct I/O Beep

TGCS (IBM) USB Beep Directive

The host can send a beeper configuration request to the scanner. Scan Ignore Beep Directive to prevent the scanner from processing the host request. All directives are still acknowledged to the USB host as if they were processed.



Honor Beep Directive



*Ignore Beep Directive

TGCS (IBM) USB Barcode Configuration Directive

The host can enable and disable code types. Scan Ignore Barcode Configuration Directive to prevent the scanner from processing the host request. All directives are still acknowledged to the USB host as if they were processed.



Honor Barcode Configuration Directive



*Ignore Barcode Configuration Directive

TGCS (IBM) USB Specification Version

Parameter # 1729

You can specify code types as unknown or specify the code types with an appropriate IBM identifier.

Select IBM Specification Level (Original) to send the following code types as Unknown:

- Data Matrix
- GS1 Data Matrix
- QR Code
- GS1 QR
- MicroQR Code
- Aztec

Select IBM Specification Level Version 2.2 to send the code types with the appropriate IBM identifiers.



IBM Specification Level (Original)



IBM Specification Level Version 2.2 or higher

Product ID (PID) Type

Parameter # 1281 (SSI # F8h 05h 01h)

This parameter defines the PID value reported in USB enumeration.



*Host Type Unique (0)



Product Unique (1)



IBM Unique (2)

Product ID (PID) Value

Parameter # 1725 (SSI # F8h 06h BDh)

This parameter sets a Product ID (PID) value.



NOTE: This parameter applies to customers using a Firmware Flash Update per the Toshiba Global Commerce Solutions (TGCS) Universal Serial Bus OEM Point-of-Sale Device Interface.

To set a Product ID value, scan Set PID Value, and then scan four numeric barcodes in [Numeric Barcodes](#) that correspond to the value. Enter a leading zero for single-digit numbers. To correct an error, or change a selection, scan [Cancel](#). The range is (0, 1600 - 1649).



Set PID Value

ECLevel

Parameter # 1710 (SSI # F8h 06h AEh)

This parameter sets an ECLevel.



NOTE: This parameter applies to customers using a Firmware Flash Update per the Toshiba Global Commerce Solutions (TGCS) Universal Serial Bus OEM Point-of-Sale Device Interface. It allows defining an ECLevel value to manage and control Flash Update operations on the 4690 operating system.

Contact Zebra Support at zebra.com/support for more information.

To set an ECLevel value, scan Set ECLevel, and then scan five numeric barcodes in [Numeric Barcodes](#) that correspond to the desired level. Enter a leading zero for single digit numbers. To correct an error, or change a selection, scan [Cancel](#).

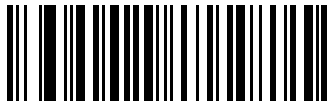

Set ECLevel

USB ASCII Character Sets

See [ASCII Character Sets](#) for the following information:

- [ASCII Character Sets](#)
- [ALT Key Character Set](#)
- [GUI Key Character Set](#)
- [F Key Character Set](#)

SSI Interface

This section describes the system requirements of the Simple Serial Interface (SSI), which provides a communications link between Zebra decoders (e.g., scan engines, slot scanners, hand-held scanners, two-dimensional scanners, hands-free scanners, and RF base stations) and a serial host. It provides the means for the host to control the decoder or scanner.

Communication

All communication between the scanner and host occurs over the hardware interface lines using the SSI protocol. Refer to the Simple Serial Interface Programmer's Guide, p/n 72E-40451-xx, for more information on SSI.

The host and the scanner exchange messages in packets. A packet is a collection of bytes framed by the proper SSI protocol formatting bytes. The maximum number of bytes per packet that the SSI protocol allows for any transaction is 257 (255 bytes + 2 byte checksum).

Depending on the configuration, the scanner can send decode data as ASCII data (unpacked), or as part of a larger message (packeted).

SSI performs the following functions for the host device:

- Maintains a bi-directional interface with the scanner
- Allows the host to send commands that control the scanner
- Passes data from the scanner to a host device in SSI packet format or straight decode message.

The SSI environment consists of a scanner, a serial cable which attaches to the host device, and if required, a power supply.

SSI transmits all decode data including special formatting (for example, AIM ID). Parameter settings can control the format of the transmitted data.

The scanner can also send parameter information, product identification information, or event codes to the host.

All commands sent between the scanner and host must use the format described in the SSI Message Formats section. [SSI Transactions](#) describes the required sequence of messages in specific cases.

SSI Commands

The following table lists all the SSI opcodes the scanner supports. The host transmits opcodes designated type H. The scanner (decoder) transmits type D opcodes and transmits Host/Decoder (H/D) types.

Table 19 SSI Commands

Name	Type	Opcode	Description
AIM_OFF	H	0xC4	Deactivate aiming pattern.
AIM_ON	H	0xC5	Activate aiming pattern.
BEEP	H	0xE6	Sound the beeper.
CAPABILITIES_REPLY	D	0xD4	Reply to CAPABILITIES_REQUEST; contains a list of the capabilities and commands the decoder supports.
CAPABILITIES_REQUEST	H	0xD3	Request capabilities report from the decoder.
CMD_ACK	H/D	0xD0	Positive acknowledgment of received packet.
CMD_NAK	H/D	0xD1	Negative acknowledgment of received packet.
DECODE_DATA	D	0xF3	Decode data in SSI packet format.
EVENT	D	0xF6	Event indicated by associated event code.
LED_OFF	H	0xE8	De-activate LED output.
LED_ON	H	0xE7	Activate LED output.
PARAM_DEFAULTS	H	0xC8	Set parameter default values.
PARAM_REQUEST	H	0xC7	Request values of certain parameters.
PARAM_SEND	H/D	0xC6	Send parameter values.
REPLY_REVISION	D	0xA4	Reply to REQUEST_REVISION, contains the decoder's software/hardware configuration.
REQUEST_REVISION	H	0xA3	Request the decoder's configuration.
SCAN_DISABLE	H	0xEA	Prevent the operator from scanning barcodes.
SCAN_ENABLE	H	0xE9	Permit barcode scanning.
SLEEP	H	0xEB	Request to place the decoder into low power.
START_DECODE	H	0xE4	Tell the decoder to attempt to decode a barcode.
STOP_DECODE	H	0xE5	Tell the decoder to abort a decode attempt.
WAKEUP	H	N/A	Wake the decoder from low power mode.

For details of the SSI protocol, refer to the Simple Serial Interface Programmer's Guide.

SSI Transactions

General Data Transactions

This section describes general data transactions between the scanner and a host.

ACK/NAK Handshaking

If you enable ACK/NAK handshaking (the default), all packeted messages must have a CMD_ACK or CMD_NAK response, unless the command description states otherwise. Zebra recommends leaving this

handshaking enabled to provide feedback to the host. Raw decode data and WAKEUP do not use ACK/NAK handshaking since they are not packeted data.

Following is an example of a problem which can occur if you disable ACK/NAK handshaking:

- The host sends a PARAM_SEND message to the scanner to change the baud rate from 9600 to 19200.
- The scanner cannot interpret the message.
- The scanner does not implement the change the host requested.
- The host assumes that the parameter change occurred and acts accordingly.
- Communication is lost because the change did not occur on both sides.

If you enable ACK/NAK handshaking, the following occurs:

- The host sends a PARAM_SEND message.
- The scanner cannot interpret the message.
- The scanner CMD_NAKs the message.
- The host resends the message.
- The scanner receives the message successfully, responds with CMD_ACK, and implements parameter changes.

Decoded Data Transmission

The [Decode Data Packet Format](#) parameter controls how decode data is sent to the host. Set this parameter to send the data in a DECODE_DATA packet. Clear this parameter to transmit the data as raw ASCII data.



NOTE: When transmitting decode data as raw ASCII data, ACK/NAK handshaking does not apply regardless of the state of the ACK/NAK handshaking parameter.

ACK/NAK Enabled and Packeted Data

The scanner sends a DECODE_DATA message after a successful decode. The scanner waits for a programmable timeout for a CMD_ACK response. If it does not receive the response, the scanner tries to send two more times before issuing a host transmission error. If the scanner receives a CMD_NAK from the host, it may attempt a retry depending on the cause field of the CMD_NAK message.

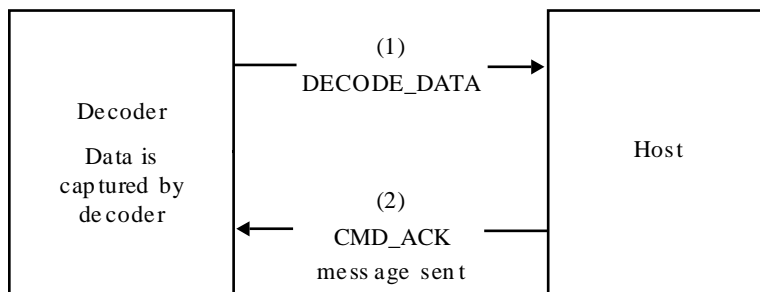

ACK/NAK Enabled and Unpacketed ASCII Data

Even if ACK/NAK handshaking is enabled, no handshaking occurs because handshaking applies only to packeted data. In this example the packeted_decode parameter is disabled.

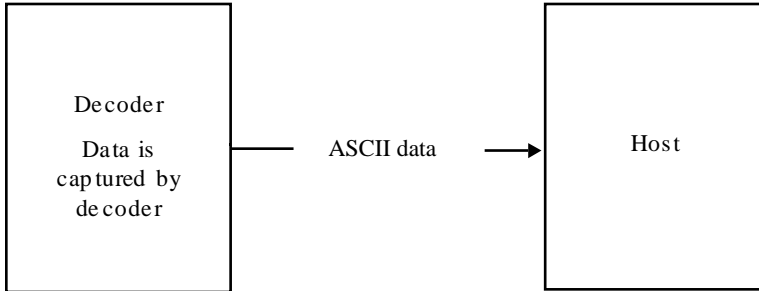

ACK/NAK Disabled and Packeted DECODE_DATA

In this example ACK/NAK does not occur even though packeted_decode is enabled because the ACK/NAK handshaking parameter is disabled.

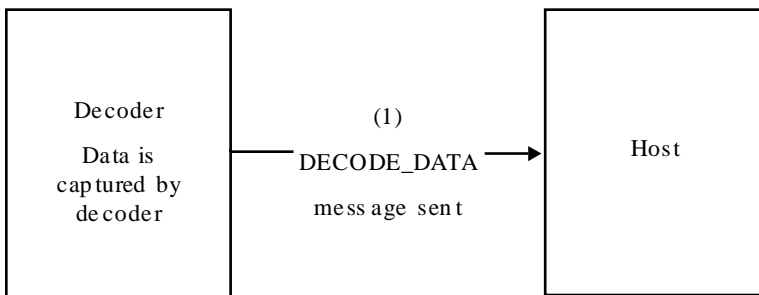

ACK/NAK Disabled and Unpacketed ASCII Data

The decoder sends captured data to the host.

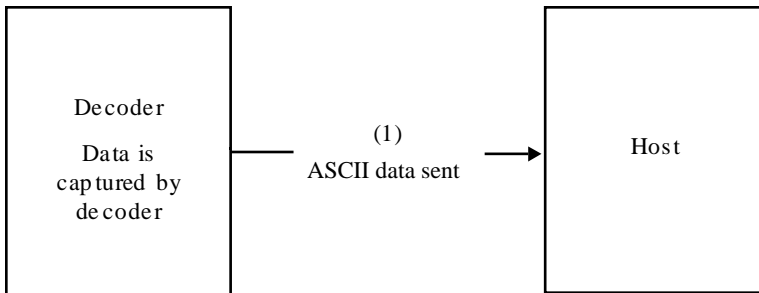

Communication Summary

RTS/CTS Lines

All communication must use RTS/CTS handshaking as described in the Simple Serial Interface Programmer's Guide, p/n 72E-40451-xx. If bypassing hardware handshaking, the host must send the WAKEUP command before all other communication or the first byte of a message can be lost during the scanner wakeup sequence. Zebra recommends not bypassing RTS/CTS hardware handshaking.

ACK/NAK Option

ACK/NAK handshaking is enabled by default and Zebra recommends leaving it enabled. Disabling this can cause communication problems, as handshaking is the only acknowledgment that a message was received correctly. ACK/NAK is not used with unpacketed decode data regardless of whether it is enabled.

Number of Data Bits

All communication with the scanner must use 8-bit data.

Serial Response Timeout

The [Host Serial Response Timeout](#) parameter determines how long to wait for a handshaking response before trying again or aborting further attempts. Set the same value for both the host and scanner.



NOTE: You can temporarily change the [Host Serial Response Timeout](#) when the host takes longer to process an ACK or longer data string. Zebra does not recommend frequent permanent changes due to limited write cycles of non-volatile memory.

Retries

The host resends data twice after the initial send if the scanner does not respond with an ACK or NAK (if ACK/NAK handshaking is enabled), or response data (for example, PARAM_SEND, REPLY_REVISION). If the scanner replies with a NAK RESEND, the host resends the data. All resent messages must have the resend bit set in the Status byte.

The scanner resends data two times after the initial send if the host fails to reply with an ACK or NAK (if ACK/NAK handshaking is enabled).

Baud Rate, Stop Bits, Parity, Response Timeout, ACK/NAK Handshaking

If you use PARAM_SEND to change these serial parameters, the ACK response to the PARAM_SEND uses the previous values for these parameters. The new values then take effect for the next transaction.

Errors

The scanner issues a communication error when:

- The CTS line is asserted when the scanner tries to transmit, and is still asserted on each of two successive retries
- The scanner does not receive an ACK or NAK after initial transmit and two resends.

SSI Communication Notes

- When not using hardware handshaking, space messages sufficiently apart. The host must not communicate with the scanner if the scanner is transmitting.
- When using hardware handshaking, frame each message properly with handshaking signals. Do not try to send two commands within the same handshaking frame.
- There is a permanent/temporary bit in the PARAM_SEND message. Removing power from the scanner discards temporary changes. Permanent changes are written to non-volatile memory. Frequent changes shorten the life of the non-volatile memory.

Using Time Delay to Low Power Mode with SSI

[Time Delay to Low Power Mode](#) provides options to select a general time delay. To program a more specific delay value, use an SSI command according to the following values.

Table 20 Values for Selecting Time Delay to Low Power

Value	Timeout	Value	Timeout	Value	Timeout	Value	Timeout
0x00	15 Min	0x10	1 Sec	0x20	1 Min	0x30	1 Hour
0x01	30 Min	0x11	1 Sec	0x21	1 Min	0x31	1 Hour
0x02	60 Min	0x12	2 Sec	0x22	2 Min	0x32	2 Hours
0x03	90 Min	0x13	3 Sec	0x23	3 Min	0x33	3 Hours
N/A	N/A	0x14	4 Sec	0x24	4 Min	0x34	4 Hours
N/A	N/A	0x15	5 Sec	0x25	5 Min	0x35	5 Hours
N/A	N/A	0x16	6 Sec	0x26	6 Min	0x36	6 Hours
N/A	N/A	0x17	7 Sec	0x27	7 Min	0x37	7 Hours
N/A	N/A	0x18	8 Sec	0x28	8 Min	0x38	8 Hours
N/A	N/A	0x19	9 Sec	0x29	9 Min	0x39	9 Hours
N/A	N/A	0x1A	10 Sec	0x2A	10 Min	0x3A	10 Hours
N/A	N/A	0x1B	15 Sec	0x2B	15 Min	0x3B	15 Hours
N/A	N/A	0x1C	20 Sec	0x2C	20 Min	0x3C	20 Hours
N/A	N/A	0x1D	30 Sec	0x2D	30 Min	0x3D	30 Hours
N/A	N/A	0x1E	45 Sec	0x2E	45 Min	0x3E	45 Hours
N/A	N/A	0x1F	60 Sec	0x2F	60 Min	0x3F	60 Hours



NOTE: With hardware handshaking disabled, the scanner wakes from low power mode upon receiving a character. However, the scanner does not process this character or any others it receives during the period following wakeup. Wait at least after wakeup to send valid characters.

Encapsulation of RSM Commands/Responses over SSI

The SSI protocol allows the host to send a command that is variable in length up to 255 bytes. Although there is a provision in the protocol to multi-packet commands from the host, the scanner does not support this. The host must fragment packets using the provisions in the RSM protocol.

Command Structure

Byte	7	6	5	4	3	2	1	0
0	Length (not including the checksum)							
1	SSI_MGMT_COMMAND (0x80)							
2	Message Source (4 - Host)							

Byte	7	6	5	4	3	2	1	0
3	Reserved (0)				Reserved (0)	Reserved (0)	Cont'd packet	Retransmit
4	Payload data (see the following example)							
...								
Length -1								
Length	2's complement checksum (MSB)							
Length +1	2's complement checksum (LSB)							

The expected positive response is SSI_MGMT_COMMAND which can be a multi-packet response. Devices that do not support this command respond with the standard SSI_NAK.

Response Structure

Byte	7	6	5	4	3	2	1	0
0	Length (not including the checksum)							
1	SSI_MGMT_COMMAND (0x80)							
2	Message Source (0 - Decoder)							
3	Reserved (0)				Reserved (0)	Reserved (0)	Cont'd packet	Retransmit
4	Payload data (see the following example)							
...								
Length -1								
Length	2's complement checksum (MSB)							
Length +1	2's complement checksum (LSB)							

Example Transaction

The following example illustrates how to retrieve diagnostic information (Diagnostic Testing and Reporting - Attribute #10061- decimal) from the scanner using encapsulation of RSM commands over SSI. Before sending an RSM command, the host must send the RSM Get Packet Size command to query the packet size supported by the device.

Command from Host to Query Packet Size Supported by Device

```
0A 80 04 00 00 06 20 00 FF FF FD 4E
```

Where:

- 0A 80 04 00 is encapsulation of RSM commands over SSI command header
- 00 06 20 00 FF FF is RSM Get Packet Size command
- FD 4E is SSI command checksum

Response from Device with Packet Size Information

```
0C 80 00 00 00 08 20 00 00 F0 00 F0 FD 6C
```

Where:

- 0C 80 00 00 is encapsulation of RSM command over SSI command header
- 00 08 20 00 00 F0 00 F0 is RSM Get Packet Size response
- FD 6C is SSI response checksum

Command from Host to Retrieve Diagnostic Information

```
0C 80 04 00 00 08 02 00 27 4D 42 00 FE B0
```

Where:

- 0C 80 04 00 is encapsulation of RSM commands over SSI command header
- 00 08 02 00 27 4D 42 00 is attribute Get command requesting attribute 10061 decimal
- FE B0 is SSI command checksum

Response from Device with Diagnostic Information

```
21 80 00 00 00 1D 02 00 27 4D 41 01 42 00 0E 00 00 00 00 01 03 02 03 03 04  
03 05 03 06 03 FF FF FC 15
```

Where:

- 21 80 00 00 00 1D 02 00 27 4D 41 01 42 00 0E 00 00 is encapsulation of RSM responses over SSI command header
- 00 00 01 03 02 03 03 03 04 03 05 03 06 03 is attribute Get response which includes diagnostic report value
- FF FF is attribute Get response, packet termination
- FC 15 is SSI response checksum

Setting SSI Parameters

You can set up a scanner with an SSI host. When using SSI, program the scanner via barcode menu or SSI hosts commands

The scanner ships with the settings shown in SSI Interface Defaults (also see for all defaults). If the default values suit requirements, programming is not necessary.

To set feature values, scan a single barcode or a short barcode sequence. The settings are stored in non-volatile memory and are preserved even when the scanner powers down.



NOTE: Most computer monitors allow scanning barcodes directly on the screen. When scanning from the screen, be sure to set the document magnification to a level where you can see the barcode clearly, and bars and/or spaces do not merge.

To return all features to default values, scan [Set Factory Defaults](#). Throughout the programming barcode menus, asterisks (*) indicate default values.

SSI Scanning Sequence Examples

In most cases scanning one barcode sets the parameter value. For example, to set the baud rate to 19,200, scan the **Baud Rate 19,200** barcode under [Baud Rate](#). The scanner issues a fast warble beep and the LED turns green, signifying a successful parameter entry.

Other parameters require scanning several barcodes. See the parameter descriptions for this procedure.

SSI Errors While Scanning

Unless otherwise specified, to correct an error during a scanning sequence, just re-scan the correct parameter.

Simple Serial Interface Parameter Defaults

The following table lists defaults for SSI host parameters.

You can change these values in one of two ways:

- Scan the appropriate barcodes in this section. The new value replaces the standard default value in memory. To recall default parameter values, see [Default Parameters](#).
- Download data through the device's serial port using SSI. Hexadecimal parameter numbers appear in this section below the parameter title, and option values display in parentheses beneath the accompanying barcodes. Refer to the Simple Serial Interface (SSI) Programmer's Guide for detailed instructions for changing parameters using this method.

Table 21 SSI Interface Default Table

Parameter	Parameter Number	SSI Number	Default
SSI Host Parameters			
Select SSI Host	N/A	N/A	N/A
Baud Rate	156	9Ch	9600
Parity	158	9Eh	None
Check Parity	151	97h	Disable
Stop Bits	157	9Dh	1
Software Handshaking	159	9Fh	ACK/NAK
Host RTS Line State	154	9Ah	Low
Decode Data Packet Format	238	EEh	Send Raw Decode Data
Host Serial Response Timeout	155	9Bh	2 Seconds
Host Character Timeout	239	EFh	200 msec
Multipacket Option	334	F0h 4Eh	Multipacket Option 1
Interpacket Delay	335	F0h 4Fh	0 msec
Event Reporting			
Decode Event	256	F0h 00h	Disable

Table 21 SSI Interface Default Table (Continued)

Parameter	Parameter Number	SSI Number	Default
Boot Up Event	258	F0h 02h	Disable
Parameter Event	259	F0h 03h	Disable



NOTE: SSI interprets Prefix, Suffix1, and Suffix2 values listed in [ASCII Character Sets](#) differently than other interfaces. SSI does not recognize key categories, only the 3-digit decimal value. The default value of 7013 is interpreted as CR only.

SSI Host Parameters

Scan barcodes to set SSI host parameters

Select SSI Host

Use this parameter to select SSI as the host interface.

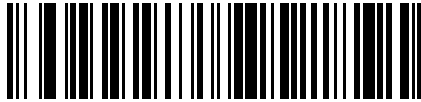

SSI Host

SSI Baud Rate

Parameter # 156 (SSI # 9Ch)

Baud rate is the number of bits of data transmitted per second.

Select an option to set the scanner's baud rate to match the baud rate setting of the host device. Otherwise, data may not reach the host device or may reach it in distorted form.

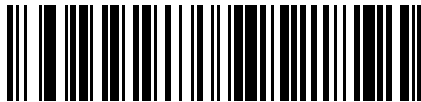

*Baud Rate 9600 (6)



Baud Rate 19,200 (7)



Baud Rate 38,400 (8)



Baud Rate 57,600 (10)

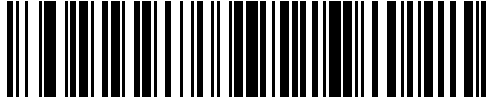

Baud Rate 115,200 (11)



Baud Rate 230,400 (13)

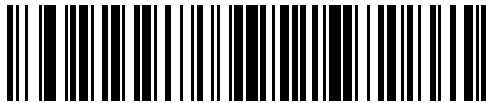

Baud Rate 460,800 (14)

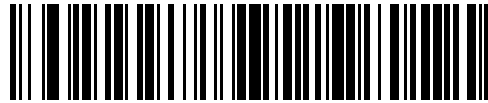

Baud Rate 921,600 (15)

SSI Parity

Parameter # 158 (SSI # 9Eh)

Choose whether code characters contain an odd or even number of 1 bits, or choose that no parity bit is required.

A parity check bit is the most significant bit of each ASCII coded character. Use this parameter to select the parity type according to host device requirements.

- Odd - This sets the parity bit value to 0 or 1, based on data, to ensure that the coded character contains an odd number of 1 bits.
- Even - This sets the parity bit value to 0 or 1, based on data, to ensure that the coded character contains an even number of 1 bits.
- None - No parity bit is required.

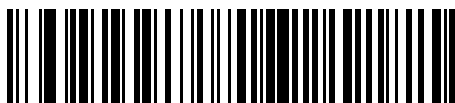

Odd (2)

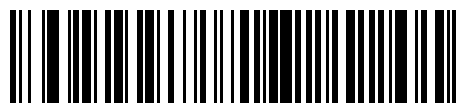

Even (1)



*None (0)

Check Parity

Parameter # 151 (SSI # 97h)

Choose whether to check the parity of received characters.

Use this parameter to select whether to check the parity of received characters. See [SSI Parity](#) to select the type of parity.

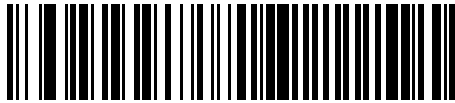

*Do Not Check Parity (0)



Check Parity (1)

SSI Stop Bits

Parameter # 157 (SSI # 9Dh)

The stop bit(s) at the end of each transmitted character marks the end of transmission of one character and prepares the receiving device for the next character in the serial data stream.

Select an option to set the number of stop bits (one or two) based on the number the receiving host can accommodate.



*1 Stop Bit (1)



2 Stop Bits (2)

Software Handshaking

Parameter # 159 (SSI # 9Fh)

This parameter offers control of data transmission in addition to the control hardware handshaking offers. Hardware handshaking is always enabled; you cannot disable it.

- Disable ACK/NAK Handshaking - The scanner neither generates nor expects ACK/NAK handshaking packets.
- Enable ACK/NAK Handshaking - After transmitting data, the scanner expects either an ACK or NAK response from the host. The scanner also ACKs or NAKs messages from the host. The scanner waits up to the programmable [Host Serial Response Timeout](#) to receive an ACK or NAK. If the scanner does not get a response in this time, it resends its data up to two times before discarding the data and declaring a transmission error.

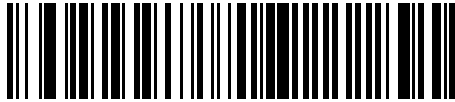

Disable ACK/NAK (0)

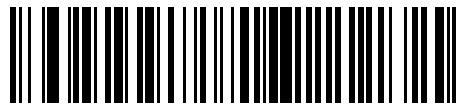

*Enable ACK/NAK (1)

Host RTS Line State

Parameter # 154 (SSI # 9Ah)

This parameter sets the expected idle state of the Serial Host RTS line.

The SSI interface is used with host applications that also implement the SSI protocol. However, you can use the scanner in a "scan-and-transmit" mode to communicate with any standard serial communication software on a host PC (see [Decode Data Packet Format](#)). If transmission errors occur in this mode, the host PC may be asserting hardware handshaking lines that interfere with the SSI protocol. Scan the High barcode to address this problem.

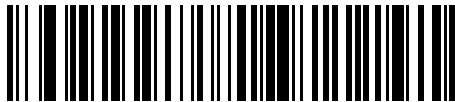

*Low (0)



High (1)

Decode Data Packet Format

Parameter # 238 (SSI # EEh)

Use this parameter to select whether to transmit decoded data in raw format (unpacked), or with the packet format defined by the serial protocol.



NOTE: Selecting the raw format disables ACK/NAK handshaking for decode data.

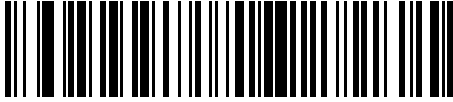

*Send Raw Decode Data (0)



Send Packeted Decode Data (1)

Host Serial Response Timeout (SSI)

Parameter # 155 (SSI # 9Bh)

This parameter specifies how long a scanner waits for an ACK or NAK before resending.

If the scanner wants to send, and the host has already been granted permission to send, the scanner waits for the designated timeout before declaring an error.



NOTE: Other values are available via SSI command.

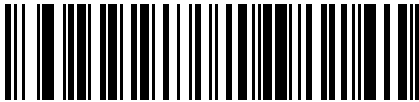

*Low - 2 Seconds (20)

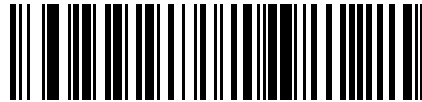

Medium - 5 Seconds (50)

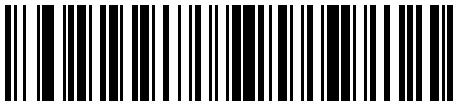

High - 7.5 Seconds (75)



Maximum - 9.9 Seconds (99)

Host Character Timeout

Parameter # 239 (SSI # EFh)

This parameter specifies the maximum time a scanner waits between characters transmitted by the host before discarding the received data and declaring an error.

Select an option to specify the maximum time the scanner waits from Low to High.



NOTE: Other values are available via SSI command.



*Low - 200 msec (20)



Medium - 500 msec (50)



High - 750 msec (75)

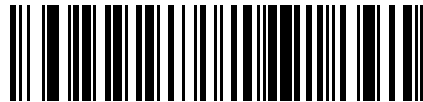

Maximum - 990 msec (99)

Multipacket Option

Parameter # 334 (SSI # F0h 4Eh)

This parameter controls ACK/NAK handshaking for multi-packet transmissions.

- Multi-Packet Option 1 - The host sends an ACK/NAK for each data packet during a multi-packet transmission.
- Multi-Packet Option 2 - The scanner sends data packets continuously, with no ACK/NAK handshaking to pace the transmission. The host, if overrun, can use hardware handshaking to temporarily delay scanner transmissions. At the end of transmission, the scanner waits for a CMD_ACK or CMD_NAK.
- Multi-Packet Option 3 - This is the same as option 2 with the addition of a programmable interpacket delay. See [Interpacket Delay](#) to set this delay.

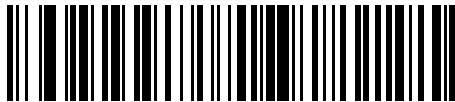

*Multipacket Option 1 (0)

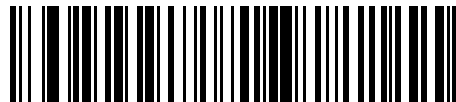

Multipacket Option 2 (1)



Multipacket Option 3 (2)

Interpacket Delay

Parameter # 335 (SSI # F0h 4Fh)

This parameter specifies the interpacket delay if you selected Multipacket Option 3.



NOTE: Other values are available via SSI command.



*Minimum - 0 msec (0)

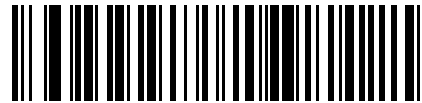

Low - 25 msec (25)



Medium - 50 msec (50)

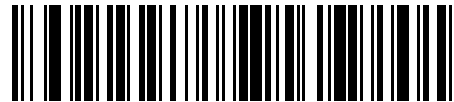

High - 75 msec (75)



Maximum - 99 msec (99)

Event Reporting

The host can request the scanner to provide certain information (events) relative to scanner behavior.

Scan the following barcodes to enable or disable events.

Table 22 Event Codes

Event Class	Event	Code Reported
Decode Event	Non-parameter decode	0x01
Boot Up Event	System power-up	0x03
Parameter Event	Parameter entry error	0x07
	Parameter stored	0x08
	Defaults set (and parameter event is enabled by default)	0x0A
	Number expected	0x0F

Decode Event

Parameter # 256 (SSI # F0h 00h)

Use this parameter to enable or disable a non-parameter decode event.

- Enable Decode Event - scanner generates a message to the host upon a successful barcode decode.
- Disable Decode Event - no notification is sent.

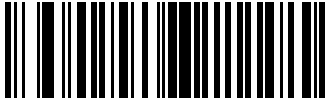

Enable Decode Event (1)

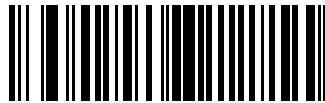

*Disable Decode Event (0)

Boot Up Event

Parameter # 258 (SSI # F0h 02h)

Use this parameter to enable or disable a system power-up event.

- Enable Boot Up Event - scanner generates a message to the host whenever power is applied.
- Disable Boot Up Event - no notification is sent.

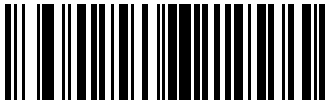

Enable Boot Up Event (1)



*Disable Boot Up Event (0)

Parameter Event

Parameter # 259 (SSI # F0h 03h)

Use this parameter to enable or disable parameter events.

- Enable Parameter Event - scanner generates a message to the host when one of the events specified in [Event Reporting](#) occurs.
- Disable Parameter Event - no notification is sent.



Enable Parameter Event (1)



*Disable Parameter Event (0)

RS-232 Interface

You can set up a scanner with an RS-232 host. The scanner uses the RS-232 interface to connect to point-of-sale devices, host computers, or other devices with an available RS-232 port (e.g., com port).

The scanner ships with the settings shown in [RS-232 Parameter Defaults](#) on page 188. If the default values suit requirements, programming is not necessary.

If your host does not appear in , refer to the documentation for the host device to set communication parameters to match the host.



NOTE: The scanner uses TTL RS-232 signal levels, which interface with most system architectures. For system architectures requiring RS-232C signal levels, Zebra offers different cables providing TTL-to-RS-232C conversion. Contact support for more information.

Connecting an RS-232 Interface

Connect the scanner directly to the host computer.

Figure 9 RS-232 Connection

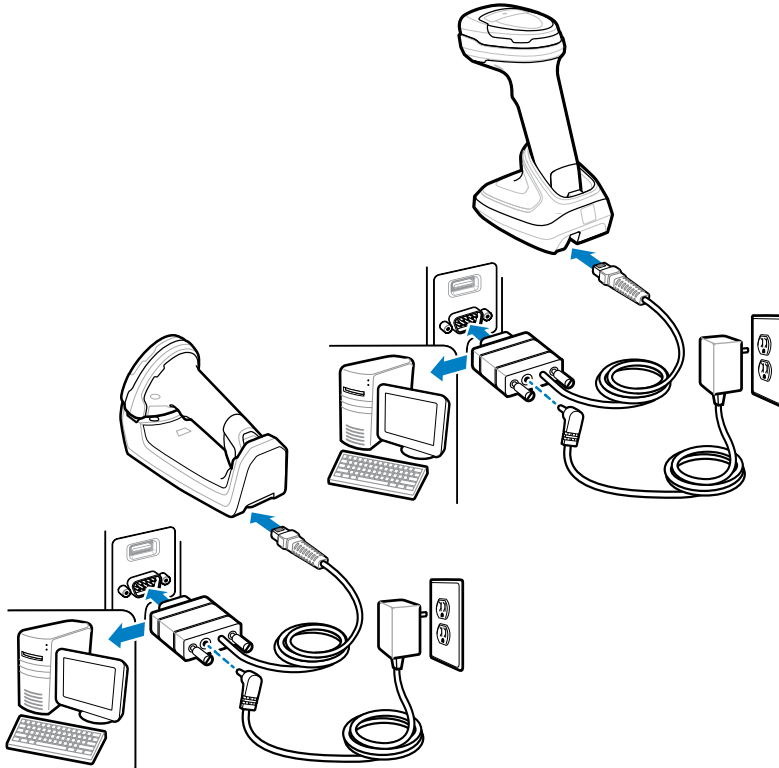

NOTE: Interface cables vary depending on configuration. The connectors can be different than those illustrated, but the steps to connect the scanner are the same.

1. Attach the modular connector of the RS-232 interface cable to the cable interface port on the scanner.
2. Connect the other end of the RS-232 interface cable to the serial port on the host.
3. If required, connect the power supply to the serial connector end of the RS-232 interface cable. Plug the power supply into an appropriate outlet.
4. The scanner automatically detects the host interface type and uses the default setting. If the default (*) does not meet your requirements, select another RS-232 host type by scanning the appropriate barcode from [RS-232 Host Types](#).
5. To modify any other parameter options, scan the appropriate barcodes in this section.

If problems occur with the system, see [Troubleshooting](#).

RS-232 Parameter Defaults

The following table lists defaults for RS-232 host parameters. You can change the default values in one of two ways:

- Scan the appropriate barcodes in this section. The new value replaces the standard default value in memory. To recall default parameter values, see [Default Parameters](#).
- Configure the scanner using the 123Scan configuration program. See [123Scan and Software Tools](#).

Table 23 RS-232 Interface Parameter Defaults

Parameter	Default
RS-232 Host Parameters	
RS-232 Host Types	Standard
Baud Rate	9600
Parity	None
Stop Bits	1 Stop Bit
Data Bits	8-bit
Check Receive Errors	Enable
Hardware Handshaking	None
Software Handshaking	None
Host Serial Response Timeout	2 Seconds
RTS Line State	Low RTS
Beep on <BEL>	Disable
Intercharacter Delay	0 msec
Nixdorf Beep/LED Options	Normal Operation
Barcodes with Unknown Characters	Send Barcode With Unknown Characters
Datalogic Host Format	Enable
Datalogic Supported Commands	Disable

RS-232 Host-Specific Parameter Settings

Some RS-232 hosts use their own parameter default settings.

Various RS-232 hosts use their own parameter default settings. Selecting Standard, ICL, Jujitsu, Wincor-Nixdorf Mode A, Wincor-Nixdorf Mode B, OPOS/JPOS, Olivetti, Omron, or Common Use Terminal Equipment (CUTE-LP/LG barcode readers) sets the defaults listed in the table below.

Table 24 Terminal Specific RS-232

Parameter	ICL	Fujitsu	Wincor-Nixdorf Mode A	Wincor-Nixdorf Mode B ^a /OPOS/JPOS	Olivetti	Omron	CUTE	Datalogic
Transmit Code ID	Yes	Yes	Yes	Yes	Yes	Yes	Yes	Yes
Data Transmission Format	Data/Suffix	Data/Suffix	Data/Suffix	Data/Suffix	Prefix/Data/Suffix	Data/Suffix	Prefix/Data/Suffix	Data/Suffix
Suffix	CR (1013)	CR (1013)	CR (1013)	CR (1013)	ETX (1002)	CR (1013)	CR (1013) ETX (1003)	CR (1013)
Baud Rate	9600	9600	9600	9600	9600	9600	9600	9600
Parity	Even	None	Odd	Odd	Even	None	Even	Odd
Hardware Handshaking	TRS/CTS Option 3	None	TRS/CTS Option 3	TRS/CTS Option 3	None	None	None	None
Software Handshaking	None	None	None	None	ACK.NAK	None	None	None
Serial Response Timeout	9.9 sec.	2 sec.	None	None	9.9 sec.	9.9 sec.	9.9 sec.	9.9 sec.
Stop Bit Select	One	One	One	One	One	One	One	One
ASCII Format	8-Bit	8-Bit	8-Bit	8-Bit	7-Bit	8-Bit	7-Bit	7-Bit
Beep on <BEL>	Disable	Disable	Disable	Disable	Disable	Disable	Disable	Enable
RTS Line State	High	Low	Low	Low = no data to send	Low	High	High	High
Prefix	None	None	None	None	STX (1003)	None	STX (1002)	None
UPC-A	A	A	A	A	A	A	A	A
UPC-E	E	E	C	C	C	C	None	E
EAN-8/JAN-8	FF	FF	B	B	B	FF	None	FF
EAN-13/JAN-13	F	F	A	A	A	F	A	F
Code 39	C <len>	None	M	M	M <len>	C <len>	3	b
Code 39 Full ASCII	None	None	M	M	None	None	3	None

Table 24 Terminal Specific RS-232 (Continued)

Parameter	ICL	Fujitsu	Wincor-Nixdorf Mode A	Wincor-Nixdorf Mode B ^a /OPOS/JPOS	Olivetti	Omron	CUTE	Datalogic
Codabar	N <len>	None	N	N	N <len>	N <len>	None	%
Code 128	L <len>	None	K	K	K <len>	L <len>	5	#
I 2 of 5	I <len>	None	I	I	I <len>	I <len>	1	i
Code 93	None	None	L	L	L <len>	Noe	None	&
D 2 of 5	H <len>	None	H	H	H <len>	H <len>	2	None
GS1-128	L <len>	None	P	P	P <len>	L <len>	5	None
MSI	None	None	O	O	O <len>	None	None	@
Bookland EAN	F	F	A	A	A	F	None	None
Trioptic	None	None	None	None	None	None	None	\$T
Code 11	None	None	None	None	None	None	None	CE
IATA	H<len>	None	H	H	H<len>	H<len>	2	IA
Code 32	None	None	None	None	None	None	None	AE
GS1 DataBar Variants	None	None	E	E	None	None	None	GS1 DataBar - R4; GS1 DataBar Limited - RL; GS1 DataBar Expanded - RX
PDF417	None	None	Q	Q	None	None	6	P
Data Matrix	None	None	R	R	None	None	4	Dm
QR Codes	None	None	U	U	None	None	7	QR
Aztec/Aztec Rune	None	None	V	V	None	None	8	Az
MAXICODE	None	None	T	T	None	None	None	MC
microPDF	None	None	S	S	None	None	6	mP
Australia Post	None	None	None	None	None	None	None	\$K

Table 24 Terminal Specific RS-232 (Continued)

Parameter	ICL	Fujitsu	Wincor-Nixdorf Mode A	Wincor-Nixdorf Mode B ^a / OPOS/ JPOS	Olivetti	Omron	CUTE	Datalogic
Japan Postal	None	None	None	None	None	None	None	\$R
US Planet	None	None	None	None	None	None	None	\$W
US Postnet	None	None	None	None	None	None	None	1

^a In the Nixdorf Mode B, if CTS is low, scanning is disabled. When CTS is high, scanning is enabled. If you scan Nixdorf Mode B without connecting the digital scanner to the proper host, it may appear unable to scan. If this happens, scan a different RS-232 host type within 5 sec. of cycling power to the digital scanner. The CUTE host disables all parameter scanning, including Set Defaults. If you inadvertently select CUTE, scan [Enable Parameter Barcode Scanning \(1\)](#), then change the host selection.

^b In NCR-LEGACY mode, the Code-ID transmits a P.

RS-232 Host Types

Select an RS-232 host interface using one of the following options.

Notes on using RS-232 host types:

- For a list of supported scanner functionality by communication protocol, see [Communication Protocol Functionality](#).
- Scanning Standard RS-232 activates the RS-232 driver, but does not change port settings (for example, parity, data bits, handshaking). Selecting another RS-232 host type barcode changes these settings.
- The CUTE host disables all parameter scanning, including Set Defaults. If you inadvertently select CUTE, scan [Enable Parameter Barcode Scanning](#), and then change the host selection.



*Standard RS-232

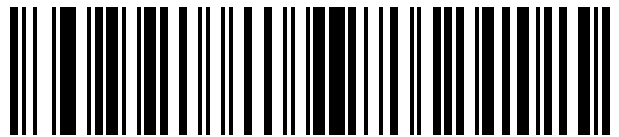

ICL RS-232

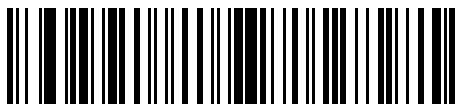

Nixdorf RS-232 Mode A



Olivetti ORS4500



Nixdorf RS-232 Mode B



Omron



OPOS/JPOS

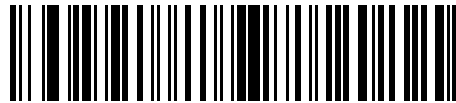

Fujitsu RS-232



CUTE



Datalogic Variant

RS-232 Baud Rate

The RS-232 baud rate is the number of bits of data transmitted per second.

Select an option to set the scanner's baud rate to match the baud rate setting of the host device. Otherwise, data may not reach the host device or may reach it in distorted form.



Baud Rate 4800

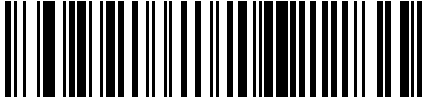

*Baud Rate 9600



Baud Rate 19,200

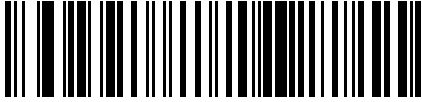

Baud Rate 38,400

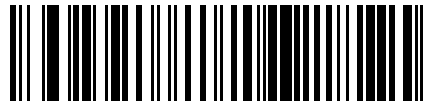

Baud Rate 57,600

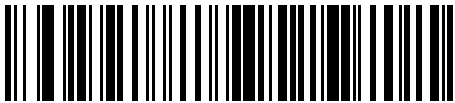

Baud Rate 115,200

RS-232 Parity

A parity check bit is the most significant bit of each ASCII coded character. Choose an option to select the parity type according to host device requirements.

- Odd - This sets the parity bit value to 0 or 1, based on data, to ensure that the coded character contains an odd number of 1 bits.
- Even - This sets the parity bit value to 0 or 1, based on data, to ensure that the coded character contains an even number of 1 bits.
- None - No parity bit is required.

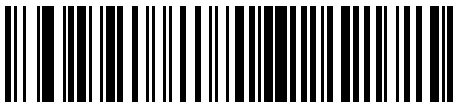

Odd



Even

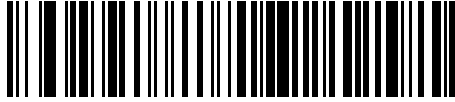

*None

RS-232 Stop Bits

The stop bit(s) at the end of each transmitted character marks the end of transmission of one character and prepares the receiving device for the next character in the serial data stream. Select an option to set the number of stop bits (one or two) based on the number the receiving host can accommodate.

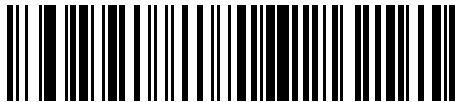

*1 Stop Bit



2 Stop Bits

Data Bits

This parameter allows the scanner to interface with devices requiring a 7-bit or 8-bit ASCII protocol.

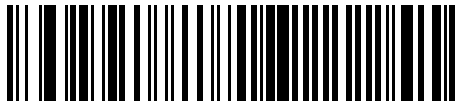

7-bit

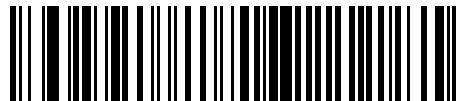

*8-bit

Check Receive Errors

This parameter determines whether to check the parity, framing, and overrun of received characters.



NOTE: The parity value of received characters is verified against the value set for [Parity](#).

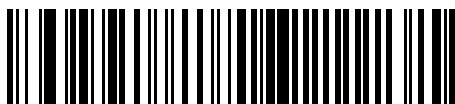

*Check For Received Errors



Do Not Check For Received Errors

Hardware Handshaking

The data interface consists of an RS-232 port designed to operate either with or without the hardware handshaking lines Request to Send (RTS) and Clear to Send (CTS).

If hardware handshaking and software handshaking are both enabled, hardware handshaking takes precedence.



NOTE: The DTR signal is jumpered to the active state.

You can choose one of the following options:

None

This disables hardware handshaking and transmits scan data as it becomes available.

Standard RTS/CTS

This sets standard RTS/CTS hardware handshaking and transmits scanned data. The scanner reads the CTS line for activity according to the following sequence:

- If the CTS line is de-asserted, the scanner asserts the RTS line and waits up to [Host Serial Response Timeout](#) for the host to assert CTS, and then transmits data when asserted. If, after the timeout, the CTS line is not asserted, the scanner sounds a transmit error and discards the data.
- If CTS is asserted, the scanner waits up to [Host Serial Response Timeout](#) for the host to de-assert CTS. If after this timeout the CTS line is still asserted, the scanner sounds a transmit error and discards the scanned data.
- The scanner de-asserts RTS after sending the last character of data.
- The host negates CTS. The scanner checks for a de-asserted CTS upon the next data transmission.



NOTE: During data transmission, if CTS is deasserted for more than 50 ms between characters, the scanner sounds a transmit error and discards the data. The data must be re-scanned.

RTS/CTS Option 1

The scanner asserts RTS before transmitting and ignores the state of CTS. The scanner de-asserts RTS when transmission completes.

RTS/CTS Option 2

RTS is always high or low (user-programmed logic level). However, the scanner waits for the host to assert CTS before transmitting data. If CTS is not asserted within the [Host Serial Response Timeout](#), the scanner sounds a transmit error and discards the data. During data transmission, if CTS is deasserted for more than 50 ms between characters, the scanner sounds a transmit error and discards the data.

RTS/CTS Option 3

This transmits scanned data according to the following sequence:

- The scanner asserts RTS before data transmission, regardless of the state of CTS.
- The scanner waits up to the [Host Serial Response Timeout](#) for the host to assert CTS, and then transmits data when asserted. If, after the timeout, the CTS line is not asserted, the scanner sounds a transmit error and discards the data.
- The scanner de-asserts RTS after sending the last character of data.
- The host negates CTS. The scanner checks for a de-asserted CTS upon the next data transmission.



NOTE: During data transmission, if CTS is deasserted for more than 50 ms between characters, the scanner sounds a transmit error and discards the data. The data must be re-scanned.

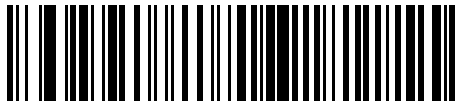

*None

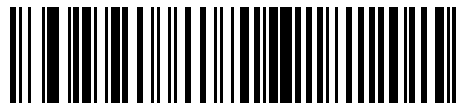

Standard RTS/CTS

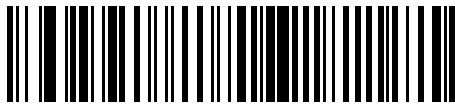

RTS/CTS Option 1

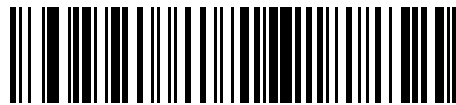

RTS/CTS Option 2

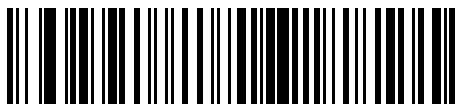

RTS/CTS Option 3

Software Handshaking

This parameter offers control of data transmission in addition to, or instead of, that offered by hardware handshaking. If software handshaking and hardware handshaking are both enabled, hardware handshaking takes precedence.

- None - This transmits data immediately. The scanner expects no response from the host.
- ACK/NAK - After transmitting data, the scanner waits for an ACK or NAK response from the host. If it receives a NAK, the scanner transmits the data again and waits for an ACK or NAK. After three unsuccessful attempts to send data after receiving NAKs, the scanner sounds a transmit error and

discards the data. The scanner waits up to the programmable [Host Serial Response Timeout](#) to receive an ACK or NAK. If the scanner does not get a response in this time, it sounds a transmit error and discards the data. There are no reattempts.

- ENQ - The scanner waits for an ENQ character from the host before transmitting data. If it does not receive an ENQ within the [Host Serial Response Timeout](#), the scanner sounds a transmit error and discards the data. The host must transmit an ENQ character at least every [Host Serial Response Timeout](#) to prevent transmission errors.
- ACK/NAK with ENQ - This combines the two previous options. An additional ENQ is not required to re-transmit data due to a NAK from the host.
- XON/XOFF - An XOFF character stops data transmission until the scanner receives an XON character. There are two situations for XON/XOFF:
 - The scanner receives an XOFF before it has data to send. When the scanner has data, it waits up to the [Host Serial Response Timeout](#) for an XON character before transmitting. If it does not receive the XON within this time, the scanner sounds a transmit error and discards the data.
 - The scanner receives an XOFF during data transmission and stops transmission after sending the current byte. When the scanner receives an XON character, it sends the rest of the data. The scanner waits indefinitely for the XON.

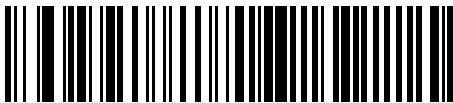

*None

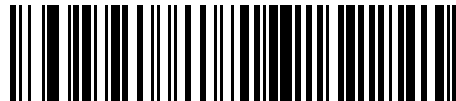

ACK/NAK

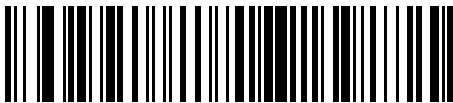

ENQ



ACK/NAK with ENQ

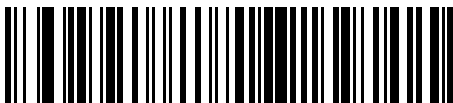

XON/XOFF

RS-232 Host Serial Response Timeout

This parameter specifies how long the scanner waits for an ACK, NAK, or CTS before determining that a transmission error occurred. This only applies when in one of the ACK/NAK software handshaking modes, or RTS/CTS hardware handshaking mode.



*Minimum: 2 Seconds



Low: 2.5 Seconds



Medium: 5 Seconds

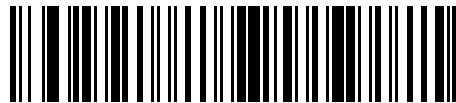

High: 7.5 Seconds

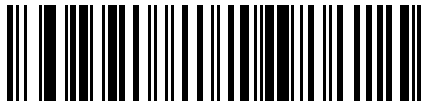

Maximum: 9.9 Seconds

RTS Line State

This parameter sets the idle state of the serial host RTS line to Low RTS or High RTS.

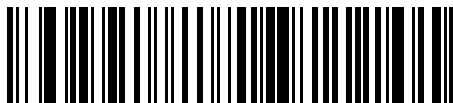

*Host: Low RTS

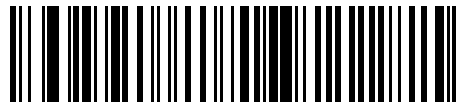

Host: High RTS

Beep on <BEL>

This parameter sets whether the scanner issues a beep when it detects a <BEL> character on the RS-232 serial line. <BEL> indicates an illegal entry or another important event.

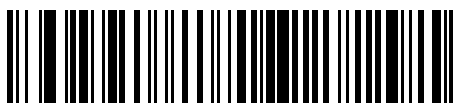

Beep On <BEL> Character (Enable)



*Do Not Beep On <BEL> Character (Disable)

Intercharacter Delay

This parameter specifies the intercharacter delay inserted between character transmissions.

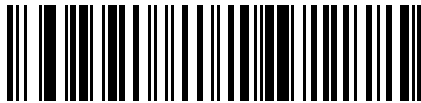

*Minimum: 0 msec

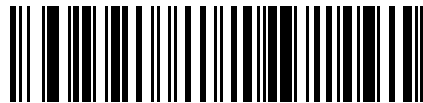

Low: 25 msec



Medium: 50 msec



High: 75 msec



Maximum: 99 msec

Nixdorf Beep/LED Options

If you selected Nixdorf Mode B, scan one of the following barcodes to indicate when the scanner beeps and turns on its LED after a decode.

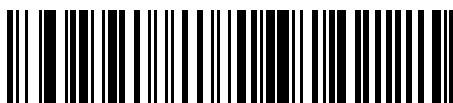

*Normal Operation (Beep/LED Immediately After Decode)



Beep/LED After Transmission



Beep/LED After CTS Pulse

RS-232 Barcodes with Unknown Characters

Unknown characters are characters the host does not recognize. Select Send Barcodes With Unknown Characters to send all barcode data except for unknown characters. The scanner issues no error beeps.

Select Do Not Send Barcodes With Unknown Characters to send barcode data up to the first unknown character. The scanner issues an error beep.

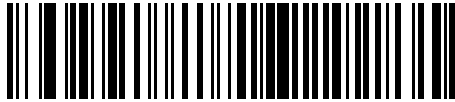

*Send Barcodes With Unknown Characters

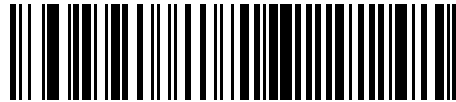

Do Not Send Barcodes With Unknown Characters

Datalogic Host Format

Parameter # 2253 (SSI # F8 08 CD)

When this parameter is enabled (default), the Datalogic host variant appends a code ID and a suffix value (CR) to the decoded data. When this parameter is disabled, only the decode data is transmitted. These commands are supported over RS232 or USB CDC.



*Enable (1)

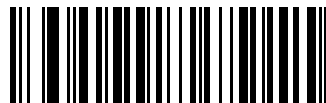

Disable (0)

Datalogic Supported Commands

Parameter # 2260 (SSI # F8 08 D4)

This parameter allows serial scan to enable or disable commands for a standard RS232 host.

- 'E' or 'e' = Enable Scanning
- 'D' or 'd' = Disable Scanning
- 'R' = Reset the scanner
- 'F' = Indicate to the scanner that Datalogic is not on file
- 'B' = Issue a good read beep
- 1 (Not an ASCII Character – This is a decimal number 1) = Force a good read beep
- 7 (Not an ASCII Character – This is a decimal number 7) = Force a good read beep

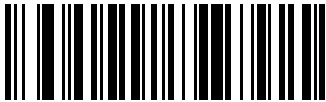

Enable (1)

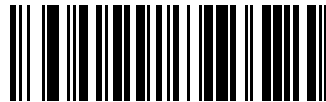

*Disable (0)

RS-232 ASCII Character Sets

You can refer to the ASCII Character Sets for prefix and suffix values.

See [ASCII Character Sets](#) for prefix/suffix values.

IBM 468X / 469X Interface

This section describes how to set up the scanner with an IBM 468X/469X host.

The scanner ships with the settings shown in [IBM 468X/469X Interface Parameter Defaults](#). If the default values suit requirements, programming is not necessary.

Connecting an IBM 468X/469X Host

Connect the scanner directly to the host computer.

Figure 10 IBM Connection

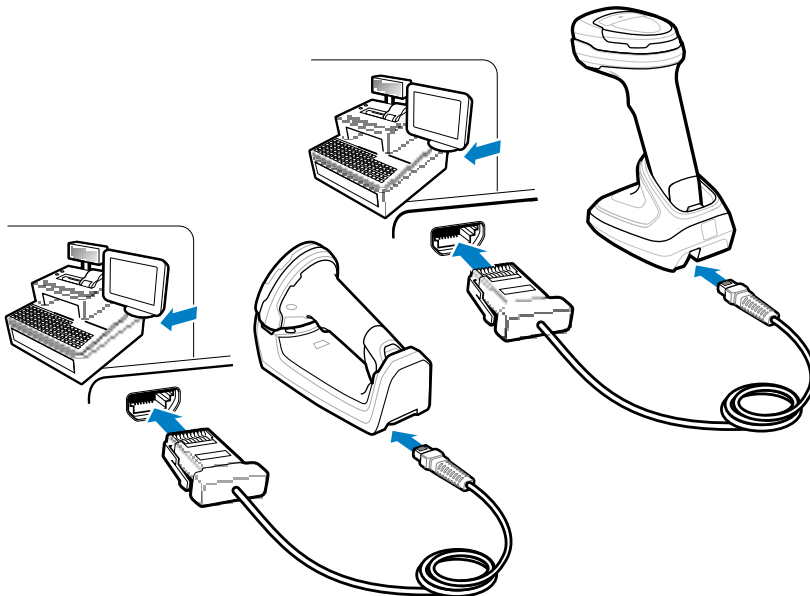

NOTE: Interface cables vary depending on configuration. The connectors can be different than those illustrated, but the steps to connect the scanner are the same.

1. Attach the modular connector of the IBM 46XX interface cable to the cable interface port on the scanner.
2. Connect the other end of the IBM 46XX interface cable to the appropriate port on the host (typically Port 9).

3. The scanner automatically detects the host interface type, but there is no default setting. Scan the appropriate barcode from [Port Address](#) to select the port address.
4. To modify any other parameter options, scan the appropriate barcodes in this section.



NOTE: The only required configuration is the port address. The IBM system typically controls other scanner parameters.

If problems occur with the system, see [Troubleshooting](#) .

IBM Parameter Defaults

The following table lists defaults for the IBM 468X/469X interface parameters. You can change default values in one of two ways:

- Scan the appropriate barcodes in this section. The new value replaces the standard default value in memory. To recall default parameter values, see [Default Parameters](#).
- Configure the scanner using the 123Scan configuration program. See [123Scan and Software Tools](#).

Table 25 IBM 468X/469X Interface Parameter Defaults

Parameter	Default
IBM 468X/469X Host Parameters	
Port Address	None
Convert Unknown to Code 39	Disable
RS-485 Beep Directive	Honor
RS-485 Barcode Configuration Directive	Ignore
IBM-485 Specification Version	Original Specification

IBM Host Parameters

Port Address

This parameter selects the IBM 468X/469X port.



NOTE: Selecting a Port Address barcode enables the RS-485 interface on the device.



*None

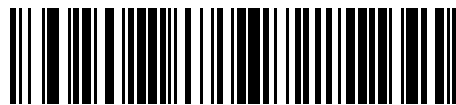

Hand-held Scanner Emulation (Port 9B)



Non-IBM Scanner Emulation (Port 5B)

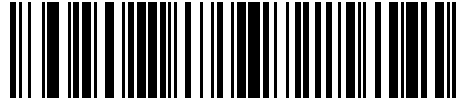
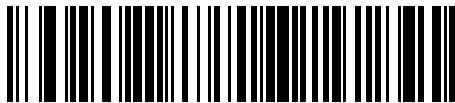

Table-top Scanner Emulation (Port 17)

Convert Unknown to Code 39

This parameter enables or disables converting unknown barcode type data to Code 39.



Enable Convert Unknown to Code 39

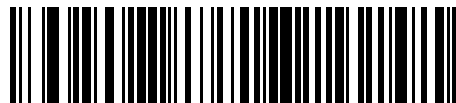

*Disable Convert Unknown to Code 39

RS-485 Beep Directive

The IBM RS-485 host can send a beeper configuration request to the scanner. Select Ignore Beep Directive to prevent the scanner from processing the host request. All directives are still acknowledged to the host as if they were processed.

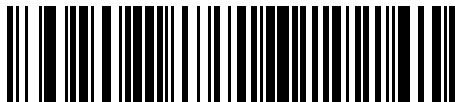

*Honor Beep Directive

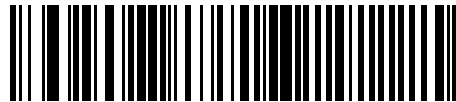

Ignore Beep Directive

RS-485 Barcode Configuration Directive

The IBM RS-485 host can enable and disable code types. Select Ignore Barcode Configuration Directive to prevent the scanner from processing the host request. All directives are still acknowledged to the IBM RS-485 host as if they were processed.

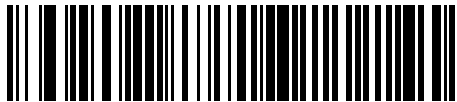

Honor Barcode Configuration Directive



*Ignore Barcode Configuration Directive

IBM-485 Specification Version

Parameter # 1729 (SSI # F8h 06h C1h)

This parameter determines which symbologies are reported.

- IBM-485 Original Specification - reports only symbologies historically supported on each port as known.
- IBM-485 - reports all symbologies supported in the new IBM specification as known with the respective code types.



*IBM-485 Original Specification (0)



IBM-485 (1)

Keyboard Wedge Interface

This section describes how to set up the scanner with a keyboard wedge interface.

The scanner connects between the keyboard and host computer and translates barcode data into keystrokes, which the host accepts as if they originated from the keyboard. This mode adds barcode reading functionality to a system designed for manual keyboard input. Keyboard keystrokes are simply passed through.

The scanner ships with the settings shown in [Keyboard Wedge Interface Parameter Defaults](#). If the default values suit requirements, programming is not necessary.

Connecting a Keyboard Wedge Interface

Connect the scanner between the keyboard and host computer.

Figure 11 Keyboard Wedge Connection

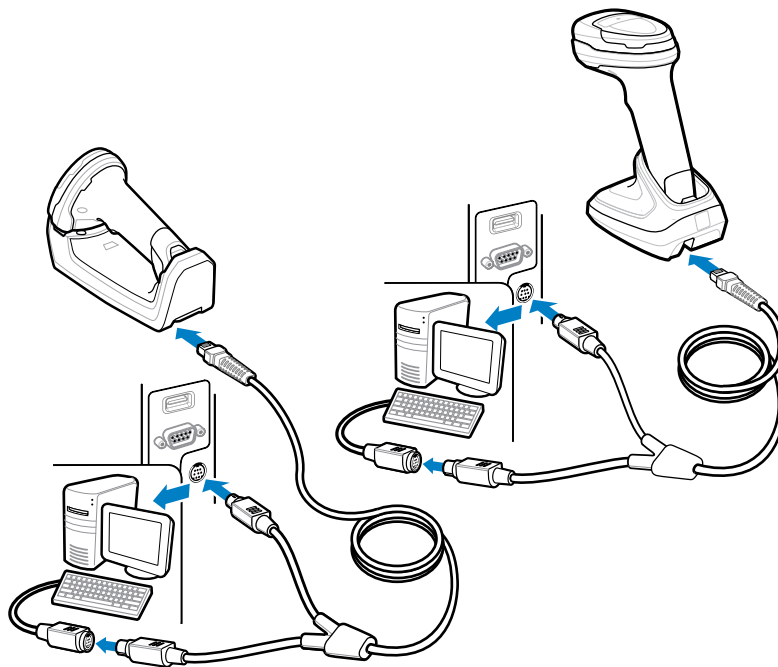

NOTE: Interface cables vary depending on configuration. The connectors can be different than those illustrated, but the steps to connect the scanner are the same.

1. Turn off the host and unplug the keyboard connector.
2. Attach the modular connector of the Y-cable to the cable interface port on the scanner. See [Installing Interface Cable](#).
3. Connect the round male DIN host connector of the Y-cable to the keyboard port on the host device.
4. Connect the round female DIN keyboard connector of the Y-cable to the keyboard connector.
5. If required, attach the optional power supply to the connector in the middle of the Y-cable.
6. Ensure that all connections are secure.
7. Turn on the host system.
8. The scanner automatically detects the host interface type and uses the default setting. If the default (*) does not meet your requirements, scan [Keyboard Wedge Host Parameters](#).
9. To modify other parameter options, scan the appropriate barcodes in this guide.

If problems occur with the system, see [Troubleshooting](#).

Keyboard Wedge Parameter Defaults

The following table lists defaults for keyboard wedge host parameters.

Change these values in one of two ways:

- Scan the appropriate barcodes in this section. The new value replaces the standard default value in memory. To recall default parameter values, see [Default Parameters](#).
- Configure the scanner using the 123Scan configuration program. See [123Scan and Software Tools](#).

Table 26 Keyboard Wedge Interface Parameter Defaults

Parameter	Default
Keyboard Wedge Host Parameters	
Keyboard Wedge Host Type	IBM AT Notebook
Barcodes with Unknown Characters	Send Barcodes with Unknown Characters
Keystroke Delay	No Delay
Intra-keystroke Delay	Disable
Alternate Numeric Keypad Emulation	Enable
Quick Keypad Emulation	Enable
Simulated Caps Lock	Disable
Caps Lock Override	Disable
Convert Case	Do Not Convert
Function Key Mapping	Disable
FN1 Substitution	Disable
Send Make and Break	Send

Keyboard Wedge Host Parameters

The parameters in this section control Keyboard Wedge Host characteristics.

Keyboard Wedge Host Types

Use this parameter to select the keyboard wedge host.



NOTE: For a list of supported scanner functionality by communication protocol, see [Communication Protocol Functionality](#).

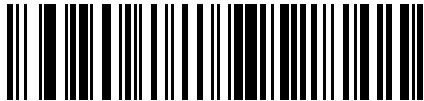

IBM PC/AT & IBM PC Compatibles



*IBM AT Notebook

Barcodes with Unknown Characters

Unknown characters are characters the host does not recognize. This parameter determines how to process barcodes containing unknown characters.

- Send Barcodes With Unknown Characters - sends all barcode data except for unknown characters. The scanner issues no error beeps.
- Do Not Send Barcodes With Unknown Characters - sends barcode data up to the first unknown character. The scanner issues an error beep.

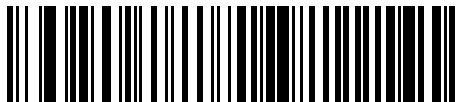

*Send Barcodes with Unknown Characters



Do Not Send Barcodes with Unknown Characters

Keystroke Delay

This is the delay in milliseconds between emulated keystrokes. Select an option to increase the delay when hosts require slower data transmission.

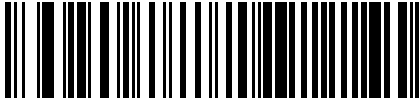

*No Delay



Medium Delay (20 msec)

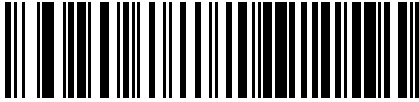

Long Delay (40 msec)

Intra-keystroke Delay

Select Enable Intra-keystroke Delay to insert an additional delay between each emulated key press and release. This also sets [Keystroke Delay](#) to a minimum of 5 msec.

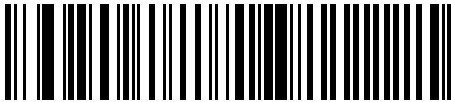

Enable Intra-keystroke Delay

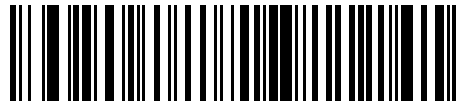

*Disable Intra-keystroke Delay

Alternate Numeric Keypad Emulation

This allows emulation of most other country keyboard types not listed in [Country Codes](#) in a Microsoft® operating system environment.



NOTE: If your keyboard type is not listed in the country code list (see [Country Codes](#)), disable [Quick Keypad Emulation](#) and ensure Alternate Numeric Keypad Emulation is enabled.

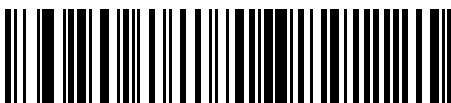

*Enable Alternate Numeric Keypad

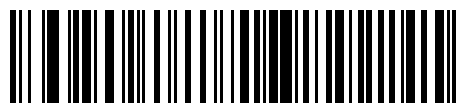

Disable Alternate Numeric Keypad

Quick Keypad Emulation (Keyboard Wedge)

This enables faster keypad emulation where character value sequences are only sent for characters not found on the keyboard.



NOTE: This option applies only when [Alternate Numeric Keypad Emulation](#) is enabled.

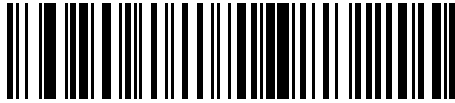

*Enable Quick Keypad Emulation



Disable Quick Keypad Emulation

Simulated Caps Lock (Keyboard Wedge)

Select Enable Caps Lock to invert upper and lower case characters on the barcode as if the Caps Lock state is enabled on the keyboard. This inversion occurs regardless of the keyboard's Caps Lock state.



NOTE: This only applies to alpha characters.

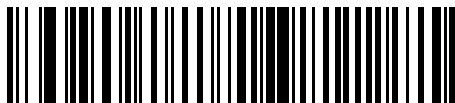

Enable Caps Lock

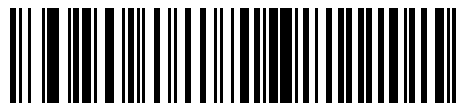

*Disable Caps Lock

Caps Lock Override

Select Enable Caps Lock Override for AT or AT Notebook hosts to preserve the case of the data regardless of the state of the Caps Lock key.

When enabled, an 'A' in the barcode transmits as an 'A' regardless of the setting of the keyboard's Caps Lock key.



NOTE: If both Simulated Caps Lock and Caps Lock Override are enabled, Caps Lock Override takes precedence.

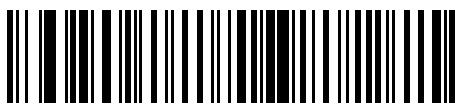

Enable Caps Lock Override

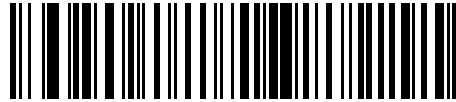

*Disable Caps Lock Override

Convert Case (Keyboard Wedge)

This parameter converts all barcode data to the selected case.



NOTE: Convert Case applies to ASCII characters only.

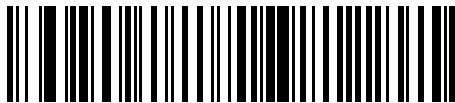

Convert to Upper Case

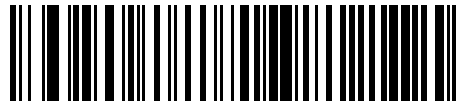

Convert to Lower Case

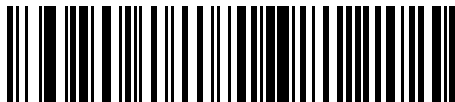

*Do Not Convert

Function Key Mapping (Keyboard Wedge)

ASCII values under 32 are normally sent as control key sequences (see [ASCII Character Sets](#)). Select Enable Function Key Mapping to send the keys in bold in place of the standard key mapping. Table entries that do not have a bold entry remain the same whether or not you enable this parameter.

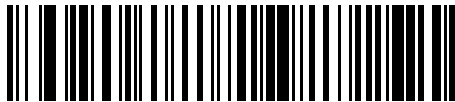

Enable Function Key Mapping

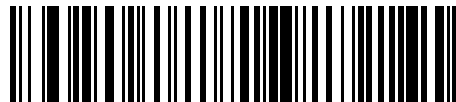

*Disable Function Key Mapping

FN1 Substitution

Select Enable FN1 Substitution to replace FN1 characters in an EAN128 barcode with a user-selected keystroke (see [FN1 Substitution Values](#)).

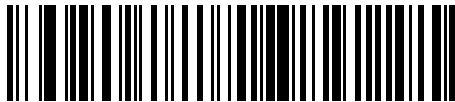

Enable FN1 Substitution



*Disable FN1 Substitution

Send Make and Break

Select Send Make and Break Scan Codes to prevent sending the scan codes for releasing a key.



NOTE: Windows-based systems must use Send Make and Break Scan Codes.

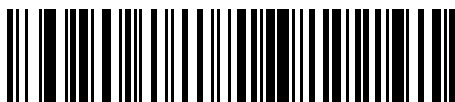

*Send Make and Break Scan Codes



Send Make Scan Code Only

Keyboard Map

The following keyboard map is a reference for prefix/suffix keystroke parameters. To program the prefix/suffix values, see the barcodes on [Prefix/Suffix Values](#).

Figure 12 IBM PS2 Type Keyboard

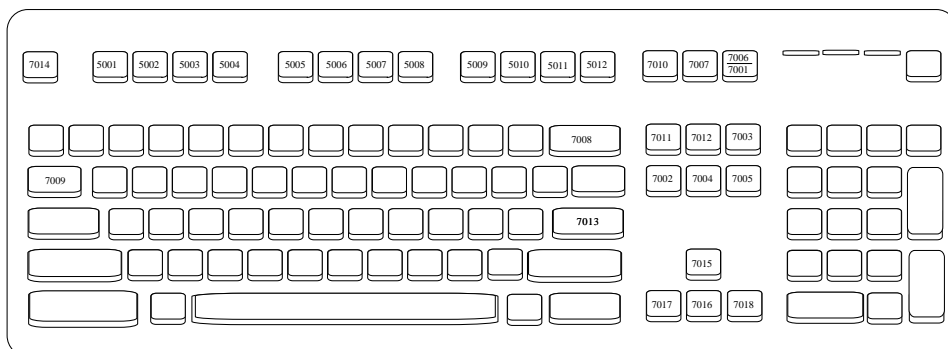

ASCII Character Sets

For character set information, review a specific character set table.

- [ASCII Character Sets](#)
- [ALT Key Character Set](#)
- [GUI Key Character Set](#)
- [PF Key Character Set](#)
- [F Key Character Set](#)
- [Numeric Key Character Set](#)
- [Extended Key Character Set](#)

Symbologies

You can program the scanner to perform various functions or activate different features.

This section describes symbology features and provides programming barcodes for selecting these features.

The scanner ships with the settings shown in the . If the default values suit requirements, programming is not necessary.

Symbology Parameter Defaults

Symbology Parameter Defaults lists the defaults for all symbology parameters.

Change these values in one of two ways:

- Choose the appropriate parameter in this section. The new value replaces the standard default value in memory. To recall the default parameter values, see [Default Parameters](#).
- Configure the scanner using the 123Scan configuration program. See [123Scan and Software Tools](#).

Table 27 Symbology Parameter Defaults

Parameter	Parameter Number ^a	SSI Number ^b	Default
Enable/Disable All Code Types			
1D Symbologies			
UPC/EAN/JAN			
UPC-A	1	01h	Enable
UPC-E	2	02h	Enable
UPC-E1	12	0Ch	Disable
EAN-8/JAN 8	4	04h	Enable
EAN-13/JAN 13	3	03h	Enable
Bookland EAN	83	53h	Disable
Bookland ISBN Format	576	F1h 40h	ISBN-10
ISSN EAN	617	F1h 69h	Disable
Decode UPC/EAN/JAN Supplementals (2 and 5 digits)	16	10h	Ignore

Symbologies

Table 27 Symbology Parameter Defaults (Continued)

Parameter	Parameter Number ^a	SSI Number ^b	Default
User-Programmable Supplementals Supplemental 1: Supplemental 2:	579580	F4h F1h 43h F4h H1h 44h	000
UPC/EAN/JAN Supplemental Redundancy	80	50h	10
UPC/EAN/JAN Supplemental AIM ID	672	F1h A0h	Combined
Transmit UPC-A Check Digit	40	28h	Enable
Transmit UPC-E Check Digit	41	29h	Enable
Transmit UPC-E1 Check Digit	42	2Ah	Enable
Transmit EAN-8 Check Digit	1882	F8 07 59h	Enable
Transmit EAN-13 Check Digit	1882	F8 07 5Ah	Enable
UPC-A Preamble	34	22h	System Character
UPC-E Preamble	35	23h	System Character
UPC-E1 Preamble	36	24h	System Character
Convert UPC-E to UPC-A	37	25h	Disable
Convert UPC-E1 to UPC-A	38	26h	Disable
EAN/JAN Zero Extend	39	27h	Disable
UCC Coupon Extended Code	85	55h	Disable
Coupon Report	730	F1h DAh	New Coupon Format
UPC Reduced Quiet Zone	1289	F8h 05h 09h	Disable
Code 128			
Code 128	8	08h	Enable
Set Length(s) for Code 128	209, 210	D1h, D2h	1 to 55
GS1-128 (formerly UCC/EAN-128)	14	0Eh	Enable
ISBT 128	84	54h	Enable
ISBT Concatenation	577	F1h 41h	Disable
Check ISBT Table	578	F1h 42h	Enable
ISBT Concatenation Redundancy	223	DFh	10
Code 128 <FNC4>	1254	F8h 04h E6h	Honor
Code 128 Security Level	751	F1h EFh	Security Level 1
Code 128 Reduced Quiet Zone	1208	F8h 04h B8h	Disable
Ignore Code 128 <FNC4>	1254	F8h 04h E6h	Disable
Code 39			
Code 39	0	00h	Enable
Trioptic Code 39	13	0Dh	Disable

Table 27 Symbology Parameter Defaults (Continued)

Parameter	Parameter Number ^a	SSI Number ^b	Default
Convert Code 39 to Code 32 (Italian Pharmacy Code)	86	56h	Disable
Code 32 Prefix	231	E7h	Disable
Set Length(s) for Code 39	18, 19	12h, 13h	1 to 55
Code 39 Check Digit Verification	48	30h	Disable
Transmit Code 39 Check Digit	43	2Bh	Disable
Code 39 Full ASCII Conversion	17	11h	Disable
Code 39 Security Level	750	F1h EEh	Security Level 1
Code 39 Reduced Quiet Zone	1209	F8h 04h B9h	Disable
Code 93			
Code 93	9	09h	Enable
Set Length(s) for Code 93	26, 27	1Ah, 1Bh	1 to 55
Code 11			
Code 11	10	0Ah	Disable
Set Lengths for Code 11	28, 29	1Ch, 1Dh	4 to 55
Code 11 Check Digit Verification	52	34h	Disable
Transmit Code 11 Check Digit(s)	47	2Fh	Disable
Interleaved 2 of 5 (ITF)			
Interleaved 2 of 5 (ITF)	6	06h	Enable
Set Lengths for I 2 of 5	22, 23	16h, 17h	6 to 55
I 2 of 5 Check Digit Verification	49	31h	Disable
Transmit I 2 of 5 Check Digit	44	2Ch	Disable
Convert I 2 of 5 to EAN 13	82	52h	Disable
Febraban	1750	F8h 06h D6h	Disable
I 2 of 5 Security Level	1121	F8h 04h 61h	Security Level 1
I 2 of 5 Reduced Quiet Zone	1210	F8h 04h BAh	Disable
Discrete 2 of 5 (DTF)			
Discrete 2 of 5	5	05h	Disable
Set Length(s) for D 2 of 5	20, 21	14h 15h	1 to 55
Codabar (NW - 7)			
Codabar	7	07h	Enable
Set Lengths for Codabar	24, 25	18h, 19h	4 to 55
CLSI Editing	54	36h	Disable

Table 27 Symbology Parameter Defaults (Continued)

Parameter	Parameter Number ^a	SSI Number ^b	Default
NOTIS Editing	55	37h	Disable
Codabar Security Level	1776	F8h 06h F0h	Security Level 1
Codabar Upper or Lower Case Start/ Stop Characters Detection	855	F2h 57h	Upper Case
MSI			
MSI	11	0Bh	Disable
Set Length(s) for MSI	30, 31	1Eh, 1Fh	4 to 55
MSI Check Digits	50	32h	One
Transmit MSI Check Digit	46	2Eh	Disable
MSI Check Digit Algorithm	51	33h	Mod 10/Mod 10
MSI Reduced Quiet Zone	1392	F8h 05h 70h	Disable
Chinese 2 of 5			
Chinese 2 of 5	408	F0h 98h	Disable
Matrix 2 of 5			
Matrix 2 of 5	618	F1h 6Ah	Disable
Set Lengths for Matrix 2 of 5	619 620	F1h 6Bh F1h 6Ch	4 to 55
Matrix 2 of 5 Check Digit	622	F1h 6Eh	Disable
Transmit Matrix 2 of 5 Check Digit	623	F1h 6Fh	Disable
Korean 3 of 5			
Korean 3 of 5	581	F1h 45h	Disable
Inverse 1D	586	F1h 4Ah	Regular
GS1 DataBar			
GS1 DataBar Omnidirectional	338	F0h 52h	Enable
GS1 DataBar Limited	339	F0h 53h	Enable
GS1 DataBar Expanded	340	F0h 54h	Enable
Convert GS1 DataBar to UPC/EAN/JAN	397	F0h 8Dh	Disable
GS1 DataBar Security Level	1706	F8h 06h AAh	Level 1
GS1 DataBar Limited Margin Check	728	F1h D8h	Level 3
GS1 DataBar Expanded Security Level	1707	F8h 06h ABh	Level 1
Symbology-Specific Security Features			
Redundancy Level	78	4Eh	1
Security Level	77	4Dh	1
1D Quiet Zone Level	1288	F8h 05h 08h	1

Symbologies

Table 27 Symbology Parameter Defaults (Continued)

Parameter	Parameter Number ^a	SSI Number ^b	Default
Intercharacter Gap Size	381	F0h 7Dh	Normal
Composite Codes			
Composite CC-C	341	F0h 55h	Disable
Composite CC-A/B	342	F0h 56h	Disable
Composite TLC-39	371	F0h 73h	Disable
Composite Inverse	1113	F8h 04h 59h	Regular
UPC Composite Mode	344	F0h 58h	UPC Never Linked
Composite Beep Mode	398	F0h 8Eh	Beep As Each Code Type is Decoded
GS1-128 Emulation Mode for UCC/EAN Composite Codes	427	F0h ABh	Disable
2D Symbologies			
PDF417	15	0Fh	Enable
MicroPDF417	227	E3h	Disable
Code 128 Emulation	123	7Bh	Disable
Data Matrix	292	F0h 24h	Enable
GS1 Data Matrix	1336	F8h 05h 38h	Disable
Data Matrix Inverse	588	F1h 4Ch	Inverse Autodetect
Decode Data Matrix Mirror Images	537	F1h 19h	Auto
Maxicode	294	F0h 26h	Disable
QR Code	293	F0h 25h	Enable
Weblink QR	1947	F8 07 9Bh	Decode Weblink QR Codes
GS1 QR	1343	F8h 05h 3Fh	Disable
MicroQR	573	F1h 3Dh	Enable
Linked QR Mode	1847	737h	Linked QR Only
Aztec	574	F1h 3Eh	Enable
Aztec Inverse	589	F1h 4Dh	Inverse Autodetect
Han Xin	1167	F8h 04h 8Fh	Disable
Han Xin Inverse	1168	F8h 04h 90h	Regular
Grid Matrix	1718	F8h 06h B6h	Disable
Grid Matrix Inverse	1719	F8h 06h B7h	Regular
Grid Matrix Mirrored	1736	F8h 06h C8h	Non-Mirrored
DotCode	1906	F8 07 72h	Disable

Table 27 Symbology Parameter Defaults (Continued)

Parameter	Parameter Number ^a	SSI Number ^b	Default
DotCode Prioritize	1937	F8 07 91h	Enable
DotCode Inverse	1907	F8 07 73h	Autodetect
DotCode Mirrored	1908	F8 07 74h	Autodetect
Macro PDF			
Escape Characters	233	E9h	None
Flush Macro PDF Buffer	N/A	N/A	N/A
Abort Macro PDF Entry	N/A	N/A	N/A
Postal Codes			
US Postnet	89	59h	Disable
US Planet	90	5Ah	Disable
Transmit US Postal Check Digit	95	5Fh	Enable
UK Postal	91	5Bh	Disable
Transmit UK Postal Check Digit	96	60h	Enable
Japan Postal	290	F0h 22h	Disable
Australia Post	291	F0h 23h	Disable
Australia Post Format	718	F1h CEh	Autodiscriminate
Netherlands KIX Code	326	F0h 46h	Disable
USPS 4CB/One Code/Intelligent Mail	592	F1h 50h	Disable
UPU FICS Postal	611	F1h 63h	Disable
Mailmark	1337	F8h 05h 39h	Disable

^a Parameter number decimal values are used for programming via RSM commands.

^b SSI number hex values are used for programming via SSI commands.

Enable/Disable All Code Types

- Disable All Code Types - Disable all symbologies. This is useful when enabling only a few code types.
- Enable All Code Types - Enable all symbologies. This is useful if you need to disable only a few code types.



Disable All Code Types



Enable All Code Types

UPC/EAN/JAN

You can choose one of these parameters to enable UPC, EAN, or JAN settings.

UPC-A

Parameter # 1 (SSI #01h)

This parameter enables or disables UPC-A.

- *Enabled - enables UPC-A.
- Disabled - disables UPC-A.

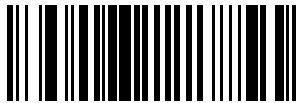

*Enable UPC-A (1)

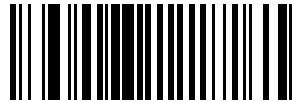

Disable UPC-A (0)

UPC-E

Parameter # 2 (SSI # 02h)

This parameter enables UPC-E.

- *Enabled - this sets UPC-E to use.
- Disabled - UPC-E is no longer in use.



*Enable UPC-E (1)

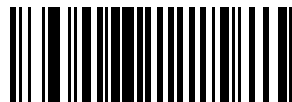

Disable UPC-E (0)

UPC-E1

Parameter # 12 (SSI # 0Ch)

This parameter enables UPC-E1.

- Enabled - This sets UPC-E1 to use.
- Disabled - UPC-E1 is no longer in use.



NOTE: UPC-E1 is not a UCC (Uniform Code Council) approved symbology.

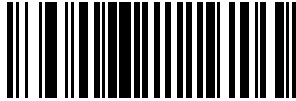

Enable UPC-E1 (1)

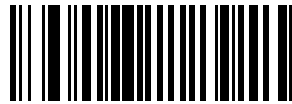

*Disable UPC-E1 (0)

EAN-8/JAN-8

Parameter # 4 (SSI # 04h)

This parameter enables EAN-8/JAN-8.

- Enabled - Sets EAN-8/JAN-8 for use.
- Disabled - EAN-8/JAN-8 is no longer in use.



*Enable EAN-8/JAN-8 (1)

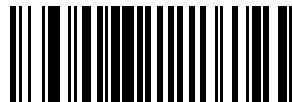

Disable EAN-8/JAN-8 (0)

EAN-13/JAN-13

Parameter # 3 (SSI # 03h)

This parameter enables EAN-13/JAN-13.

- Enabled - Sets EAN-13/JAN-13 for use.
- Disabled - EAN-13/JAN-13 is no longer in use.

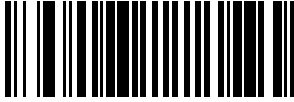

*Enable EAN-13/JAN-13 (1)

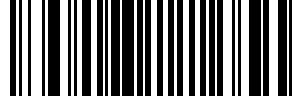

Disable EAN-13/JAN-13 (0)

Bookland EAN

Parameter # 83 (SSI # 53h)

This parameter enables Bookland EAN.

- Enabled - This sets Bookland EAN for use.
- Disabled - Bookland EAN is no longer in use.



NOTE: If you enable Bookland EAN, select a [Bookland ISBN Format](#). Also set [Decode UPC/EAN/JAN Supplementals](#) to either Decode UPC/EAN/JAN with Supplementals Only, Autodiscriminate UPC/EAN/JAN With Supplementals, or Enable 978/979 Supplemental Mode.

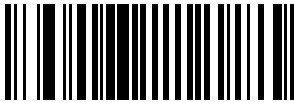

Enable Bookland EAN (1)

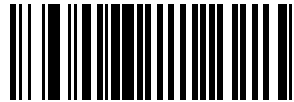

*Disable Bookland EAN (0)

Bookland ISBN Format

Parameter # 576 (SSI # F1h 40h)

If Bookland EAN is enabled, this parameter allows you to choose a format for Bookland data.

- *Bookland ISBN-10 - The scanner reports Bookland data starting with 978 in traditional 10-digit format with the special Bookland check digit for backward-compatibility. Data starting with 979 is not considered Bookland in this mode.
- Bookland ISBN-13 - The scanner reports Bookland data (starting with either 978 or 979) as EAN-13 in 13-digit format to meet the 2007 ISBN-13 protocol.



NOTE: For Bookland EAN to function properly, first enable [Bookland EAN](#) and then set [Decode UPC/EAN/JAN Supplementals](#) to either Decode UPC/EAN/JAN with Supplementals Only, Autodiscriminate UPC/EAN/JAN With Supplementals, or Enable 978/979 Supplemental Mode.



*Bookland ISBN-10 (0)

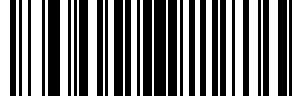

Bookland ISBN-13 (1)

ISSN EAN

Parameter # 617 (SSI # F1h 69h)

This parameter enables ISSN EAN.

- Enabled - Sets ISSN EAN for use.
- *Disabled - ISSN EAN is no longer in use.

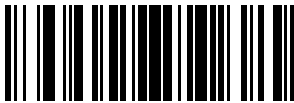

Enable ISSN EAN (1)



*Disable ISSN EAN (0)

Decode UPC/EAN/JAN Supplementals

Parameter # 16 (SSI # 10h)

This parameter decodes supplementals, which are barcodes appended according to specific format conventions (for example, UPC A+2, UPC E+2, EAN 13+2). .

- Decode UPC/EAN/JAN with Supplementals Only - The scanner only decodes UPC/EAN/JAN symbols with supplemental characters, and ignores symbols without supplementals.
- Ignore UPC/EAN/JAN Supplementals - When presented with a UPC/EAN/JAN plus supplemental symbol, the scanner decodes UPC/EAN/JAN and ignores the supplemental characters.
- Autodiscriminate UPC/EAN/JAN with Supplementals - The scanner decodes UPC/EAN/JAN symbols with supplemental characters immediately. If the symbol does not have a supplemental, the scanner must decode the barcode the number of times set via [UPC/EAN/JAN Supplemental Redundancy](#) before transmitting its data to confirm that there is no supplemental.
- Enable 378/379 Supplemental Mode
- Enable 978/979 Supplemental Mode



NOTE: If you select 978/979 Supplemental Mode and are scanning Bookland EAN barcodes, see [Bookland EAN](#), and select a format using [Bookland ISBN Format](#).

- Enable 977 Supplemental Mode
- Enable 414/419/434/439 Supplemental Mode
- Enable 491 Supplemental Mode
- Enable Smart Supplemental Mode - This applies to EAN-13 barcodes starting with any prefix listed previously.
- Supplemental User-Programmable Type 1 - This applies to EAN-13 barcodes starting with a 3-digit user-defined prefix. Set this using [User Programmable Supplementals](#).
- Supplemental User-Programmable Type 1 and 2 - This applies to EAN-13 barcodes starting with either of two 3-digit user-defined prefixes. Set the prefixes using [User Programmable Supplementals](#).
- Smart Supplemental Plus User-Programmable 1 - This applies to EAN-13 barcodes starting with any prefix listed previously or the prefix set using [User Programmable Supplementals](#).
- Smart Supplemental Plus User-Programmable 1 and 2 - This applies to EAN-13 barcodes starting with any prefix listed previously or one of the two user-defined prefixes set using [User Programmable Supplementals](#).



NOTE: To minimize the risk of invalid data transmission, select either to decode or ignore supplemental characters.



Decode UPC/EAN/JAN With Supplementals Only (1)



*Ignore UPC/EAN/JAN Supplementals (0)



Autodiscriminate UPC/EAN/JAN with Supplementals (2)

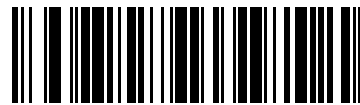

Enable 378/379 Supplemental Mode (4)



Enable 978/979 Supplemental Mode (5)



Enable 414/419/434/439 Supplemental Mode (6)



Enable 977 Supplemental Mode (7)



Enable 491 Supplemental Mode (8)



Enable Smart Supplemental Mode (3)

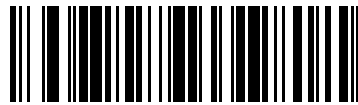

Supplemental User-Programmable Type 1 (9)



Supplemental User-Programmable Type 1 and 2 (10)

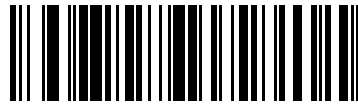

Smart Supplemental Plus User-Programmable 1 (11)



Smart Supplemental Plus User-Programmable 1 and 2 (12)

User-Programmable Supplementals

Parameter # 579 (SSI # F4h F1h 43h)

Parameter # 580 (SSI # F4h F1h 44h)

If you selected a Supplemental User-Programmable option, this parameter allows you to set two 3-digit prefixes.

- User-Programmable Supplemental 1 - Sets the first 3-digit prefix. See [Numeric Barcodes](#).

- User-Programmable Supplemental 2 - Sets a 2nd 3-digit prefix, if necessary. See [Numeric Barcodes](#).

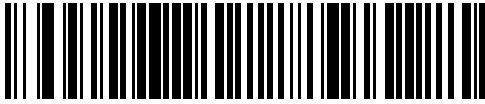

User-Programmable Supplemental 1



User-Programmable Supplemental 2

UPC/EAN/JAN Supplemental Redundancy

Parameter # 80 (SSI # 50h)

If you selected Autodiscriminate UPC/EAN/JAN with Supplementals, this option sets the number of times to decode a symbol without supplementals before transmission. You can enable audio feedback during a reconnect attempt.

The range is from 2-30. Five or above is recommended when decoding a mix of UPC/EAN/JAN symbols with and without supplementals.

To set a redundancy value, scan the following barcode, and then scan two barcodes from [Numeric Barcodes](#). Enter a leading zero for single digit numbers. To correct an error or change a selection, scan [Cancel](#).

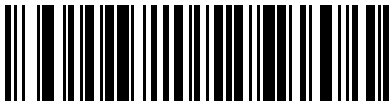

UPC/EAN/JAN Supplemental Redundancy

UPC/EAN/JAN Supplemental AIM ID Format

Parameter # 672 (SSI # F1h A0h)

If Transmit Code ID Character is set to **AIM Code ID Character**, select an output format when reporting UPC/EAN/JAN barcodes with supplementals.

- Separate - Transmit UPC/EAN/JAN with supplementals with separate AIM IDs but one transmission, for example,

```
]E<0 or 4><data>]E<1 or 2>[supplemental data]
```

- Combined - Transmit UPC/EAN/JAN with supplementals with one AIM ID and one transmission. For example, see below.

```
]E3<data+supplemental data>
```

- Separate Transmissions - Transmit UPC/EAN/JAN with supplementals with separate AIM IDs and separate transmissions, for example,

```
]E<0 or 4><data>  
]E<1 or 2>[supplemental data]
```



Separate (0)



*Combined (1)



Separate Transmissions (2)

Transmit UPC-A Check Digit

Parameter # 40 (SSI # 28h)

This parameter transmits data with or without the UPC-A check digit.

The check digit is the last character of the symbol used to verify the integrity of the data. It is always verified to guarantee the integrity of the data.

- *Transmit UPC-A Check Digit - Transmits the data with the UPC-A check digit.
- Do Not Transmit UPC-A Check Digit - Transmits the data without the UPC-A check digit.



*Transmit UPC-A Check Digit (1)

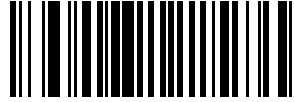

Do Not Transmit UPC-A Check Digit (0)

Transmit UPC-E Check Digit

Parameter # 41 (SSI # 29h)

This parameters transmits data with or without the UPC-E check digit.

The check digit is the last character of the symbol used to verify the integrity of the data. It is always verified to guarantee the integrity of the data.

- *Transmit UPC-E Check Digit - transmits the data with the UPC-E check digit.
- Do Not Transmit UPC-E Check Digit - transmits the data without the UPC-E check digit.

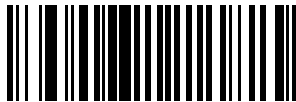

*Transmit UPC-E Check Digit (1)

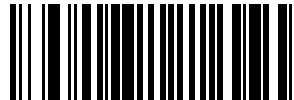

Do Not Transmit UPC-E Check Digit (0)

Transmit UPC-E1 Check Digit

Parameter # 42 (SSI #2Ah)

This parameters transmits data with or without the UPC-E1 check digit.

The check digit is the last character of the symbol used to verify the integrity of the data. It is always verified to guarantee the integrity of the data.

- *Transmit UPC-E1 Check Digit - Transmits the data with the UPC-E1 check digit.
- Do Not Transmit UPC-E1 Check Digit - Transmits the data without the UPC-E1 check digit.



*Transmit UPC-E1 Check Digit (1)

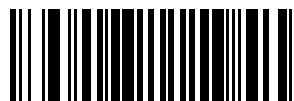

Do Not Transmit UPC-E1 Check Digit (0)

Transmit EAN-8 Check Digit

Parameter # 1881 (SSI # F8 07 59h)

This parameter transmits data with or without the EAN-8 check digit.

The check digit is the last character of the symbol used to verify the integrity of the data. Scan one of the following barcodes to transmit the barcode data with or without the EAN-8 check digit. It is always verified to guarantee the integrity of the data.



*Transmit EAN-8 Check Digit (1)



Do Not Transmit EAN-8 Check Digit (0)

Transmit EAN-13 Check Digit

Parameter # 1882 (SSI # F8h 07 5Ah)

This parameter transmits data with or without the EAN-13 check digit.

The check digit is the last character of the symbol used to verify the integrity of the data. Scan one of the following barcodes to transmit the barcode data with or without the EAN-13 check digit. It is always verified to guarantee the integrity of the data.

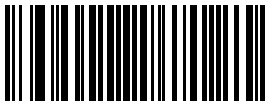

*Transmit EAN-13 Check Digit (1)



Do Not Transmit EAN-13 Check Digit (0)

UPC-A Preamble

Parameter # 34 (SSI # 22h)

Preamble characters are part of the UPC symbol, and include Country Code and System Character.

Select the appropriate option for transmitting a UPC-A preamble to match the host system:

- Transmit System Character only
- Transmit System Character and Country Code ("0" for USA)
- Transmit no preamble.

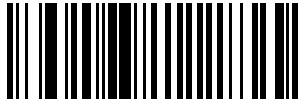

No Preamble (<DATA>) (0)



*System Character (<SYSTEM CHARACTER>
<DATA>) (1)



System Character & Country Code (< COUNTRY
CODE> <SYSTEM CHARACTER> <DATA>) (2)

UPC-E Preamble

Parameter # 35 (SSI # 23h)

Preamble characters are part of the UPC symbol, and include Country Code and System Character.

Select the appropriate option for transmitting a UPC-E preamble to match the host system:

- Transmit System Character only
- Transmit System Character and Country Code (“0” for USA)
- Transmit no preamble.

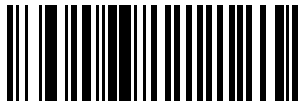

No Preamble (<DATA>) (0)

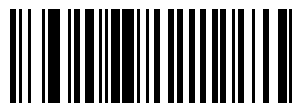

*System Character (<SYSTEM CHARACTER>
<DATA>) (1)



System Character & Country Code (< COUNTRY
CODE> <SYSTEM CHARACTER> <DATA>) (2)

UPC-E1 Preamble

Parameter # 36 (SSI # 24h)

Preamble characters are part of the UPC symbol, and include Country Code and System Character.

Select the appropriate option for transmitting a UPC-E1 preamble to match the host system:

- Transmit System Character only
- Transmit System Character and Country Code ("0" for USA)
- Transmit no preamble.

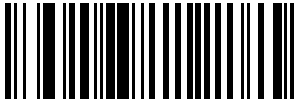

No Preamble (<DATA>) (0)



*System Character (<SYSTEM CHARACTER> <DATA>) (1)

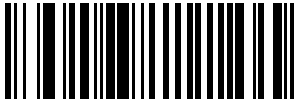

System Character & Country Code (< COUNTRY CODE> <SYSTEM CHARACTER> <DATA>) (2)

Convert UPC-E to UPC-A

Parameter # 37 (SSI # 25h)

This parameter converts UPC-E (zero suppressed) decoded data to UPC-A format before transmission.

After conversion, the data follows UPC-A format and is affected by UPC-A programming selections (such as, Preamble, Check Digit).

- *Enabled - Converts UPC-E decoded data to UPC-A format.
- Disabled - Transmits UPC-E decoded data without conversion to UPC-A.

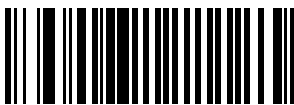

Convert UPC-E to UPC-A (Enable) (1)

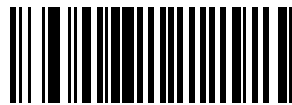

*Do Not Convert UPC-E to UPC-A (Disable) (0)

Convert UPC-E1 to UPC-A

Parameter # 38 (SSI # 26h)

This parameter converts UPC-E1 (zero suppressed) decoded data to UPC-A format before transmission. After conversion, the data follows UPC-A format and is affected by UPC-A programming selections (for example, Preamble, Check Digit).

- *Enabled - converts UPC-E1 decoded data to UPC-A format.
- Disabled - transmits UPC-E1 decoded data without conversion to UPC-A.

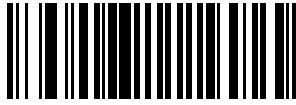

Convert UPC-E1 to UPC-A (Enable) (1)

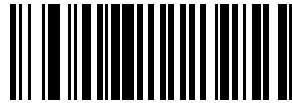

*Do Not Convert UPC-E1 to UPC-A (Disable) (0)

EAN/JAN Zero Extend

Parameter # 39 (SSI # 27h)

This parameter enables or disables decoded EAN-8 symbols to be compatible in length with EAN-13 symbols.

- Enabled - Adds five leading zeros to decoded EAN-8 symbols to make them compatible in length to EAN-13 symbols
- Disabled - Transmits EAN-8 symbols as-is, without adding zeroes.

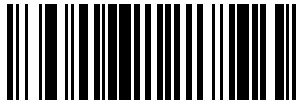

Enable EAN/JAN Zero Extend (1)

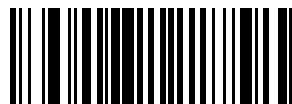

*Disable EAN/JAN Zero Extend (0)

UCC Coupon Extended Code

Parameter # 85 (SSI # 55h)

This parameter decodes UPC-A barcodes starting with digit '5', EAN-13 barcodes starting with digit '99', and UPC-A/GS1-128 coupon codes.

- Enabled - Extends decoding for UPC-A, EAN-13, and GS1-128 coupon codes.
- *Disabled - Does not extend decoding for UPC-A, EAN-13, and GS1-128 coupon codes.



NOTE: UPC-A, EAN-13, and GS1-128 must be enabled to use this feature.



NOTE: See [UPC/EAN/JAN Supplemental Redundancy](#) to control autodiscrimination of the GS1-128 portion (right half) of a coupon code.

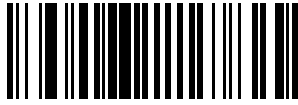

Enable UCC Coupon Extended Code (1)

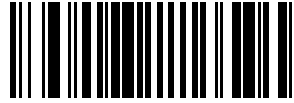

*Disable UCC Coupon Extended Code (0)

Coupon Report

Parameter # 730 (SSI # F1h DAh)

This parameter selects the type of coupon format to support.

- Old Coupon Format - Support UPC-A/GS1-128 and EAN-13/GS1-128.
- New Coupon Format - An interim format to support UPC-A/GS1-DataBar and EAN-13/GS1-DataBar.
- Autodiscriminate Format - Support both Old Coupon Format and New Coupon Format.



Old Coupon Format (0)

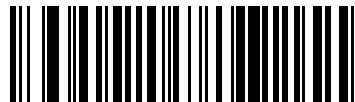

*New Coupon Format (1)



Autodiscriminate Coupon Format (2)

UPC Reduced Quiet Zone

Parameter # 1289 (SSI # F8h 05h 09h)

This parameter enables or disables decoding UPC barcodes with reduced quiet zones (the margins on either side of the barcode).

- Enabled - Enables decoding UPC barcodes with reduced quiet zones.
- *Disabled - Disables decoding UPC barcodes with reduced quiet zones.



NOTE: If you select Enable, select a [1D Quiet Zone Level](#).

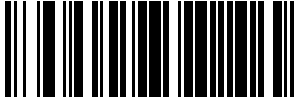

Enable UPC Reduced Quiet Zone (1)



*Disable UPC Reduced Quiet Zone (0)

Code 128

Parameter # 8 (SSI #08h)

You can enable or disable Code 128.

- *Enabled - Enables Code 128.
- Disabled - Disables Code 128.

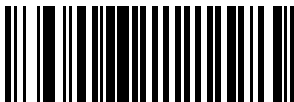

*Enable Code 128 (1)

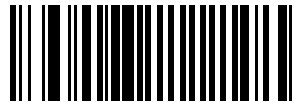

Disable Code 128 (0)

Set Lengths for Code 128

Parameter # 209 (SSI #D1h)

Parameter # 210 (SSI #D2h)

This parameter sets lengths for Code 128 to any length, one or two discrete lengths, or lengths within a specific range.

The length of a code refers to the number of characters (for example, human-readable characters), including check digit(s) the code contains. The default is Any Length.



NOTE: When setting lengths, enter a leading zero for single digit numbers.

- One Discrete Length - Decode only Code 128 symbols containing a selected length.
- Two Discrete Lengths - Decode only Code 128 symbols containing either of two lengths.
- Length Within Range - Decode Code 128 symbols with a specific length range.
- Any Length - Decode Code 128 symbols containing any number of characters within the scanner's capability.

Select lengths using barcodes in [Numeric Barcodes](#). To correct an error or change the selection, scan [Cancel](#).

For example:

- To decode only Code 128 symbols with 14 characters, scan Code 128 - One Discrete Length, and then scan 1, 4.
- To decode only Code 128 symbols containing either 2 or 14 characters, scan Code 128 - Two Discrete Lengths, and then scan 0, 2, 1, 4.
- To decode Code 128 symbols containing between 4 and 12 characters, scan Code 128 - Length Within Range, and then scan 0, 4, 1, 2.

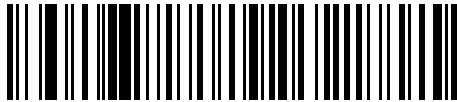

Code 128 - One Discrete Length



Code 128 - Two Discrete Lengths

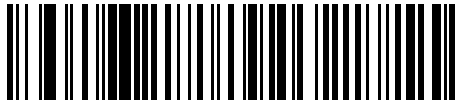

Code 128 - Length Within Range (Default: Any Length)



*Code 128 - Any Length

GS1-128 (formerly UCC/EAN-128)

Parameter # 14 (SSI #0Eh)

You can enable or disable GS1-128.

- *Enabled - Enables GS1-128.
- Disabled - Disables GS1-128.



*Enable GS1-128 (1)

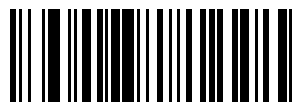

Disable GS1-128 (0)

ISBT 128

Parameter # 84 (SSI #54h)

You can enable or disable ISBT 128.

- *Enabled - enables ISBT 128.
- Disabled - disables ISBT 128.

ISBT 128 is a variant of Code 128 used in the blood bank industry.

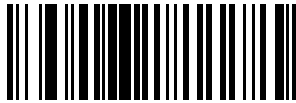

*Enable ISBT 128 (1)

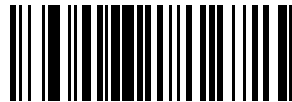

Disable ISBT 128 (0)

ISBT Concatenation

Parameter # 577 (SSI #F1h 41h)

This parameter enables and disables ISBT concatenation.

Select an option for concatenating pairs of ISBT code types:

- Enable ISBT Concatenation - There must be two ISBT codes in order for the scanner to decode and perform concatenation. The scanner does not decode single ISBT symbols.
- Disable ISBT Concatenation - The scanner does not concatenate pairs of ISBT codes it encounters.
- Autodiscriminate ISBT Concatenation - The scanner decodes and concatenates pairs of ISBT codes immediately. If only a single ISBT symbol is present, the scanner must decode the symbol the number of times set via [ISBT Concatenation Redundancy](#) before transmitting its data to confirm that there is no additional ISBT symbol.



NOTE: For ISBT AutoDetect to operate as expected, both barcodes must be in the field of view simultaneously. This may be difficult to achieve in presentation mode.



NOTE: When enabling ISBT Concatenation or Autodiscriminate ISBT Concatenation set Code 128 Security Level to Level 2.



Enable ISBT Concatenation (1)



*Disable ISBT Concatenation (0)

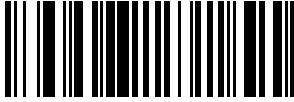

Autodiscriminate ISBT Concatenation (2)

Check ISBT Table

Parameter # 578 (SSI #F1h 42h)

This parameter enables or disables the Check ISBT Table to concatenate only those pairs found in this table. Other types of ISBT codes are not concatenated.

- *Enabled - enables the Check ISBT Table to concatenate only those pairs found in this table.
- Disabled - disables the Check ISBT Table to concatenate only those pairs found in this table.

The ISBT specification includes a table that lists several types of ISBT barcodes that are commonly used in pairs.

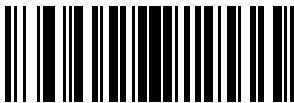

*Enable Check ISBT Table (1)

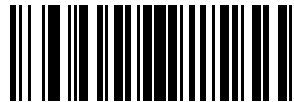

Disable Check ISBT Table (0)

ISBT Concatenation Redundancy

Parameter # 223 (SSI #DFh)

This parameter sets the number of times the scanner must decode an ISBT symbol before determining that there is no additional symbol.

This parameter applies if you set ISBT Concatenation to Autodiscriminate.

Scan the following barcode, and then scan barcodes in [Numeric Barcodes](#) to set a value between 2 and 20. Enter a leading zero for single-digit numbers. To correct an error or change a selection, scan [Cancel](#). The default is 10.

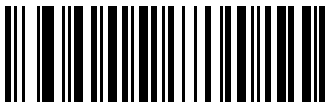

ISBT Concatenation Redundancy

Code 128 <FNC4>

Parameter # 1254 (SSI #F8h 04h E6h)

This parameter processes the Code 128 <FNC4> character, and either ignores (removes) the character or honors (does not remove) the character.

- *Honor Code 128 <FNC4> - The <FNC4> character is processed normally, per Code 128 standard.
- Ignore Code 128 <FNC4> - Strips the <FNC4> character from the decode data. The remaining characters are sent to the host unchanged.

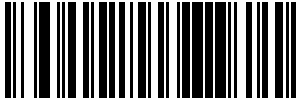

*Honor Code 128 <FNC4> (0)

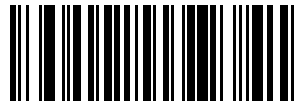

Ignore Code 128 <FNC4> (1)

Code 128 Security Level

Parameter # 751 (SSI #F1h EFh)

This parameter enables four levels of decode security for Code 128.

Code 128 barcodes are vulnerable to misdecodes, particularly when Code 128 Lengths is set to Any Length. There is an inverse relationship between security and scanner aggressiveness. Increasing the level of security can reduce scanning aggressiveness, so select only the level of security necessary.

- Code 128 Security Level 0 - The scanner operates in its most aggressive state, while providing sufficient security in decoding most in-spec barcodes.
- Code 128 Security Level 1 - This option eliminates most misdecodes while maintaining reasonable aggressiveness.
- Code 128 Security Level 2 - This option applies greater barcode security requirements if Security Level 1 fails to eliminate misdecodes.
- Code 128 Security Level 3 - If you selected Security Level 2, and misdecodes still occur, select this security level to apply the highest safety requirements.



NOTE: Selecting Code 128 Security Level 3 is an extreme measure against mis-decoding severely out-of-spec barcodes, and significantly impairs the decoding ability of the device. If this level of security is required, try to improve the quality of the barcodes.

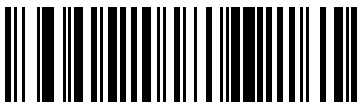

Code 128 Security Level 0 (0)



*Code 128 Security Level 1 (1)



Code 128 Security Level 2 (2)

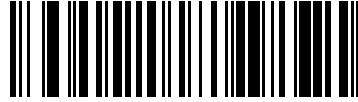

Code 128 Security Level 3 (3)

Code 128 Reduced Quiet Zone

Parameter # 1208 (SSI #F8h 04h B8h)

This parameter enables or disables decoding Code 128 with reduced quiet zones (the margins on either side of the barcode).

If you select Enable, select a [1D Quiet Zone Level](#).

- Enabled - enables Code 128 with reduced Quiet Zones.
- *Disabled - disables Code 128 with reduced Quiet Zones.

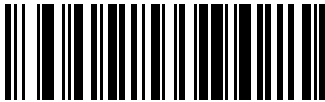

Enable Code 128 Reduced Quiet Zone (1)

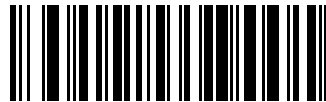

*Disable Code 128 Reduced Quiet Zone (0)

Ignore Code 128 <FNC4>

Parameter # 1254 (SSI #F8h 04h E6h)

This feature applies to Code 128 bar codes with an embedded <FNC4> character. Enable this to strip the <FNC4> character from the decode data.

The remaining characters are sent to the host unchanged. When disabled, the <FNC4> character is processed normally as per Code 128 standard.

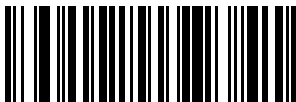

Enable Ignore Code 128 <FNC4> (1)



*Disable Ignore Code 128 <FNC4> (0)

Code 39

Parameter # 0 (SSI #00h)

This parameter enables or disables Code 39.

- *Enabled - Enables Code 39.
- Disabled - Disables Code 39.

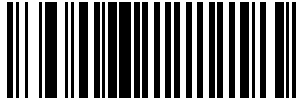

*Enable Code 39 (1)

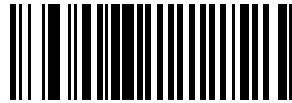

Disable Code 39 (0)

Trioptic Code 39

Parameter # 13 (SSI #0Dh)

This parameter enables or disables Trioptic Code 39.

Trioptic Code 39 is a variant of Code 39 used in the marking of computer tape cartridges. Trioptic Code 39 symbols always contain six characters.

- Enabled - enables Trioptic Code 39.
- *Disabled - disables Trioptic Code 39.



NOTE: You cannot enable Trioptic Code 39 and Code 39 Full ASCII simultaneously.



Enable Trioptic Code 39 (1)

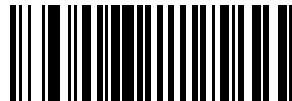

*Disable Trioptic Code 39 (0)

Convert Code 39 to Code 32

Parameter # 86 (SSI #5h)

This parameter enables or disables converting Code 39 to Code 32.

Code 32 is a variant of Code 39 used by the Italian pharmaceutical industry.



NOTE: Code 39 must be enabled for this parameter to function.

- Enabled - enables Convert Code 39 to Code 32.
- *Disabled - disables Convert Code 39 to Code 32.



Enable Convert Code 39 to Code 32 (1)

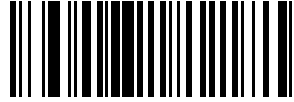

*Disable Convert Code 39 to Code 32 (0)

Code 32 Prefix

Parameter # 231 (SSI #E7h)

This parameter enables or disables adding the prefix character “A” to all Code 32 barcodes.

- Enabled - enables Code 32 Prefix.
- *Disabled - disables Code 32 Prefix.



NOTE: [Convert Code 39 to Code 32](#) must be enabled for this parameter to function.

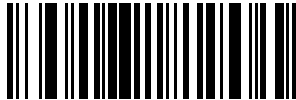

Enable Code 32 Prefix (1)

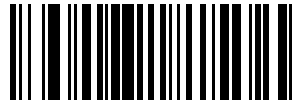

*Disable Code 32 Prefix (0)

Set Lengths for Code 39

L1 Parameter # 18 (SSI #12h)

L2 Parameter # 19 (SSI #13h)

This parameter sets lengths for Code 39.

The length of a code refers to the number of characters (for example, human readable characters), including check digit(s) the code contains. Set lengths for Code 39 to any length, one or two discrete lengths, or lengths within a specific range. If Code 39 Full ASCII is enabled, Length Within Range or Any Length are the preferred options. The default is 1 to 55.



NOTE: When setting lengths, enter a leading zero for single digit numbers.

- One Discrete Length - Decode only Code 39 symbols containing a selected length.
- Two Discrete Lengths - Decode only Code 39 symbols containing either of two lengths.
- Length Within Range - Decode Code 39 symbols with a specific length range.
- Any Length - Decode Code 39 symbols containing any number of characters within the scanner's capability.

Select lengths using barcodes in [Numeric Barcodes](#). To correct an error or change the selection, scan [Cancel](#).

For example:

- To decode only Code 39 symbols with 14 characters, scan Code 39 - One Discrete Length, and then scan 1, 4.
- To decode only Code 39 symbols containing either 2 or 14 characters, scan Code 39 - Two Discrete Lengths, and then scan 0, 2, 1, 4.
- To decode Code 39 symbols containing between 4 and 12 characters, scan Code 39 - Length Within Range, and then scan 0, 4, 1, 2.

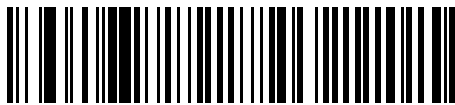

Code 39 - One Discrete Length

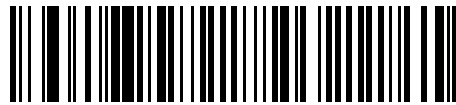

Code 39 - Two Discrete Lengths

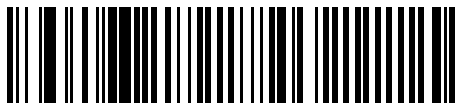

*Code 39 - Length Within Range (Default: 1 to 55)

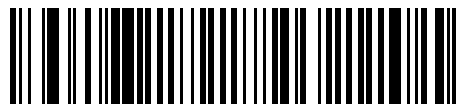

Code 39 - Any Length

Code 39 Check Digit Verification

Parameter # 48 (SSI #30h)

This parameter checks the integrity of all Code 39 symbols to verify that the data complies with specified check digit algorithm.

Only Code 39 symbols which include a modulo 43 check digit are decoded. Enable this feature if the Code 39 symbols contain a Modulo 43 check digit.

- Enabled - enables Code 39 Check Digit.

- *Disabled - disables Code 39 Check Digit.

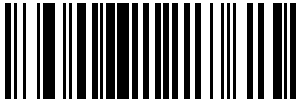

Enable Code 39 Check Digit (1)

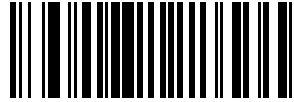

*Disable Code 39 Check Digit (0)

Transmit Code 39 Check Digit

Parameter # 43 (SSI #2Bh)

This parameter transmits Code 39 data with or without the check digit.

- Enabled - enables Transmit Code 39 Check Digit.
- *Disabled - disables Transmit Code 39 Check Digit.



NOTE: [Code 39 Check Digit Verification](#) must be enabled for this parameter to function.

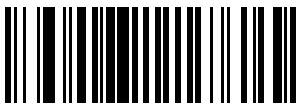

Transmit Code 39 Check Digit (Enable) (1)

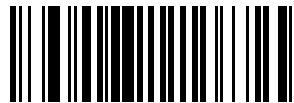

*Do Not Transmit Code 39 Check Digit (Disable) (0)

Code 39 Full ASCII Conversion

Parameter # 17 (SSI #11h)

This parameter enables or disables Code 39 Full ASCII.

Code 39 Full ASCII is a variant of Code 39 which pairs characters to encode the full ASCII character set.

- Enabled - enables Code 39 Full ASCII.
- *Disabled - disables Code 39 Full ASCII.



NOTE: You cannot enable Trioptic Code 39 and Code 39 Full ASCII simultaneously.



NOTE: Code 39 Full ASCII to Full ASCII Correlation is host-dependent, and is therefore described in the ASCII character set table for the appropriate interface. See [ASCII Character Sets](#).

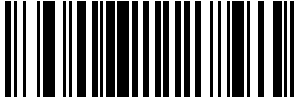

Enable Code 39 Full ASCII (1)

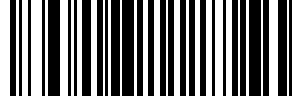

*Disable Code 39 Full ASCII (0)

Code 39 Security Level

Parameter # 750 (SSI #F1h EEh)

This parameter sets the security level for Code 39.

Select increasing levels of security for decreasing levels of barcode quality. There is an inverse relationship between security, and device aggressiveness, so choose only that level of security necessary for any given application.

- Code 39 Security Level 0 - Allows the device to operate in its most aggressive state, while providing sufficient security in decoding most "in-spec" barcodes.
- *Code 39 Security Level 1 - This setting eliminates most mis-decodes
- Code 39 Security Level 2 - Select this option if Security Level 1 fails to eliminate mis-decodes.
- Code 39 Security Level 3 - If you selected Security Level 2 and mis-decodes still occur, select this security level.



NOTE: Selecting Security Level 3 is an extreme measure against mis-decoding severely out of spec barcodes. Selecting this level of security significantly impairs the decoding ability of the device. If you need this level of security, try to improve the quality of the barcodes.

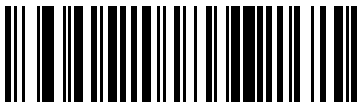

Code 39 Security Level 0 (0)



*Code 39 Security Level 1 (1)



Code 39 Security Level 2 (2)



Code 39 Security Level 3 (3)

Code 39 Reduced Quiet Zone

Parameter # 1209 (SSI #F8h 04h B9h)

This parameter enables or disables decoding Code 39 with reduced quiet zones (the margins on either side of the barcode).

If you select Enable, select a [1D Quiet Zone Level](#).

- Enabled - enables Code 39 with reduced Quiet Zones.
- *Disabled - disables Code 39 with reduced Quiet Zones.



Enable Code 39 Reduced Quiet Zone (1)



*Disable Code 39 Reduced Quiet Zone (0)

Code 93

Parameter # 9 (SSI #09h)

This parameter enables or disables Code 93.

- *Enabled - enables Code 93.
- Disabled - disables Code 93.

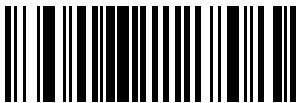

*Enable Code 93 (1)

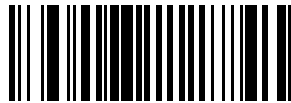

Disable Code 93 (0)

Set Lengths for Code 93

Parameter # 26 (SSI #1Ah)

Parameter # 27 (SSI #1Bh)

This parameter sets the lengths for Code 93 to any length, one or two discrete lengths, or lengths within a specific range.

The length of a code refers to the number of characters (for example, human-readable characters), including check digit(s) the code contains. The default is 1 to 55.



NOTE: When setting lengths, enter a leading zero for single-digit numbers.

- One Discrete Length - Decode only Code 93 symbols containing a selected length.
- Two Discrete Lengths - Decode only Code 93 symbols containing either of two lengths.
- Length Within Range - Decode Code 93 symbols with a specific length range.
- Any Length - Decode Code 93 symbols containing any number of characters within the scanner's capability.

Select lengths using barcodes in [Numeric Barcodes](#). To correct an error or change the selection, scan [Cancel](#).

For example:

- To decode only Code 93 symbols with 14 characters, scan Code 93 - One Discrete Length, and then scan 1, 4.
- To decode only Code 93 symbols containing either 2 or 14 characters, scan Code 93 - Two Discrete Lengths, and then scan 0, 2, 1, 4.
- To decode Code 93 symbols containing between 4 and 12 characters, scan Code 93 - Length Within Range, and then scan 0, 4, 1, 2.

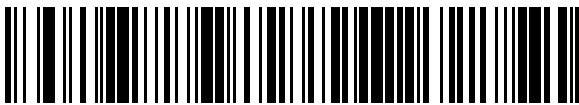

Code 93 - One Discrete Length



Code 93 - Two Discrete Lengths

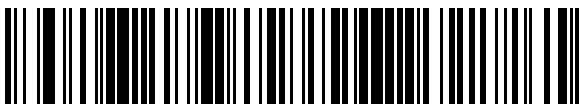

*Code 93 - Length Within Range (Default:)



Code 93 - Any Length

Code 11

Parameter # 10 (SSI #0Ah)

This parameter enables or disables Code 11.

- Enabled - enables Code 11.
- *Disabled - disables Code 11.

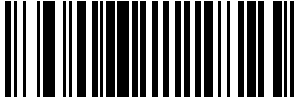

Enable Code 11 (1)

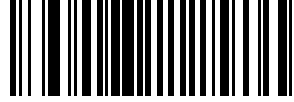

*Disable Code 11 (0)

Set Lengths for Code 11

L1 Parameter # 28 (SSI #1Ch)

L2 Parameter # 29 (SSI #1Dh)

This parameter set lengths for Code 11.

The length of a code refers to the number of characters (i.e., human readable characters), including check digit(s) the code contains. Set lengths for Code 11 to any length, one or two discrete lengths, or lengths within a specific range. The default is 4 to 55.



NOTE: When setting lengths, enter a leading zero for single digit numbers.

- One Discrete Length - Decode only Code 11 symbols containing a selected length.
- Two Discrete Lengths - Decode only Code 11 symbols containing either of two lengths.
- Length Within Range - Decode Code 11 symbols with a specific length range.
- Any Length - Decode Code 11 symbols containing any number of characters within the scanner's capability.

Select lengths using barcodes in [Numeric Barcodes](#). To correct an error or change the selection, scan [Cancel](#).

For example:

- To decode only Code 11 symbols with 14 characters, scan Code 11 - One Discrete Length, and then scan 1, 4.
- To decode only Code 11 symbols containing either 2 or 14 characters, scan Code 11 - Two Discrete Lengths, and then scan 0, 2, 1, 4.
- To decode Code 11 symbols containing between 4 and 12 characters, scan Code 11 - Length Within Range, and then scan 0, 4, 1, 2.

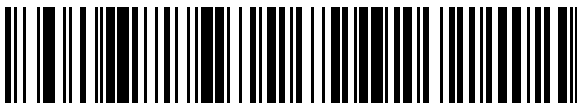

Code 11 - One Discrete Length



Code 11 - Two Discrete Lengths



*Code 11 - Length Within Range (Default: Any Length)

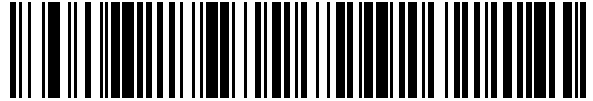

Code 11 - Any Length

Transmit Code 11 Check Digits

Parameter # 47 (SSI #2Fh)

This parameter transmits Code 11 data with or without the check digit.

- Enabled - enables Transmit Code 11 Check Digit.
- *Disabled - disables Transmit Code 11 Check Digit.



NOTE: [Code 11 Check Digit Verification](#) must be enabled for this parameter to function.

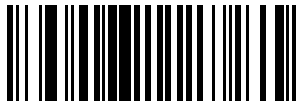

Transmit Code 11 Check Digit(s) (Enable) (1)

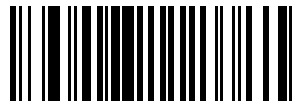

*Do Not Transmit Code 11 Check Digit(s) (Disable) (0)

Code 11 Check Digit Verification

Parameter # 52 (SSI #34h)

This parameter checks the integrity of all Code 11 symbols to verify that the data complies with specified check digit algorithm.

- *Disabled - disables Code 11 Check Digit.
- One Check Digit - enables Code 11 to check one digit.
- Two Check Digits - enables Code 11 to check 2 digits.



*Disable (0)



One Check Digit (1)



Two Check Digits (2)

Interleaved 2 of 5 (I 2 of 5)

Parameter # 6 (SSI #06h)

This parameter enables or disables I 2 of 5.

- *Enabled - enables I 2 of 5.
- Disabled - disables I 2 of 5.

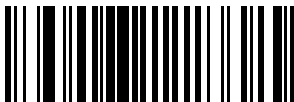

*Enable Interleaved 2 of 5 (1)

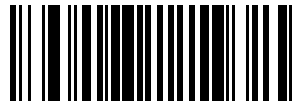

Disable Interleaved 2 of 5 (0)

Set Lengths for Interleaved 2 of 5 (I 2 of 5)

L1 Parameter # 22 (SSI #16h)

L2 Parameter # 23 (SSI #17h)

This parameter sets lengths for I 2 of 5.

The length of a code refers to the number of characters (for example, human-readable characters), including check digit(s) the code contains. Set lengths for I 2 of 5 to any length, one or two discrete lengths, or lengths within a specific range. The default is 6 to 55. The range for Interleaved 2 of 5 lengths is 0 - 80.



NOTE: When setting lengths, enter a leading zero for single digit numbers.

- One Discrete Length - Decode only I 2 of 5 symbols containing a selected length.
- Two Discrete Lengths - Decode only I 2 of 5 symbols containing either of two lengths.
- Length Within Range - Decode I 2 of 5 symbols with a specific length range.
- Any Length - Decode I 2 of 5 symbols containing any number of characters within the scanner's capability.



NOTE: Due to the construction of the I 2 of 5 symbology, it is possible for a scan line covering only a portion of the code to transmit as a complete scan, yielding less data than is encoded in the barcode. To prevent this, select specific lengths (I 2 of 5 - One Discrete Length, Two Discrete Lengths) for I 2 of 5 applications, or increase the [Security Level](#).

Select lengths using barcodes in [Numeric Barcodes](#). To correct an error or change the selection, scan [Cancel](#).

For example:

- To decode only I 2 of 5 symbols with 14 characters, scan I 2 of 5 - One Discrete Length, and then scan 1, 4.
- To decode only I 2 of 5 symbols containing either 2 or 14 characters, scan I 2 of 5 - Two Discrete Lengths, and then scan 0, 2, 1, 4.
- To decode I 2 of 5 symbols containing between 4 and 12 characters, scan I 2 of 5 - Length Within Range, and then scan 0, 4, 1, 2.



I 2 of 5 - One Discrete Length

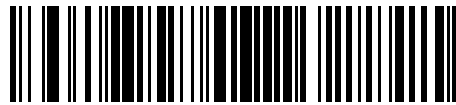

I 2 of 5 - Two Discrete Lengths

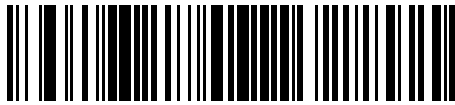

*I 2 of 5 - Length Within Range (Default: 6 to 55)

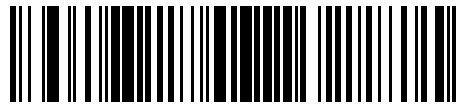

I 2 of 5 - Any Length

Interleaved 2 of 5 (I 2 of 5) Check Digit Verification

Parameter # 49 (SSI #31h)

This parameter enables or disables checking the integrity of all I 2 of 5 symbols to verify the data complies with either the specified Uniform Symbology Specification (USS) or the Optical Product Code Council (OPCC) check digit algorithm.

- *Disable - disables checking the integrity of all I 2 of 5 symbols to verify the data complies.
- USS Check Digit - enables checking the integrity of USS.
- OPCC Check Digit - enables checking the integrity of OPCC.

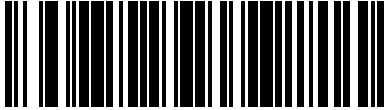

*Disable (0)

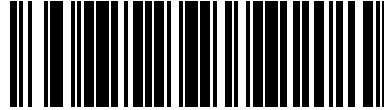

USS Check Digit (1)

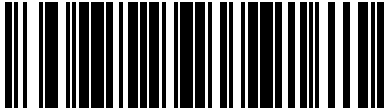

OPCC Check Digit (2)

Transmit I 2 of 5 Check Digit

Parameter # 44 (SSI #2Ch)

This parameter enables or disables transmission of I 2 of 5 data with or without the check digit.

- Enabled - enables transmission of check digit.
- *Disabled - disables transmission of check digit.

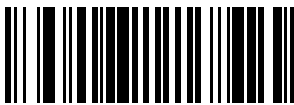

Transmit I 2 of 5 Check Digit (Enable) (1)

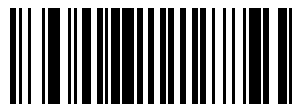

*Do Not Transmit I 2 of 5 Check Digit (Disable) (0)

Convert Interleaved 2 of 5 (I 2 of 5) to EAN-13

Parameter # 82 (SSI #52h)

This parameter enables or disables converting 14-character I 2 of 5 codes to EAN-13, and then transmitting to the host as EAN-13.

- Enabled - enables converting 14-character I 2 of 5 codes to EAN-13.
- *Disabled - disables converting 14-character I 2 of 5 codes to EAN-13.



NOTE: The I 2 of 5 code must be enabled, and the code must have a leading zero and a valid EAN-13 check digit.

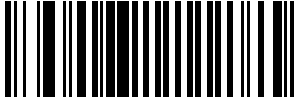

Convert I 2 of 5 to EAN-13 (Enable) (1)



*Do Not Convert I 2 of 5 to EAN-13 (Disable) (0)

Febraban

Parameter # 1750 (SSI #F8h 06h D6h)

This parameter enables or disables the I 2 of 5 internal check digit calculation and transmission.

Febraban is an Interleaved 2 of 5 (I 2 of 5) length 44 that requires inserting special check characters in the transmitted data stream.

- Enabled - enables internal check of digit calculation and transmission.
- *Disabled - disables internal check of digit calculation and transmission.



NOTE: Recommendations for length settings:

- I 2 of 5 Length 1: Larger of the fixed length and the Febraban length (==44).
- I 2 of 5 Length 2: Smaller of the fixed length and the Febraban length (==44).



Enable Febraban (1)



*Disable Febraban (0)

Interleaved 2 of 5 (I 2 of 5) Security Level

Parameter # 1121 (SSI #F8h 04h 61h)

This parameter sets the security level for I 2 of 5.

I 2 of 5 barcodes are vulnerable to misdecodes, particularly when I 2 of 5 Lengths is set to Any Length. The scanner offers four levels of decode security for I 2 of 5 barcodes. There is an inverse relationship between security and scanner aggressiveness. Increasing the level of security can reduce scanning aggressiveness, so select only the level of security necessary.

- I 2 of 5 Security Level 0: The scanner operates in its most aggressive state, while providing sufficient security in decoding most in-spec barcodes.
- I 2 of 5 Security Level 1: A barcode must be successfully read twice, and satisfy certain safety requirements before being decoded. This default setting eliminates most misdecodes.

- I 2 of 5 Security Level 2: This option applies greater barcode security requirements if Security Level 1 fails to eliminate misdecodes.
- I 2 of 5 Security Level 3: If you selected Security Level 2, and misdecodes still occur, select this security level. The highest safety requirements are applied. A barcode must be successfully read three times before being decoded.



NOTE: Selecting this option is an extreme measure against mis-decoding severely out-of-spec barcodes, and significantly impairs the decoding ability of the scanner. If this level of security is required, try to improve the quality of the barcodes.



I 2 of 5 Security Level 0 (0)

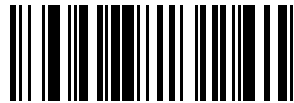

*I 2 of 5 Security Level 1 (1)

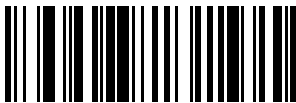

I 2 of 5 Security Level 2 (2)



I 2 of 5 Security Level 3 (3)

Interleaved 2 of 5 (I 2 of 5) Reduced Quiet Zone

Parameter # 1210 (SSI #F8h 04h B9h)

This parameter enables or disables decoding I 2 of 5 with reduced quiet zones (the margins on either side of the barcode).

If you select Enable, select a [1D Quiet Zone Level](#).

- Enabled - enables I 2 of 5 with reduced Quiet Zones.
- *Disabled - disables I 2 of 5 with reduced Quiet Zones.



Enable I 2 of 5 Reduced Quiet Zone (1)

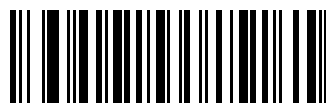

*Disable I 2 of 5 Reduced Quiet Zone (0)

Discrete 2 of 5 (D 2 of 5)

Parameter # 5 (SSI #05h)

This parameter enables or disables D 2 of 5.

- Enabled - enables D 2 of 5.
- *Disabled - disables D 2 of 5.

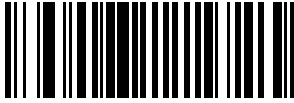

Enable Discrete 2 of 5 (1)

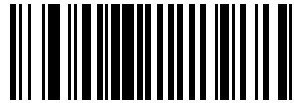

*Disable Discrete 2 of 5 (0)

Set Lengths for Discrete 2 of 5 (D 2 of 5)

L1 Parameter # 20 (SSI #14h)

L2 Parameter # 21 (SSI #15h)

This parameter sets lengths for D 2 of 5.

The length of a code refers to the number of characters (for example, human-readable characters), including check digit(s) the code contains. Set lengths for D 2 of 5 to any length, one or two discrete lengths, or lengths within a specific range. The default is 1 to 55.



NOTE: When setting lengths, enter a leading zero for single digit numbers.

Scan one of the following barcodes to select a length option:

- One Discrete Length - Decode only D 2 of 5 symbols containing a selected length.
- Two Discrete Lengths - Decode only D 2 of 5 symbols containing either of two lengths.
- Length Within Range - Decode D 2 of 5 symbols with a specific length range.
- Any Length - Decode D 2 of 5 symbols containing any number of characters within the scanner's capability.



NOTE: Due to the construction of the D 2 of 5 symbology, it is possible for a scan line covering only a portion of the code to transmit as a complete scan, yielding less data than is encoded in the barcode. To prevent this, select specific lengths (D 2 of 5 - One Discrete Length, Two Discrete Lengths) for D 2 of 5 applications.

Select lengths using barcodes in [Numeric Barcodes](#). To correct an error or change the selection, scan [Cancel](#).

For example:

- To decode only D 2 of 5 symbols with 14 characters, scan D 2 of 5 - One Discrete Length, and then scan 1, 4.

- To decode only D 2 of 5 symbols containing either 2 or 14 characters, scan D 2 of 5 - Two Discrete Lengths, and then scan 0, 2, 1, 4.
- To decode D 2 of 5 symbols containing between 4 and 12 characters, scan D 2 of 5 - Length Within Range, and then scan 0, 4, 1, 2.

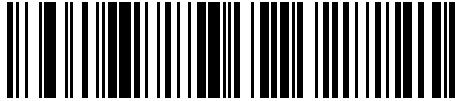

D 2 of 5 - One Discrete Length

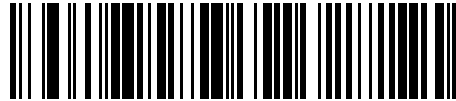

D 2 of 5 - Two Discrete Lengths

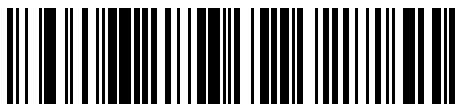

*D 2 of 5 - Length Within Range (Default: 1 to 55)

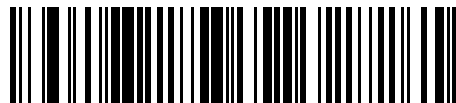

D 2 of 5 - Any Length

Codabar (NW - 7)

Parameter # 7 (SSI #07h)

This parameter enables or disables Codabar.

- *Enabled - enables Codabar.
- Disabled - disables Codabar.

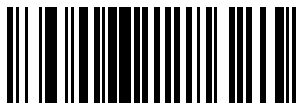

*Enable Codabar (1)

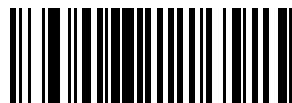

Disable Codabar (0)

Set Lengths for Codabar

L1 Parameter # 24 (SSI #18h)

L2 Parameter # 25 (SSI #19h)

This parameter sets lengths for Codabar.

The length of a code refers to the number of characters (for example, human-readable characters), including check digit(s) the code contains. Set lengths for Codabar to any length, one or two discrete lengths, or lengths within a specific range. The default is 4 to 55.



NOTE: When setting lengths, enter a leading zero for single-digit numbers.

- One Discrete Length - Decode only Codabar symbols containing a selected length.
- Two Discrete Lengths - Decode only Codabar symbols containing either of two lengths.
- Length Within Range - Decode Codabar symbols with a specific length range.
- Any Length - Decode Codabar symbols containing any number of characters within the scanner's capability.

Select lengths using barcodes in [Numeric Barcodes](#). To correct an error or change the selection, scan [Cancel](#).

For example:

- To decode only Codabar symbols with 14 characters, scan Codabar - One Discrete Length, and then scan 1, 4.
- To decode only Codabar symbols containing either 2 or 14 characters, scan Codabar - Two Discrete Lengths, and then scan 0, 2, 1, 4.
- To decode Codabar symbols containing between 4 and 12 characters, scan Codabar - Length Within Range, and then scan 0, 4, 1, 2.



Codabar - One Discrete Length

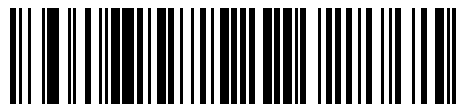

Codabar - Two Discrete Lengths



*Codabar - Length Within Range (Default: 4 to 55)

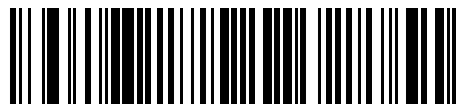

Codabar - Any Length

CLSI Editing

Parameter # 54 (SSI #36h)

This parameter enables or disables CLSI editing.

Select Enable CLSI Editing to strip the start and stop characters and insert a space after the first, fifth, and tenth characters of a 14-character Codabar symbol if the host system requires this data format.

- Enabled - enables CLSI editing.
- *Disabled - disables CLSI editing.



NOTE: Symbol length does not include start and stop characters.

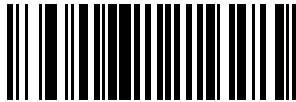

Enable CLSI Editing (1)

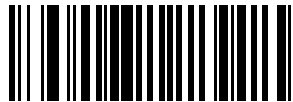

*Disable CLSI Editing (0)

NOTIS Editing

Parameter # 55 (SSI #37h)

This parameter enables or disables NOTIS editing which strips the start and stop characters from a decoded Codabar symbol if the host system requires this data format.

- Enabled - enables NOTIS editing.
- *Disabled - disables NOTIS editing.

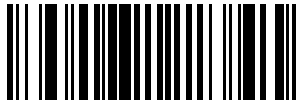

Enable NOTIS Editing (1)

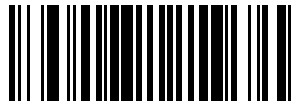

*Disable NOTIS Editing (0)

Codabar Security Level

Parameter # 1776 (SSI #F8h 06h F0h)

This parameter sets the security level for Codabar 39.

The scanner offers four levels of decode security for Codabar barcodes. There is an inverse relationship between security and scanner aggressiveness. Increasing the level of security can reduce scanning aggressiveness, so select only the level of security necessary.

- Codabar Security Level 0: This setting allows the scanner to operate in its most aggressive state, while providing sufficient security in decoding most in-spec barcodes.

- Codabar Security Level 1: This default setting eliminates most misdecodes.
- Codabar Security Level 2: Select this option with greater barcode security requirements if Security Level 1 fails to eliminate misdecodes.
- Codabar Security Level 3: If you selected Security Level 2, and misdecodes still occur, select this security level to apply the highest safety requirements.



NOTE: Selecting this option is an extreme measure against mis-decoding severely out-of-spec barcodes, and significantly impairs the decoding ability of the scanner. If this level of security is required, try to improve the quality of the barcodes.

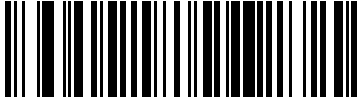

Codabar Security Level 0 (0)

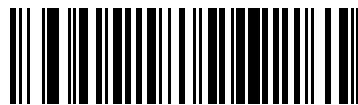

*Codabar Security Level 1 (1)

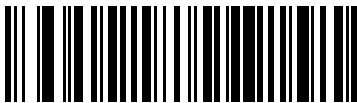

Codabar Security Level 2 (2)



Codabar Security Level 3 (3)

Codabar Upper or Lower Case Start/Stop Characters

Parameter # 855 (SSI #F2h 57h)

This parameter selects whether to transmit upper case or lower case Codabar start/stop characters.

- Lower Case (1) - enables lowercase start/stop characters.
- *Upper Case (0) - enables upper case start/stop characters.



Lower Case (1)

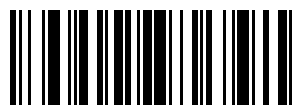

*Upper Case (0)

MSI

Parameter # 11 (SSI #0Bh)

This parameter enables or disables MSI.

- Enabled - enables MSI.
- *Disabled - disables MSI.



Enable MSI (1)

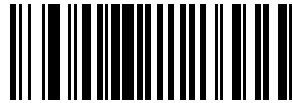

*Disable MSI (0)

Set Lengths for MSI

L1 Parameter # 30 (SSI #1Eh)

L2 Parameter # 31 (SSI #1Fh)

This parameter sets lengths for MSI.

The length of a code refers to the number of characters (for example, human-readable characters), including check digit(s) the code contains. Set lengths for MSI to any length, one or two discrete lengths, or lengths within a specific range. The default is 4 to 55.



NOTE: When setting lengths, enter a leading zero for single-digit numbers.

Scan one of the following barcodes to select a length option:

- One Discrete Length - Decode only MSI symbols containing a selected length.
- Two Discrete Lengths - Decode only MSI symbols containing either of two lengths.
- Length Within Range - Decode MSI symbols with a specific length range.
- Any Length - Decode MSI symbols containing any number of characters within the scanner's capability.



NOTE: Due to the construction of the MSI symbology, it is possible for a scan line covering only a portion of the code to transmit as a complete scan, yielding less data than is encoded in the barcode. To prevent this, select specific lengths (MSI - One Discrete Length, Two Discrete Lengths) for MSI applications.

Select lengths using barcodes in [Numeric Barcodes](#). To correct an error or change the selection, scan [Cancel](#).

For example:

- To decode only MSI symbols with 14 characters, scan MSI - One Discrete Length, and then scan 1, 4.
- To decode only MSI symbols containing either 2 or 14 characters, scan MSI - Two Discrete Lengths, and then scan 0, 2, 1, 4.

- To decode MSI symbols containing between 4 and 12 characters, scan MSI - Length Within Range, and then scan 0, 4, 1, 2.

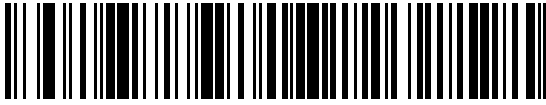

MSI - One Discrete Length

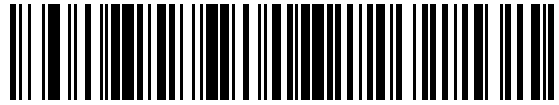

MSI - Two Discrete Lengths

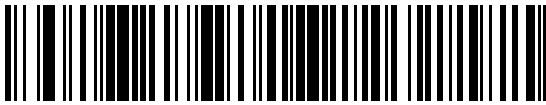

*MSI - Length Within Range (Default: 4 to 55)

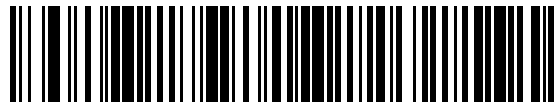

MSI - Any Length

MSI Check Digits

Parameter # 50 (SSI #32h)

This parameter checks the MSI check digit to verify that the data complies with the specified check digit algorithm.

With MSI symbols, one check digit is mandatory and always verified by the reader. The second check digit is optional. If the MSI codes include two check digits, select the Two MSI Check Digits option to enable verification of the second check digit.

- 0 - Does not check the MSI check digit; decodes MSI with no check digit.
- 1 - This is for MSI barcodes with one check digit. This is the default.
- 2 - This is for MSI barcodes with two check digits.

See [MSI Check Digit Algorithm](#) to select second digit algorithms.



No MSI Check Digit (0)



*One MSI Check Digits (1)



Two MSI Check Digit (2)

Transmit MSI Check Digit(s)

Parameter # 46 (SSI #2Eh)

This parameter transmits MSI data with or without the check digit.

- Enabled - transmits MSI data with check digit.
- *Disabled - does not transmit MSI data check digit.

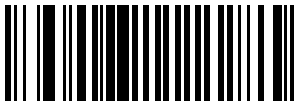

Transmit MSI Check Digit(s) (Enable) (1)

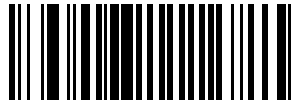

*Do Not Transmit MSI Check Digit(s) (Disable) (0)

MSI Check Digit Algorithm

Parameter # 51 (SSI #33h)

This parameter selects the algorithm used to encode the check digit.

Two algorithms are available for verifying the second MSI check digit. Select one of the following options to select the algorithm used to encode the check digit.

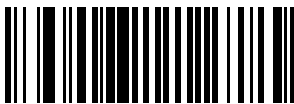

MOD 11/MOD 10 (0)



*MOD 10/MOD 10 (1)

MSI Reduced Quiet Zone

Parameter # 1392 (SSI #F8h 05h 70h)

This parameter enables or disables decoding MSI with reduced quiet zones (the margins on either side of the barcode).

If you select Enable, select a [1D Quiet Zone Level](#).

- *Disabled - disables MSI with reduced Quiet Zones.
- Enabled - enables MSI with reduced Quiet Zones.



*Disable MSI Reduced Quiet Zone (0)

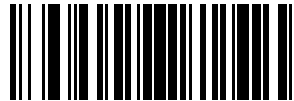

Enable MSI Reduced Quiet Zone (1)

Chinese 2 of 5

Parameter # 408 (SSI #98h)

This parameter enables or disables Chinese 2 of 5.

- Enabled - enables Chinese 2 of 5.
- *Disabled - disables Chinese 2 of 5.

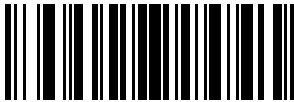

Enable Chinese 2 of 5 (1)

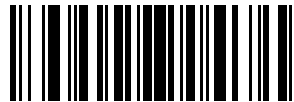

*Disable Chinese 2 of 5 (0)

Matrix 2 of 5

Parameter # 618 (SSI #F1h 6Ah)

This parameter enables or disables Matrix 2 of 5.

- Enabled - enables Matrix 2 of 5.
- *Disabled - disables Matrix 2 of 5.



Enable Matrix 2 of 5 (1)

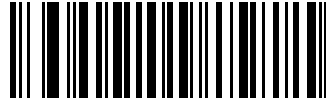

*Disable Matrix 2 of 5 (0)

Set Lengths for Matrix 2 of 5

L1 Parameter # 619 (SSI #F1h 6Bh)

L2 Parameter # 620 (SSI #F1h 6Ch)

This parameter set lengths for Matrix 2 of 5.

The length of a code refers to the number of characters (for example, human-readable characters), including check digit(s) the code contains. Set lengths for Matrix 2 of 5 to any length, one or two discrete lengths, or lengths within a specific range. The default is 4 to 55.



NOTE: When setting lengths, enter a leading zero for single-digit numbers.

Scan one of the following barcodes to select a length option:

- One Discrete Length - Decode only Matrix 2 of 5 symbols containing a selected length.
- Two Discrete Lengths - Decode only Matrix 2 of 5 symbols containing either of two lengths.
- Length Within Range - Decode Matrix 2 of 5 symbols with a specific length range.
- Any Length - Decode Matrix 2 of 5 symbols containing any number of characters within the scanner's capability.

Select lengths using barcodes in [Numeric Barcodes](#). To correct an error or change the selection, scan [Cancel](#).

For example:

- To decode only Matrix 2 of 5 symbols with 14 characters, scan Matrix 2 of 5 - One Discrete Length, and then scan 1, 4.
- To decode only Matrix 2 of 5 symbols containing either 2 or 14 characters, scan Matrix 2 of 5 - Two Discrete Lengths, and then scan 0, 2, 1, 4.
- To decode Matrix 2 of 5 symbols containing between 4 and 12 characters, scan Matrix 2 of 5 - Length Within Range, and then scan 0, 4, 1, 2.



Matrix 2 of 5 - One Discrete Length



Matrix 2 of 5 - Two Discrete Lengths



*Matrix 2 of 5 - Length Within Range (Default:4 to 55)

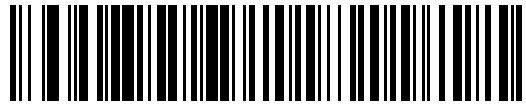

Matrix 2 of 5 - Any Length

Matrix 2 of 5 Check Digit

Parameter # 622 (SSI #F1h 6Eh)

This parameter determines whether to include the Matrix 2 of 5 check digit with the barcode data. The check digit is the last character of the symbol used to verify the integrity of the data.

- Enabled - enables Matrix 2 of 5 Check Digit.
- *Disabled - disables Matrix 2 of 5 Check Digit.



Enable Matrix 2 of 5 Check Digit (1)



*Disable Matrix 2 of 5 Check Digit (0)

Transmit Matrix 2 of 5 Check Digit

Parameter # 623 (SSI #F1h 6Fh)

This parameter transmits Matrix 2 of 5 data with or without the check digit.

- Transmit - enables Transmit Matrix 2 of 5 Check Digit.
- *Do Not Transmit - does not Transmit Matrix 2 of 5 Check Digit.

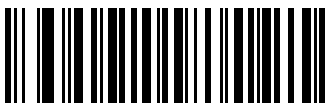

Transmit Matrix 2 of 5 Check Digit (1)



*Do Not Transmit Matrix 2 of 5 Check Digit (0)

Korean 3 of 5

Parameter # 581 (SSI #F1h 45h)

This parameter enables or disables Korean 3 of 5.

- Enabled - enables Korean 3 of 5.
- *Disabled - disables Korean 3 of 5.



NOTE: The length for Korean 3 of 5 is fixed at 6.

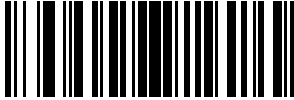

Enable Korean 3 of 5 (1)

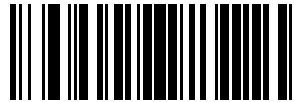

*Disable Korean 3 of 5 (0)

Inverse 1D

Parameter # 586 (SSI #F1h 4Ah)

This parameter sets the 1D inverse decoder setting.

- Regular Only - The scanner decodes regular 1D barcodes only.
- Inverse Only - The scanner decodes inverse 1D barcodes only.
- Inverse Autodetect - The scanner decodes both regular and inverse 1D barcodes.



NOTE: This parameter does not apply to GS1 DataBarcode types.



NOTE: The Inverse 1D setting may impact Composite or Inverse Composite decoding.



*Regular Only (0)



Inverse Only (1)



Inverse Autodetect (2)

GS1 DataBar

The variants of GS1 DataBar are DataBar Omnidirectional, DataBar Limited, and DataBar Expanded. The limited and expanded versions have stacked variants. Choose to enable or disable each variant of the GS1 DataBar.

GS1 DataBar Omnidirectional (formerly GS1 DataBar-14)

Parameter # 338 (SSI #F0h 52h)

This parameter enables or disables GS1 DataBar Omnidirectional.

- *Enabled - enables GS1 DataBar Omnidirectional.
- Disabled - disables GS1 DataBar Omnidirectional.

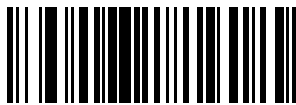

*Enable GS1 DataBar Omnidirectional (1)

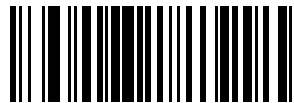

Disable GS1 DataBar Omnidirectional (0)

GS1 DataBar Limited

Parameter # 339 (SSI #F0h 53h)

This parameter enables or disables GS1 DataBar Limited.

- *Enabled - enables GS1 DataBar Limited.
- Disabled - disables GS1 DataBar Limited.

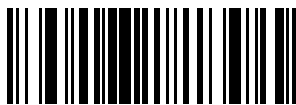

*Enable GS1 DataBar Limited (1)

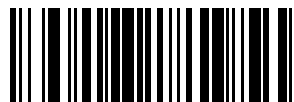

Disable GS1 DataBar Limited (0)

GS1 DataBar Expanded

Parameter # 340 (SSI #F0h 54h)

This parameter enables or disables GS1 DataBar Expanded.

- *Enabled - enables GS1 DataBar Expanded.

- Disabled - disables GS1 DataBar Expanded.

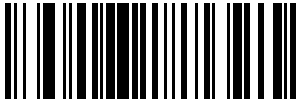

*Enable GS1 DataBar Expanded (1)

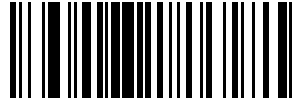

Disable GS1 DataBar Expanded (0)

Convert GS1 DataBar to UPC/EAN/JAN

Parameter # 397 (SSI #F0h, 8Dh)

This parameter enables or disables Convert GS1 DataBar to UPC/EAN/JAN.

- Enabled - enables Convert GS1 DataBar to UPC/EAN/JAN.
- *Disabled - disables Convert GS1 DataBar to UPC/EAN/JAN.

This parameter only applies to GS1 DataBar Omnidirectional and GS1 DataBar Limited symbols not decoded as part of a Composite symbol. Enable Convert GS1 DataBar to UPC/EAN/JAN strips the leading '010' from DataBar Omnidirectional and DataBar Limited symbols encoding a single zero as the first digit, and then reports as EAN-13.

For barcodes beginning with between two and five zeros, this strips the leading '0100' and reports the barcode as UPC-A. The [UPC-A Preamble](#) option that transmits the system character and country code applies to converted barcodes. Note that neither the system character nor the check digit can be stripped.

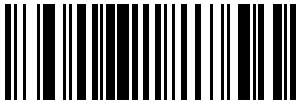

Enable Convert GS1 DataBar to UPC/EAN/JAN (1)

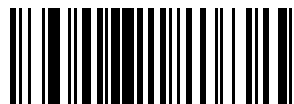

*Disable Convert GS1 DataBar to UPC/EAN/JAN (0)

GS1 DataBar Security Level

Parameter # 1706 (SSI #F8h 06h AAh)

This parameter sets the security level for GS1 DataBar.

The scanner offers four levels of decode security for GS1 DataBar (GS1 DataBar Omnidirectional, GS1 DataBar Limited, GS1 DataBar Expanded) barcodes.

- Security Level 0 - The scanner operates in its most aggressive state, while providing sufficient security decoding most in-spec barcodes.
- *Security Level 1 - This setting eliminates most misdecodes while maintaining reasonable aggressiveness.

- Security Level 2 - Select this option with greater barcode security requirements if Security Level 1 fails to eliminate misdecodes.
- Security Level 3 - If you selected Security Level 2 and misdecodes still occur, select this security level to apply the highest safety requirements.



GS1 DataBar Security Level 0 (0)



*GS1 DataBar Security Level 1 (1)



GS1 DataBar Security Level 2 (2)



GS1 DataBar Security Level 3 (3)

GS1 DataBar Limited Margin Check

Parameter # 728 (SSI #F1h D8h)

This parameter sets the margin level for GS1 DataBar.

The scanner offers four levels of decode security for GS1 DataBar Limited barcodes. There is an inverse relationship between the level of margin check and scanner aggressiveness. Increasing the level of margin check can reduce scanning aggressiveness, so select only the level of margin check necessary.

- Margin Check Level 1 – No clear margin required. This complies with the original GS1 standard, yet can result in erroneous decoding of a DataBar Limited barcode when scanning some UPC symbols that start with digits 9 and 7.
- Margin Check Level 2 – Automatic risk detection. This level of margin check can result in erroneous decoding of DataBar Limited barcodes when scanning some UPC symbols. If a misdecode is detected, the scanner operates in Level 3 or Level 1.
- *Margin Check Level 3 – Margin check level reflects the newly proposed GS1 standard that requires a five times trailing clear margin.
- Margin Check Level 4 – Margin check level extends beyond the standard required by GS1. This level of margin check requires a five times leading and trailing clear margin.



GS1 DataBar Limited Margin Check Level 1 (1)

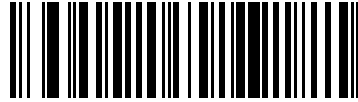

GS1 DataBar Limited Margin Check Level 2 (2)



*GS1 DataBar Limited Margin Check Level 3 (3)

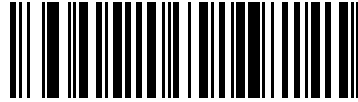

GS1 DataBar Limited Margin Check Level 4 (4)

GS1 DataBar Expanded Security Level

Parameter # 1707 (SSI #F8h 06h ABh)

This parameter set the expanded security level for GS1 DataBar.

The scanner offers four levels of decode security for GS1 DataBar Expanded:

- Security Level 0 - The scanner operates in its most aggressive state, while providing sufficient security decoding most in-spec barcodes.
- *Security Level 1 - This setting eliminates most misdecodes while maintaining reasonable aggressiveness.
- Security Level 2 - Select this option with greater barcode security requirements if Security Level 1 fails to eliminate misdecodes.
- Security Level 3 - If you selected Security Level 2 and misdecodes still occur, select this security level to apply the highest safety requirements.



GS1 DataBar Expanded Security Level 0 (0)



*GS1 DataBar Expanded Security Level 1 (1)



GS1 DataBar Expanded Security Level 2 (2)



GS1 DataBar Expanded Security Level 3 (3)

Symbology-Specific Security Features

These security features are unique to the Symbology section.

Redundancy Level

Parameter # 78 (SSI #4Eh)

This parameter selects the redundancy level appropriate for the barcode quality.

Select higher redundancy levels for decreasing levels of barcode quality. As redundancy levels increase, the scanner's aggressiveness decreases.

- *Redundancy Level 1 - The scanner must read the following code types twice before decoding:
 - Codabar (8 characters or less)
 - MSI (4 characters or less)
 - D 2 of 5 (8 characters or less)
 - I 2 of 5 (8 characters or less)
- Redundancy Level 2 - The scanner must read all code types twice before decoding.
- Redundancy Level 3 - The scanner must read code types other than the following twice before decoding, but must read the following codes three times:
 - Codabar (8 characters or less)
 - MSI (4 characters or less)
 - D 2 of 5 (8 characters or less)
 - I 2 of 5 (8 characters or less)
- Redundancy Level 4 - The scanner must read all code types three times before decoding.

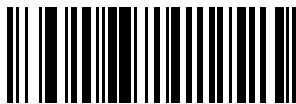

*Redundancy Level 1 (1)



Redundancy Level 2 (2)

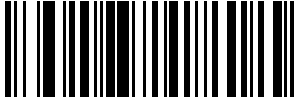

Redundancy Level 3 (3)



Redundancy Level 4 (4)

Security Level

Parameter # 77 (SSI #4Dh)

This parameter sets the security level.

The scanner offers four levels of decode security, which include the Code 128 family, UPC/EAN/JAN, and Code 93. Select increasing levels of security for decreasing levels of scanning quality. There is an inverse relationship between security and scanner aggressiveness, so choose only that level of security necessary for the application.

- Security Level 0 - The scanner operates in its most aggressive state, while providing sufficient security decoding most in-spec barcodes.
- Security Level 1 - This default setting eliminates most mis-decodes.
- Security Level 2 - Select this option if Security Level 1 fails to eliminate mis-decodes.
- Security Level 3 - If you selected Security Level 2 and mis-decodes still occur, select this security level.



NOTE: Selecting this option is an extreme measure against mis-decoding severely out-of-spec barcodes, and significantly impairs the decoding ability of the scanner. If this level of security is required, try to improve the quality of the barcodes.

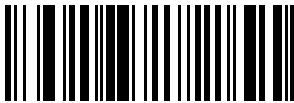

Security Level 0 (0)

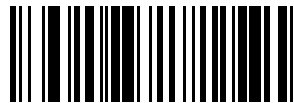

*Security Level 1 (1)



Security Level 2 (2)

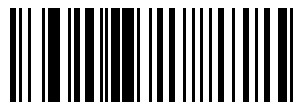

Security Level 3 (3)

1D Quiet Zone Level

Parameter # 1288 (SSI #F8h 05h 08h)

This parameter sets the level of aggressiveness when setting a reduced quiet zone (the margin on either side of a barcode), and applies to symbologies enabled by a Reduced Quiet Zone parameter.

Because higher levels increase the decoding time and risk of mis-decodes, Zebra strongly recommends enabling only the symbologies which require higher quiet zone levels, and leaving Reduced Quiet Zone disabled for all other symbologies. Options are:

- 1D Quiet Zone Level 0 - The scanner performs normally in terms of quiet zone.
- *1D Quiet Zone Level 1 - The scanner performs more aggressively in terms of quiet zone.
- 1D Quiet Zone Level 2 - The scanner only requires a quiet zone at the end of barcode for decoding.
- 1D Quiet Zone Level 3 - The scanner decodes anything in terms of quiet zone or end of barcode.

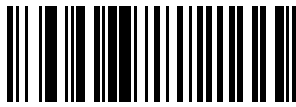

1D Quiet Zone Level 0 (0)



*1D Quiet Zone Level 1 (1)

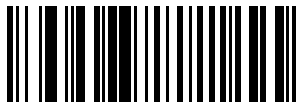

1D Quiet Zone Level 2 (2)



1D Quiet Zone Level 3 (3)

Intercharacter Gap Size

Parameter # 381 (SSI #F0h 7Dh)

This parameter enables a device to tolerate large intercharacter gap sizes.

The Code 39 and Codabar symbologies have an intercharacter gap that is typically quite small. Due to various barcode printing technologies, this gap can grow larger than the maximum size allowed, preventing the scanner from decoding the symbol. If this problem occurs, scan the Large Intercharacter Gaps parameter to tolerate these out-of-specification barcodes.



*Normal Intercharacter Gaps (6)



Large Intercharacter Gaps (10)

Composite

Composites link symbols or barcodes together and they are read by a scanner as one object.

Composite CC-C

Parameter # 341 (SSI #F0h 55h)

This parameter enables or disables Composite barcodes of type CC-C.

- Enabled - enables CC-C.
- *Disabled - disables CC-C.

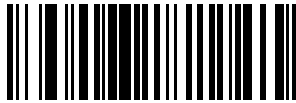

Enable CC-C (1)

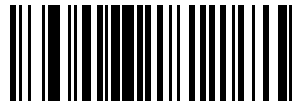

*Disable CC-C (0)

Composite CC-A/B

Parameter # 342 (SSI #F0h 56h)

This parameter enables or disables CC-A/B.

- Enabled - enables CC-A/B.
- *Disabled - disables CC-A/B.

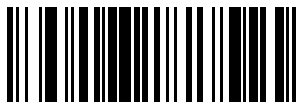

Enable CC-A/B (1)

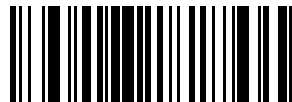

*Disable CC-A/B (0)

Composite TLC-39

Parameter # 371 (SSI #F0h 73h)

This parameter enables or disables TLC-39.

- Enabled - enables TLC-39.
- *Disabled - disables TLC-39.



Enable TLC39 (1)

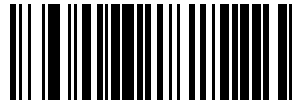

*Disable TLC39 (0)

Composite Inverse

Parameter # 1113 (SSI #F8h 04h 59h)

This parameter sets Composite for either regular decode or inverse decode.

- *Regular Only - The scanner decodes regular Composite barcodes only. Before selecting this, set [Inverse 1D](#) to Regular Only or Inverse Autodetect.
- Inverse Only - The scanner decodes inverse Composite barcodes only. This mode only supports Composite Inverse that includes DataBar combined with CCAB, and does not support other 1D/2D combinations. Before selecting this, first enable [Composite CC-A/B](#), and set [Inverse 1D](#) to Inverse Only or Inverse Autodetect.

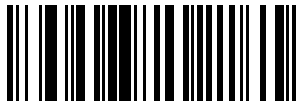

*Regular Only (0)

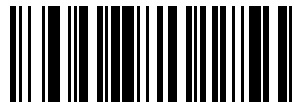

Inverse Only (1)

UPC Composite Mode

Parameter # 344 (SSI #F0h 58h)

This parameter links UPC symbols with a 2D symbol during transmission as if they were one symbol.

- *UPC Never Linked - Transmit UPC barcodes regardless of whether a 2D symbol is detected.
- UPC Always Linked - Transmit UPC barcodes and the 2D portion. If 2D is not present, do not transmit the barcode.

- Autodiscriminate UPC Composites - The scanner determines if there is a 2D portion, then transmits the UPC, as well as the 2D portion if present.

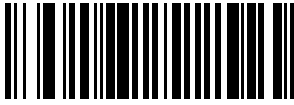

*UPC Never Linked (0)



UPC Always Linked (1)



Autodiscriminate UPC Composites (2)

Composite Beep Mode

Parameter # 398 (SSI #F0h 8Eh)

This parameter selects the number of decode beeps that sound upon decoding a Composite.

- Single Beep - after both are decoded.
- *Beep for each code type - as each code type is decoded.
- Double Beep - after both are decoded.

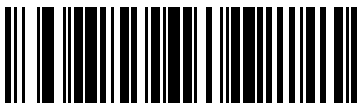

Single Beep After Both are Decoded (0)



*Beep as Each Code Type is Decoded (1)

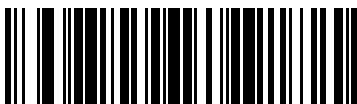

Double Beep After Both are Decoded (2)

GS1-128 Emulation Mode for UCC/EAN Composite Codes

Parameter # 427 (SSI #F0h ABh)

This parameter enables or disables GS1-128 Emulation Mode for UCC/EAN Composite Codes.

- Enabled - enables GS1-128 Emulation Mode for UCC/EAN Composite Codes.
- *Disabled - disables GS1-128 Emulation Mode for UCC/EAN Composite Codes.



Enable GS1-128 Emulation Mode for UCC/EAN Composite Codes (1)

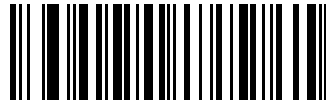

*Disable GS1-128 Emulation Mode for UCC/EAN Composite Codes (0)

2D Symbologies

The following parameters are specific to 2D Symbologies.

PDF417

Parameter # 15 (SSI 0Fh)

This parameter enables or disables PDF417.

- *Enabled - enables PDF417.
- Disabled - disables PDF417.

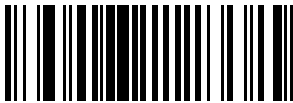

*Enable PDF417 (1)

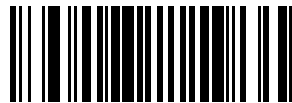

Disable PDF417 (0)

MicroPDF417

Parameter # 227 (SSI #E3h)

This parameter enables or disables MicroPDF417

- Enabled - enables MicroPDF417.
- *Disabled - disables MicroPDF417.



Enable MicroPDF417 (1)

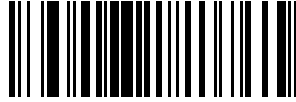

*Disable MicroPDF417 (0)

Code 128 Emulation

Parameter # 123 (SSI #7Bh)

This parameter transmits data from certain MicroPDF417 symbols as Code 128.

You must enable [AIM Code Characters](#) for this parameter to work.

Enable Code 128 Emulation to transmit these MicroPDF417 symbols with one of the following prefixes:

]C1 if the first codeword is 903–905

]C2 if the first codeword is 908 or 909

]C0 if the first codeword is 910 or 911

Disable Code 128 Emulation to transmit these MicroPDF417 symbols with one of the following prefixes:

]L3 if the first codeword is 903–905

]L4 if the first codeword is 908 or 909

]L5 if the first codeword is 910 or 911



NOTE: Linked MicroPDF codewords 906, 907, 912, 914, and 915 are not supported. Use GS1 Composites instead.



Enable Code 128 Emulation (1)

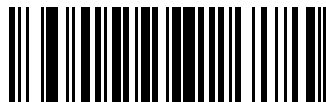

*Disable Code 128 Emulation (0)

Data Matrix

Parameter # 292 (SSI #F0h 24h)

This parameter enables or disables Data Matrix.

- *Enabled - enables Data Matrix.
- Disabled - disables Data Matrix.

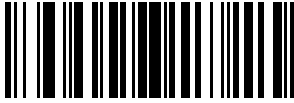

*Enable Data Matrix (1)



Disable Data Matrix (0)

GS1 Data Matrix

Parameter # 1336 (SSI #F8h 05h 38h)

This parameter enables or disables GS1 Data Matrix.

- Enabled - enables GS1 Data Matrix.
- *Disabled - disables GS1 Data Matrix.

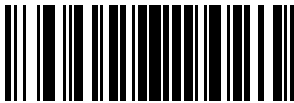

Enable GS1 Data Matrix (1)

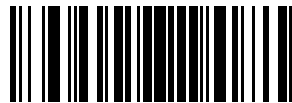

*Disable GS1 Data Matrix (0)

Data Matrix Inverse

Parameter # 588 (SSI #F1h 4Ch)

This parameter selects the Data Matrix inverse decoder setting.

- Regular Only - The scanner decodes regular Data Matrix barcodes only.
- Inverse Only - The scanner decodes inverse Data Matrix barcodes only.
- *Inverse Autodetect - The scanner decodes both regular and inverse Data Matrix barcodes.



Regular Only (0)



Inverse Only (1)



*Inverse Autodetect (2)

Decode Data Matrix Mirror Images

Parameter # 537 (SSI #F1h 19h)

This parameter selects an option for decoding Data Matrix mirror images.

- Never - Do not decode Data Matrix barcodes that are mirror images.
- Always - Decode only Data Matrix barcodes that are mirror images.
- *Auto - Decode both mirrored and unmirrored Data Matrix barcodes.

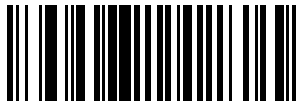

Never (0)

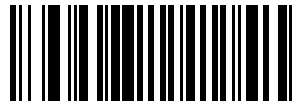

Always (1)

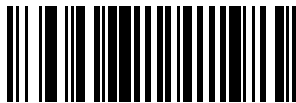

*Auto (2)

Maxicode

Parameter # 294 (SSI #F0h 26h)

This parameter enables or disables Maxicode.

- Enabled - enables Maxicode.
- *Disabled - disables Maxicode.



Enable Maxicode (1)



*Disable Maxicode (0)

QR Code

Parameter # 293 (SSI #F0h 25h)

This parameter enables or disables QR Code.

- *Enabled - enables QR Code.
- Disabled - disables QR Code.



NOTE: Enabling this also enables QR Mirrored and Linked QR.



*Enable QR Code (1)

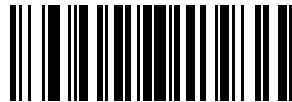

Disable QR Code (0)

Weblink QR

Parameter # 1947 (SSI #F8 07 9Bh)

This parameter enables you to decode or not decode Weblink QR codes.

- Do Not Decode Weblink QR Codes - disables you from decoding Weblink QR codes.
- Decode Weblink QR Codes - enables you to decode Weblink QR codes.

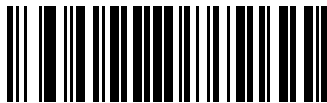

Disable Weblink QR (0)

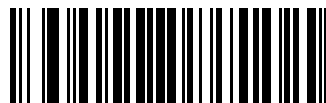

*Enable Weblink QR (1)

GS1 QR

Parameter # 1343 (SSI #F8h 05h 3Fh)

This parameter enables or disables GS1 QR.

- *Enabled - enables GS1 QR
- Disabled - disables GS1 QR.

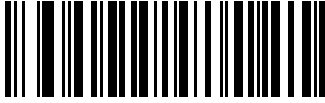

*Enable GS1 QR (1)



Disable GS1 QR (0)

MicroQR

Parameter # 573 (SSI #F1h 3Dh)

This parameter enables or disables MicroQR.

- *Enabled - enables MicroQR.
- Disabled - disables MicroQ.

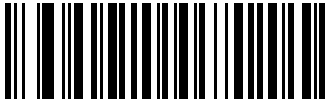

*Enable MicroQR (1)

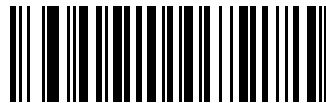

Disable MicroQR (0)

Linked QR Mode

Parameter # 1847 (SSI #737h)

This parameter selects a linked QR mode.

- *Linked QR Only - The scanner does not decode individual QR symbols from a set of linked QR codes.
- Individual QR With Headers - The scanner decodes individual QR symbols from a set of linked QR codes and retains the header information and data.
- Individual QR No Headers - The scanner decodes individual QR symbols from a set of linked QR codes and transmits the data without header information.



*Linked QR Only (0)

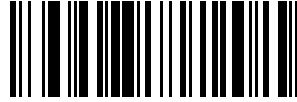

Individual QR With Headers (1)



Individual QR No Headers (2)

Aztec

Parameter # 574 (SSI #F1h 3Eh)

This parameter enables or disables Aztec.

- *Enabled - enables Aztec.
- Disabled - disables Aztec.



NOTE: Enabling this also enables Linked Aztec.

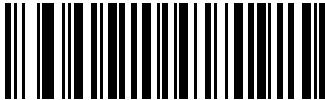

*Enable Aztec (1)

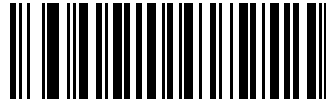

Disable Aztec (0)

Aztec Inverse

Parameter # 589 (SSI #F1h 4Dh)

This parameter selects the Aztec inverse decoder setting.

- Regular Only - The scanner decodes regular Aztec barcodes only.
- Inverse Only - The scanner decodes inverse Aztec barcodes only.
- *Inverse Autodetect - The scanner decodes both regular and inverse Aztec barcodes.



Regular Only (0)



Inverse Only (1)



*Inverse Autodetect (2)

Han Xin

Parameter # 1167 (SSI #F8h 04h 8Fh)

This parameter enables or disables Han Xin.

- Enabled - enables Han Xin.
- *Disabled - disables Han Xin.

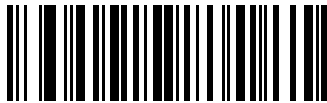

Enable Han Xin (1)

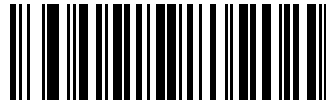

*Disable Han Xin (0)

Han Xin Inverse

Parameter # 1168 (SSI #F8h 04h 90h)

This parameter selects a Han Xin inverse decoder setting.

- *Regular Only - The scanner decodes Han Xin barcodes with normal reflectance only.
- Inverse Only - The scanner decodes Han Xin barcodes with inverse reflectance only.
- Inverse Autodetect - The scanner decodes both regular and inverse Han Xin barcodes.



*Regular Only (0)



Inverse Only (1)

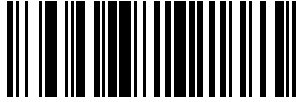

Inverse Autodetect (2)

Grid Matrix

Parameter # 1718 (SSI #F8 06h B6h)

This parameter enables or disables Grid Matrix.

- Enabled - enables Grid Matrix.
- *Disabled - disables Grid Matrix.

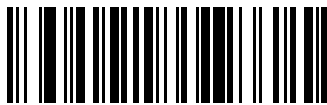

Enable Grid Matrix (1)

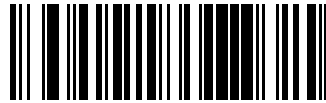

*Disable Grid Matrix (0)

Grid Matrix Inverse

Parameter # 1719 (SSI #F8h 06h B7h)

This parameter selects a Grid Matrix inverse decoder setting.

- *Regular Only - the imager decodes Grid Matrix barcodes with normal reflectance only.
- Inverse Only - the imager decodes Grid Matrix barcodes with inverse reflectance only.
- Inverse Autodetect - the imager decodes both regular and inverse Grid Matrix barcodes.



*Regular (0)



Inverse Only (1)

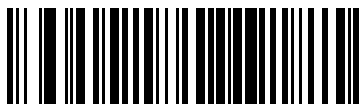

Inverse Autodetect (2)

Grid Matrix Mirrored

Parameter # 1736 (SSI #F8h 06h C8h)

This parameter selects a mirror image Grid Matrix setting.

- *Non-Mirrored Only - the imager decodes non-mirrored Grid Matrix barcodes only.
- Mirrored Only - the imager decodes mirrored Grid Matrix barcodes only.
- Autodetect - the imager decodes both mirrored and non-mirrored Grid Matrix barcodes.

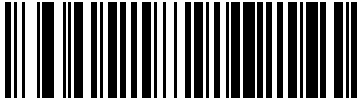

*Non-Mirrored Only (0)

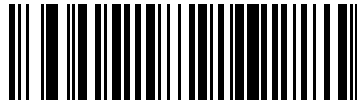

Mirrored Only (1)

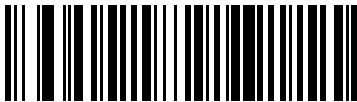

Mirrored Autodetect (2)

DotCode

Parameter # 1906 (SSI #F8 07 72h)

You can enable or disable DotCode.

- Enabled - enables DotCode.
- *Disabled - disables DotCode.

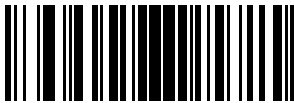

*Disable DotCode (0)

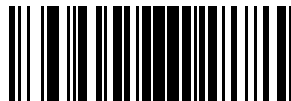

Enable Dotcode (1)

DotCode Prioritize

Parameter # 1937 (SSI #F8 07 91h)

This parameter enables or disables giving priority to DotCode decoding versus other symbologies.

- Disabled - disables DotCode as a priority.

- *Enabled - enables DotCode as a priority.

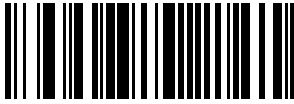

Disable DotCode Prioritize (0)

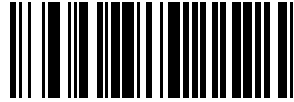

*Enable DotCode Prioritize (1)

DotCode Inverse

Parameter # 1907 (SSI #F8 07 73h)

This parameter selects the DotCode Inverse decoder setting.

- Regular Only - the device decodes DotCode Inverse codes with normal reflectance only.
- Inverse Only - the device decodes DotCode Inverse codes with inverse reflectance only.
- Inverse Autodetect - the device decodes DotCode Inverse codes with both normal and inverse reflectance.

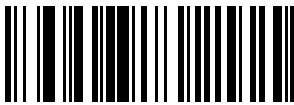

Regular (0)



Inverse Only (1)

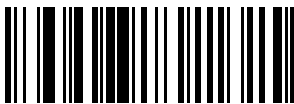

*Autodetect (2)

DotCode Mirrored

Parameter # 1908 (SSI #F8 07 74h)

This parameter sets a DotCode Mirror decoder setting.

- Never - decodes non-mirrored DotCode codes only.
- Always - decodes mirrored DotCode codes only.
- *Autodetect - decodes both mirrored and non-mirrored DotCode codes.



Never (0)



Always (1)



*Autodetect

Macro PDF Features

Macro PDF is a special feature for combining multiple PDF symbols into one file. The scanner can decode symbols encoded with this feature, and can store more than 64 Kb of decoded data from up to 50 MacroPDF symbols.

When printing, keep each Macro PDF sequence separate, as each sequence has unique identifiers. Do not mix barcodes from several Macro PDF sequences, even if they encode the same data. When scanning a Macro PDF sequence, scan the entire sequence without interruption. When scanning a mixed sequence, two long low beeps (low/low) indicate an inconsistent file ID or inconsistent symbology error.

Escape Characters

Parameter # 233 (SSI #E9h)

This parameter enables the backslash (\) character as an Escape character for systems that can process transmissions containing special data sequences.

You can either format special data according to the GLI (Global Label Identifier) protocol, or disable this parameter. This parameter only affects the data portion of a Macro PDF symbol transmission; the Macro PDF Control Header (if enabled) is always sent with GLI formatting.



GLI Protocol (2)



*None (0)

Flush Macro PDF Buffer

This parameter flushes the buffer of all decoded Macro PDF data stored to that point, transmits it to the host device, and aborts from Macro PDF mode.



Flush Macro PDF Buffer

Abort Macro PDF Entry

This parameter clears all currently-stored Macro PDF data in the buffer without transmission and aborts from Macro PDF mode.

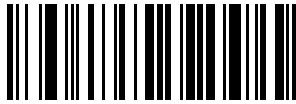

Abort Macro PDF Entry

Postal Codes

These parameters are regarding postal codes from around the globe.

US Postnet

Parameter # 89 (SSI #59h)

This parameter enables or disables US Postnet.

- Enabled - enables US Postnet.
- *Disabled - disables US Postnet.

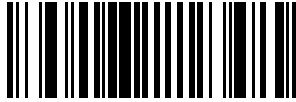

Enable US Postnet (1)

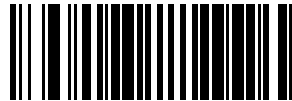

*Disable US Postnet (0)

US Planet

Parameter # 90 (SSI #5Ah)

This parameter enables or disables US Planet.

- Enabled - enables US Planet.
- *Disabled - disables US Planet.



Enable US Planet (1)

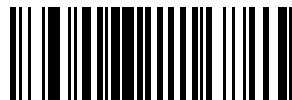

*Disable US Planet (0)

Transmit US Postal Check Digit

Parameter # 95 (SSI #5Fh)

This parameter selects whether to transmit US Postal data, which includes both US Postnet and US Planet, with or without the check digit.

- *Transmit - transmit US Postal with Check Digit.
- Do Not Transmit - do not transmit US Postal with Check Digit.

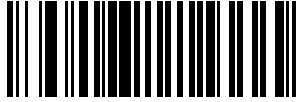

*Transmit US Postal Check Digit (1)

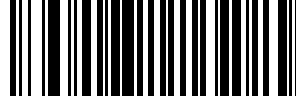

Do Not Transmit US Postal Check Digit (0)

UK Postal

Parameter # 91 (SSI # 5Bh)

This parameter enables or disables UK Postal.

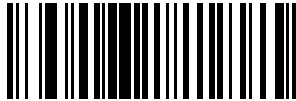

Enable UK Postal (1)

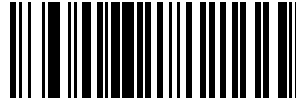

*Disable UK Postal (0)

Transmit UK Postal Check Digit

Parameter # 96 (SSI # 60h)

This parameter enables or disables Transmit UK Postal Check Digit.

Scan one of the following barcodes to select whether to transmit UK Postal data with or without the check digit.

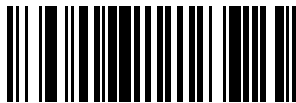

*Transmit UK Postal Check Digit (1)

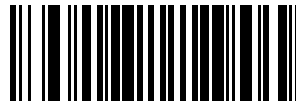

Do Not Transmit UK Postal Check Digit (0)

Japan Postal

Parameter # 290 (SSI # F0h, 22h)

This parameter enables or disables Japan Postal.



Enable Japan Postal (1)



*Disable Japan Postal (0)

Australia Post

Parameter # 291 (SSI # F0h, 23h)

This parameter enables or disables Australia Post.

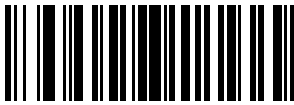

Enable Australia Post (1)



*Disable Australia Post (0)

Australia Post Format

Parameter # 718 (SSI # F1h, CEh)

This parameter enables or disables Australia Post Format.

- Autodiscriminate (or Smart mode) - Decode the Customer Information Field using the N and C Encoding Tables.



NOTE: This option increases the risk of misdecodes because the encoded data format does not specify the Encoding Table used for encoding.

- Raw Format - Output raw bar patterns as a series of numbers 0 through 3.
- Alphanumeric Encoding - Decode the Customer Information Field using the C Encoding Table.
- Numeric Encoding - Decode the Customer Information Field using the N Encoding Table.

For more information on Australia Post Encoding Tables, refer to the Australia Post Customer Barcoding Technical Specifications available at auspost.com.au.



*Autodiscriminate (0)



Alphanumeric Encoding (2)



Raw Format (1)



Numeric Encoding (3)

Netherlands KIX Code

Parameter # 326 (SSI # F0h, 46h)

This parameter enables or disables Netherlands KIX Code.

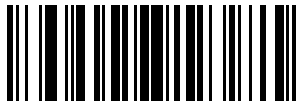

Enable Netherlands KIX Code (1)



*Disable Netherlands KIX Code (0)

USPS 4CB/One Code/Intelligent Mail

Parameter # 592 (SSI # F1h 50h)

This parameter enables or disables USPS 4CB/One Code/Intelligent Mail.

Scan one of the following barcodes to enable or disable USPS 4CB/One Code/Intelligent Mail.

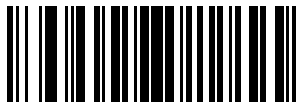

Enable USPS 4CB/One Code/Intelligent Mail (1)



*Disable USPS 4CB/One Code/Intelligent Mail (0)

UPU FICS Postal

Parameter # 611 (SSI # F1h 63h)

This parameter enables or disables Code 39.

Scan one of the following barcodes to enable or disable UPU FICS Postal.

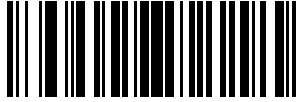

Enable UPU FICS Postal (1)

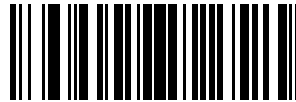

*Disable UPU FICS Postal (0)

Mailmark

Parameter # 1337 (SSI # F8h 05h 39h)

This parameter enables or disables Mailmark.

Scan one of the following barcodes to enable or disable Mailmark.

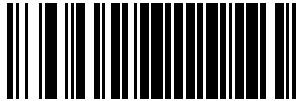

*Disable Mailmark (0)

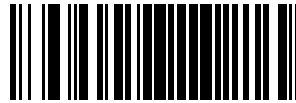

Enable Mailmark (1)

Intelligent Document Capture (Hand-Held Mode Only)

Intelligent Document Capture (IDC) is Zebra advanced image processing firmware for select imager based scanners.

This section describes IDC functionality, provides parameter barcodes to control IDC features, and includes a quick start procedure.

The Intelligent Document Capture (IDC) Process

The IDC process includes the following steps.

1. Verifies a barcode is appropriate to use as an IDC anchor or link. See [Barcode Acceptance Test](#).
2. Determines the rectangular region to capture as an image. See [Capture Region Determination](#).
3. Processes the captured image. See [Image Post Processing](#).
4. Transmits the data. See [Data Transmission](#).

Barcode Acceptance Test

Upon decoding a barcode, the scanner checks that the barcode fits the description of a barcode that anchors or links to an IDC form.

To be accepted as an IDC barcode:

- The symbology must be enabled for decode, and also enabled via [IDC Symbology](#). The IDC firmware allows enabling between zero and eight symbologies simultaneously: Code 128, Code 39, Interleaved 2 of 5, Discrete 2 of 5, Codabar, PDF417, Data Matrix, and EAN-128.
- The decoded data must satisfy the values set in the [IDC Minimum Text Length](#) and [IDC Maximum Text Length](#) parameters. To disable either of these checks, set the value to zero.

If the barcode does not satisfy both requirements, it is sent as a normal (non-IDC) decode.

An IDC barcode is required when [IDC Operating Mode](#) is set to **Anchored** or **Linked**.

Free-Form operating mode does not require a barcode, but transmits decoded data if one is found and satisfies the requirements. If no barcode is decoded, the document capture process starts but may require specifying a non-zero value for the [IDC Delay Time](#). The scanner must wait for at least this amount of time after trigger pull before capturing a document, unless a barcode is decoded before the time expires.

If [Picklist Mode](#) is enabled, the barcode must be directly under the aiming pattern and within the scanner's decode range, and the region to capture must be completely within the scanner's field-of-view.

Capture Region Determination

After accepting an IDC barcode, the firmware establishes the region to capture as an image.

The method used depends on the setting of the [IDC Operating Mode](#).

The IDC firmware emits a single low beep after successfully capturing a region. The scanner is then no longer capturing images and can be moved without disturbing the IDC output. Be sure to hold the trigger button until the decode beep, otherwise the IDC process may be aborted.

IDC Operating Mode (Anchored)

A coordinate system is built based on the barcode in its rectified (de-skewed) form. The origin is the center of the barcode, and the x-axis is set toward the right, from the barcode's point of view. The unit module width of the barcode is the unit for x. Similarly, the y-axis is set toward the up direction. The unit for the y-axis is specified via the parameter [IDC Aspect](#). This is the aspect ratio of a thin bar or space - the barcode's height is divided by this value to get this unit. Set IDC Aspect to zero to automatically calculate the aspect ratio. The barcode can be of different sizes for the same form, as long as the center of the barcode is the same when the barcode's length changes.

From this coordinate system, the IDC area is determined using four parameters: offsets in x and y ([IDC X Coordinate](#), [IDC Y Coordinate](#)) to the region's top-left corner, and width and height [IDC Width](#), [IDC Height](#)).

If the capture area is relatively large as compared to the barcode area, the calculation to obtain the capture area is prone to significant errors. A recommended solution is to enclose the form with a single black-lined rectangular border (a box), which is not in contact with any other line on the outside of the form (although it can be connected to lines on the inside of the form). When the [IDC Find Box Outline](#) is set, the firmware searches for the box, and does not decode if any edges are broken (such as by a protruding thumb).

The [IDC Zoom Limit](#) parameter controls the quality of the captured form. The IDC firmware rejects capturing a form unless the width is at least the IDC Zoom Limit percentage of the IDC Width parameter. For example, if IDC Zoom Limit is set to 100 and IDC Width Limit is set to 150, the form must be at least 300 pixels wide before it is captured (each unit module is scaled to two pixels).

The [IDC Maximum Rotation](#) parameter controls the maximum rotation any edge of the form can have in relation to the scanner's horizontal or vertical axis.

IDC Operating Mode (Free-Form or Linked)

The document capture region is a rectangular piece of paper, or a portion of it enclosed by a rectangular border.

In either case, all four sides of the capture region must be completely within the scanner's field-of-view, and there must be sufficient contrast at the border of the capture region. For example, if a piece of white paper contains the document to capture, it must be put in front of a dark background.

By default, the scanner captures the largest rectangular region within the field-of-view. To specify a particular border type, use the [IDC Border Type](#) parameter.

The region must contain at least 10% of the field-of-view in two dimensions.

If an IDC barcode is decoded, IDC uses its location to start the search for the capture region. Otherwise, it searches the capture region from the center of the field-of-view. IDC also uses the orientation of a decoded IDC barcode to orient the output image.

Image Post Processing

After determining the document capture region, the firmware de-skews and re-samples the region as follows. Enabling [IDC Captured Image Brighten](#) calls normalization, which makes the brightness of the image uniform, and enhances contrast as a large percent of background pixels is made completely white (a smaller percent of pixels is made completely black if the firmware determines there is no danger of enhancing the contrast of a very bland area). Enabling [IDC Captured Image Sharpen](#) enhances the sharpness of the image.

IDC re-samples the image about one output pixel per input pixel for **Free-Form** or **Linked** modes and two pixels-per-module in **Anchored** mode.

IDC compresses and transmits the image in one of the standard image formats selected by the [IDC File Format Selector](#), [IDC Bits Per Pixel](#), and [IDC JPEG Quality](#) parameters.



NOTE: It might take several seconds for post processing to complete, depending on the size of the captured region, the options enabled, and the scanner model.

Data Transmission

After processing the captured image, IDC assembles the image with the decoded barcode data (if applicable) into an ISO/IEC 15434 style packet and transmits it to the host.

The scanner issues the standard decode beep and the trigger can be released. Be sure to set the [USB Device Type](#) to **Symbol Native API (SNAPI) with Imaging Interface**.

PC Application and Programming Support

This application displays barcode data and/or captured images from Intelligent Document Capture enabled scanners and allows setting and reading IDC parameters.

For a sample application running on the Microsoft Windows operating system, contact your Zebra representative. Complete source code and documentation are also provided for developing custom applications. The application includes documentation for the ISO/IEC 15434 format as used by the IDC firmware and C# code to process it.

Image Document Capture Parameter Defaults

The following table lists defaults for IDC parameters. Change these values in one of two ways:

- Scan the appropriate barcodes in this section. The new value replaces the standard default value in memory. To recall default parameter values, see [Default Parameters](#).
- Configure the scanner using the 123Scan configuration program. See [123Scan and Software Tools](#).

Alternatively, use the sample application to set parameters using the parameter name. The application provides prompts and error checking to assist in setting the parameters correctly and easily. You must use an application to set a parameter to a negative value, as the [IDC X Coordinate](#) can require.

Table 28 IDC Parameter Defaults

Parameter	Parameter Name	Parameter Number ^a	SSI Number ^b	Default
Intelligent Document Capture (IDC) Parameters				

Table 28 IDC Parameter Defaults (Continued)

Parameter	Parameter Name	Parameter Number ^a	SSI Number ^b	Default
IDC Operating Mode	DocCap_MODE	594	F1h 52h	Off
IDC Symbology	DocCap_SYMBLOGY	655	F1h 8Fh	001
IDC X Coordinate	DocCap_X	596	F4h F1h 54h	-151
IDC Y Coordinate	DocCap_Y	597	F4h F1h 55h	-050
IDC Width	DocCap_WIDTH	598	F1h 56h	0300
IDC Height	DocCap_HEIGHT	599	F1h 57h	0050
IDC Aspect	DocCap_ASPECT	595	F1h 53h	000
IDC File Format Selector	DocCap_FMT	601	F1h 59h	JPEG
IDC Bits Per Pixel	DocCap_BPP	602	F1h 5Ah	8 BPP
IDC JPEG Quality	DocCap_JPEG_Qual	603	F1h 5Bh	065
IDC Find Box Outline	Sig_FINDBOX	727	F1h D7h	Disable
IDC Minimum Text Length	DocCap_MIN_TEXT	656	F1h 90h	00
IDC Maximum Text Length	DocCap_MAX_TEXT	657	F1h 91h	00
IDC Captured Image Brighten	Sig_BRIGHTEN	654	F1h 8Eh	Enable
IDC Captured Image Sharpen	Sig_SHARPEN	658	F1h 92h	Enable
IDC Border Type	DocCap_BORDER	829	F2h 3Dh	None
IDC Delay Time	DocCap_DELAY	830	F2h 3Eh	000
IDC Zoom Limit	Sig_MIN_PERCENT	651	F1h 8Bh	000
IDC Maximum Rotation	Sig_MAX_ROT	652	F1h 8Ch	00

^a Parameter number decimal values are used for programming via RSM commands.

^b SSI number hex values are used for programming via SSI commands.

IDC Operating Mode

Parameter Name DocCap_MODE # 594 (SSI # F1h 52h)

Select the operating mode of the Intelligent Document Capture firmware.

- Off - Disables the IDC feature.
- Anchored - Requires a barcode decode. The image capture region is based on this barcode.
- Free-Form - A printed border or page edge defines the image capture region. A barcode is optional.
- Linked - A printed border or page edge defines the image capture region. A barcode is required.



*Off (0)



Anchored (1)



Free-Form (2)



Linked (3)

IDC Symbology

Parameter Name DocCap_SYMBOLOGY # 655 (SSI # F1h 8Fh)

Select the option to use when Document Capture mode is not set to **Off**.



NOTE: To enable more than one symbology at a time, simply add the values together. For example, to enable PDF417, Data Matrix, and Code 39 write a value of 98 (32 + 64 + 2).

Table 29 IDC Symbologies

Symbology	Value (Decimal)
Code 128	1
Code 39	2
I 2 of 5	4
D 2 of 5	8
Codabar	16
PD 417	32
Data Matrix	64
EAN 128	128
Aztec	256

Scan IDC Symbology, and then scan three barcodes from [Numeric Barcodes](#) in the range of 000 to 255 decimal.



IDC Symbology

IDC X Coordinate

Parameter Name DocCap_X # 596 (SSI # F4h F1h 54h)

Specify the horizontal offset to the top left corner of the region to capture relative to the center of the barcode. Negative values move toward the left.



NOTE: This parameter only applies when [IDC Operating Mode](#) is set to Anchored.

You must use an application to set a negative value.

Choose IDC X Coordinate and then scan four barcodes from [Numeric Barcodes](#) in the range of +/- 1279.

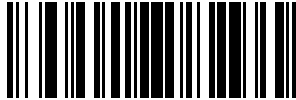

IDC X Coordinate

IDC Y Coordinate

Parameter Name DocCap_Y # 597 (SSI # F4h F1h 55h)

Specify the vertical offset to the top left corner of the region to capture relative to the center of the barcode. Negative values move toward the top.



NOTE: This parameter only applies when [IDC Operating Mode](#) is set to **Anchored**.

You must use an application to set a negative value.

Choose IDC Y Coordinate and then scan four barcodes from [Numeric Barcodes](#) in the range of +/- 1023.

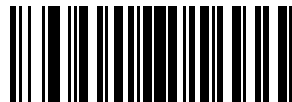

IDC Y Coordinate

IDC Width

Parameter Name DocCap_WIDTH # 598 (SSI # F1h 56h)

Specify the width of the region to capture.



NOTE: This parameter only applies when [IDC Operating Mode](#) is set to Anchored.

Choose IDC Width and then scan four barcodes from [Numeric Barcodes](#) in the range of 0000 to 1279.



IDC Width

IDC Height

Parameter Name DocCap_HEIGHT # 599 (SSI # F1h 57h)

Specify the height of the region to capture.



NOTE: This parameter only applies when [IDC Operating Mode](#) is set to Anchored.

Choose IDC X Coordinate and then scan four barcodes from [Numeric Barcodes](#) in the range of 0000 to 1279.

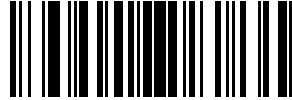

IDC Height

IDC Aspect

Parameter Name DocCap_ASPECT # 595 (SSI # F1h 53h)

Specify the barcode's aspect ratio of a thin bar or space.

The barcode's height is divided by this value to obtain the unit in the y-axis. Set this parameter to zero to calculate the aspect value automatically.



NOTE: This parameter only applies when [IDC Operating Mode](#) is set to **Anchored**.

Choose IDC X Coordinate and then scan three barcodes from [Numeric Barcodes](#) in the range of 000 to 255.

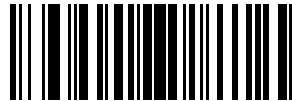

IDC Aspect

IDC File Format Selector

Parameter Name DocCap_FMT # 601 (SSI # F1h 59h)

Select a document capture file format appropriate for your system (BMP, TIFF, or JPEG). The scanner stores captured areas in the selected format.

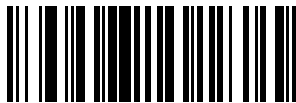

*JPEG (1)



BMP (3)

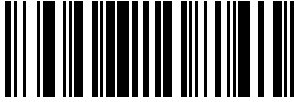

TIFF (4)

IDC Bits Per Pixel

Parameter Name DocCap_BPP # 602 (SSI # F1h 5Ah)

Select the number of significant bits per pixel (BPP) to use when capturing an image.

Select 1 BPP for a black and white image, 4 BPP to assign 1 of 16 levels of grey to each pixel, or 8 BPP to assign 1 of 256 levels of grey to each pixel.



NOTE: The scanner ignores these settings for JPEG file formats, which only support 8 BPP.

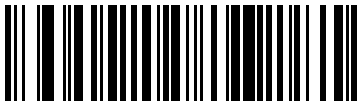

1 BPP (0)

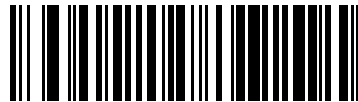

4 BPP (1)



*8 BPP (2)

IDC JPEG Quality

Parameter Name DocCap_JPEG_Qual # 603 (SSI # F1h 5Bh)

Set the amount of JPEG compression to perform on the captured image. Higher numbers produce a better quality image but larger files.

Scan IDC JPEG Quality, and then scan three barcodes from [Numeric Barcodes](#) in the range of 005 to 100 decimal.



IDC JPEG Quality

IDC Find Box Outline

Parameter Name Sig_FINDBOX # 727 (SSI # F1h D7h)

Select `Enable Find Box Outline` to search for a rectangular border during document capture.



NOTE: This parameter only applies when `IDC Operating Mode` is set to `Anchored`.



Enable Find Box Outline (1)



*Disable Find Box Outline (0)

IDC Minimum Text Length

Parameter Name `DocCap_MIN_TEXT # 656 (SSI # F1h 90h)`

Specify the minimum number of characters encoded in a barcode for the IDC firmware to use it as an anchored or linked barcode.



NOTE: Set this to zero to disable all checking and use all barcodes.

Choose `IDC Minimum Text Length` and then scan two barcodes from [Numeric Barcodes](#) in the range of 00 to 55 decimal.

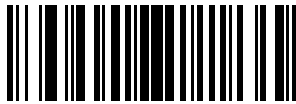

IDC Minimum Text Length

IDC Maximum Text Length

Parameter Name `DocCap_MAX_TEXT # 657 (SSI # F1h 91h)`

Specify the maximum number of characters encoded in a barcode for the IDC firmware to use as an anchored or linked barcode.



NOTE: Set this to zero to disable all checking and use all barcodes.

Choose `IDC Maximum Text Length` and then scan two barcodes from [Numeric Barcodes](#) in the range of 00 to 55 decimal.



IDC Maximum Text Length

IDC Captured Image Brighten

Parameter Name Sig_BRIGHTEN # 654 (SSI # F1h 8Eh)

Enable `Captured Image Brighten` to make image brightness uniform and enhance contrast such that a large percent of the background pixels is made completely white (a smaller percent of pixels is made completely black if the program determines there is no danger of enhancing the contrast of a very bland area).



NOTE: This parameter is also used for Signature Capture.

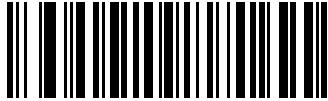

*Enable Captured Image Brighten (1)



Disable Captured Image Brighten (0)

IDC Captured Image Sharpen

Parameter Name Sig_SHARPEN # 658 (SSI # F1h 92h)

Enable this parameter to enhance the sharpness of the image.



NOTE: This parameter is also used for Signature Capture.

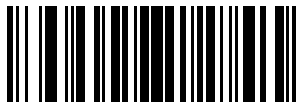

*Enable Captured Image Sharpen (1)



Disable Captured Image Sharpen (0)

IDC Border Type

Parameter Name DocCap_BORDER # 829 (SSI # F2h 3Dh)

Select the style of border used to determine the outline of the capture region.



NOTE: This parameter only applies when [IDC Operating Mode](#) is set to **Free-Form** or **Linked** .

- None - Capture the largest rectangular region within the field-of-view.
- Black - The border must be black (such as a printed rectangular border).

- White - The border must be white (e.g., paper edge on a dark background).
- Advanced Edge Detection (AED) - Capture a region defined by edges of any color and potentially broken.



*None (0)

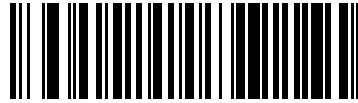

Black (1)



White (2)

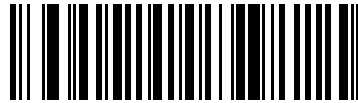

Advanced Edge Detection (AED) (3)

IDC Delay Time

Parameter Name **DocCap_DELAY # 830 (SSI # F2h 3Eh)**

Set the delay for capturing a document after a trigger pull. Decoding a barcode aborts this delay.



NOTE: This parameter only applies when [IDC Operating Mode](#) is set to `Free-Form`.

Choose IDC Delay Time and then scan three barcodes from [Numeric Barcodes](#) in the range of 000 to 200 decimal in units of 10 msec.

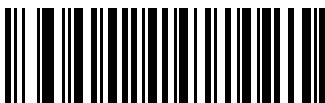

IDC Delay Time

IDC Zoom Limit

Parameter Name **Sig_MIN_PERCENT # 651 (SSI # F1h 8Bh)**

Set the minimal zoom percentage value of a form for it to be considered for capture. This controls the quality of the captured form.

The IDC firmware rejects capturing a form unless the width is at least the IDC Zoom Limit percentage of the [IDC Width](#) parameter. For example, if you set this parameter to 100 and IDC Width to 150, the form must be at least 300 pixels wide before it is captured (each unit module is scaled to two pixels).



NOTE: This parameter only applies when [IDC Operating Mode](#) is set to Anchored.

Choose IDC Zoom Limit and then scan three barcodes from [Numeric Barcodes](#) in the range of 000 to 100 percent. Set this to zero to disable all checking.



IDC Zoom Limit

IDC Maximum Rotation

Parameter Name Sig_MAX_ROT # 652 (SSI # F1h 8Ch)

Set the maximum rotation any edge of the form can have in relation to the scanner's horizontal or vertical axis for it to be considered for capture.



NOTE: This parameter only applies when [IDC Operating Mode](#) is set to Anchored.

Choose IDC Maximum Rotation and then scan two barcodes from [Numeric Barcodes](#) in the range of 00 to 45 decimal. Set this to zero to disable all checking.

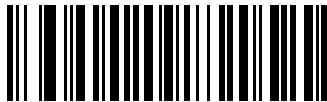

IDC Maximum Rotation

Quick Start

This section familiarizes you with some of the Intelligent Document Capture features.

[IDC Demonstrations](#) includes instructions to demonstrate the Anchored, Free-Form, and Linked modes using a sample form to provide an understanding of how to use IDC. These examples do not illustrate all capabilities of the advanced IDC firmware. Build upon these using different parameter settings and forms.

Sample IDC Setup

To set up IDC:

1. Connect a scanner equipped with IDC to the host computer's USB port.
2. To set the scanner to the default settings and proper USB host type, scan `Set Defaults` followed by the `Symbol Native API (SNAPI) with Imaging Interface` barcode. Allow time for the scanner to reset and the USB connection to remunerate after each scan before continuing.

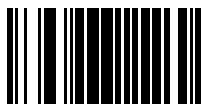

Set Defaults



Symbol Native API (SNAPI) with Imaging Interface

3. Start the sample application and select the scanner in the **SNAPI Scanners** drop-down menu.
4. Set parameters as specified in [IDC Demonstrations](#) using the sample application or by scanning parameter barcodes in this guide. The barcode in the sample form is Code 128, which is enabled by default for decoding and as a Document Capture symbology. You can change these settings for your IDC application.
5. Perform each demo. When scanning, aim the scanner at the barcode in the center of the rectangle. Pull the scanner back so the rectangle is fully contained in the aiming pattern. When you pull the trigger, the scanner emits a low tone to indicate that the IDC firmware identified and captured an image, then a decode beep to indicate that the data transmitted. There may be several seconds between the two beeps, depending on the size of the captured image and options selected (de-skew, brighten, etc). You can move the scanner after the first beep, but continue to hold the trigger or the scanner may end the session before sending the data.

IDC Demonstrations

This section provides demonstrations of the different IDC modes.

Anchored Mode Demo

Anchored mode captures an image of fixed size and location relative to a barcode on the page. Parameters control the height, width, and location.

The IDC firmware requires that a barcode is present in order to capture an image. It decodes the barcode and uses it to adjust the image to the upright orientation.

- Set [IDC Operating Mode](#) to **Anchored**.
- Set parameters to these values:
 - Set [IDC Height](#) to **100**.
 - Set [IDC Width](#) to **90**.
 - Set [IDC X Coordinate](#) to **-175**.
 - Set [IDC Y Coordinate](#) to **-50**.
- Pull the trigger. The scanner decodes the barcode and captures an image of the text scroll.
- Rotate the form clockwise so the word **Capture** is along the bottom edge, and pull the trigger. The scanner decodes the barcode and captures the same image, including orientation. (This example also works with the form rotated counter-clockwise or upside down).
- Modify the values for height, width, x, and y. Pull the trigger. The captured area changes in size and location.
- Cover the barcode with a small piece of paper (or your finger) and pull the trigger. The scanner does not decode the barcode or capture an image.

Free-Form Mode Demo

Free-Form mode captures an image where a rectangular border on the page determines the size and position. It adjusts the image to the upright orientation if a barcode is found and decoded in the image.

- Set [IDC Operating Mode](#) to **Free-Form**.
- Pull the trigger. The scanner decodes the barcode and captures an image of the entire rectangle, including the contents.
- Modify the values for height, width, x, and y. Pull the trigger. Note that the captured image is not affected.
- Rotate the form clockwise so the word **Capture** is along the bottom edge, and pull the trigger. The scanner decodes the barcode and captures the same image, including orientation. (This example also works with the form rotated counterclockwise or upside down).
- Cover the barcode with a small piece of paper and pull the trigger. The scanner does not decode the barcode and does not re-orient the captured image to the normal position, i.e., with the logo in the upper-left corner.

Linked Mode Demo

Linked mode captures an image where a rectangular border on the page determines the size and position. The IDC firmware requires that a barcode is present in order to capture an image. It decodes the barcode and uses it to adjust the image to the upright orientation.

- Set [IDC Operating Mode](#) to **Linked**.
- Use the examples from the [Free-Form Mode Demo](#), noting that the last item (covering the barcode) does not decode the barcode or capture an image.

Other Suggestions

Hold the scanner at an angle (up/down or side to side) to the page instead of perpendicular to it.

The IDC firmware de-skews and adjusts the brightness (enabled by default) to produce a quality image when the scanner is held at less than ideal conditions.

Quick Start Form

Use this form to practice the Quick Start demonstrations.

Figure 13 Quick Start Form

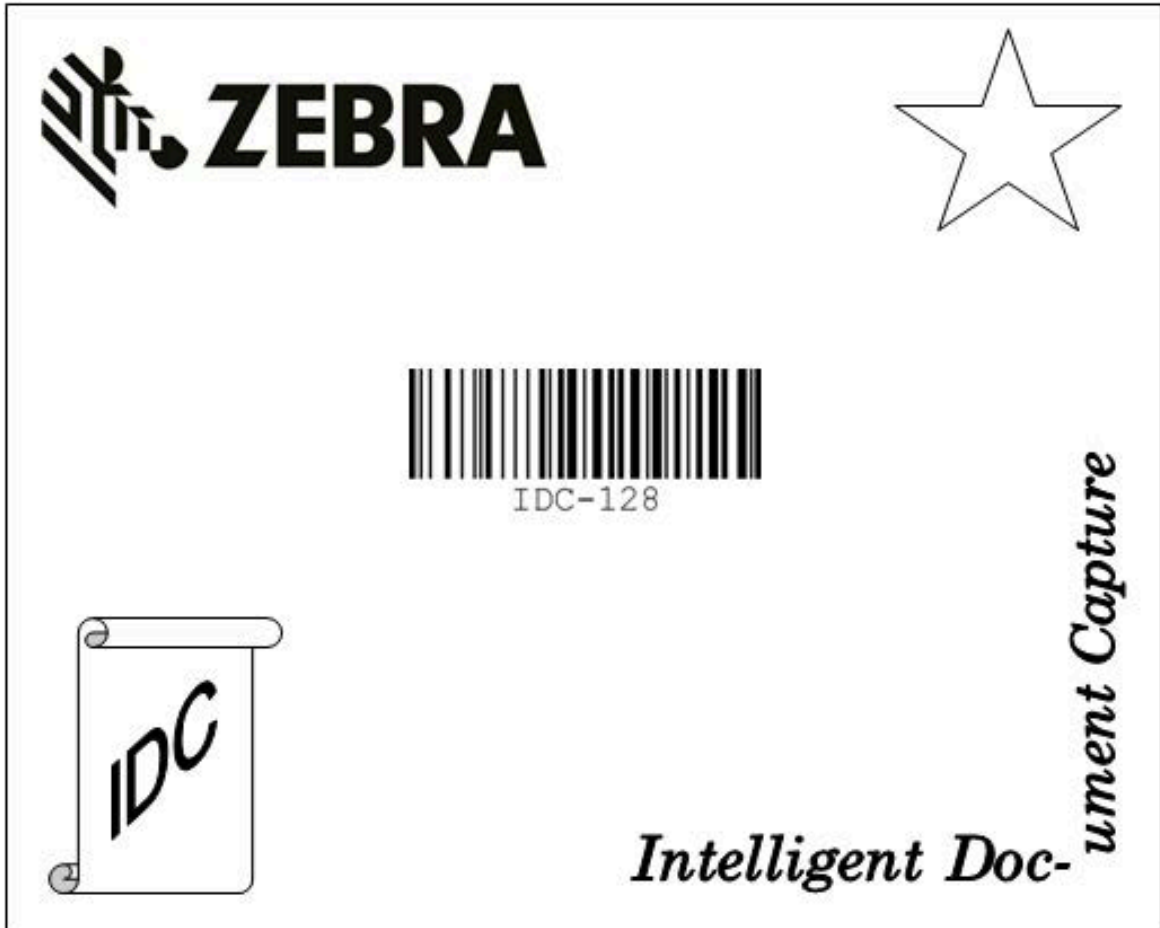

OCR Programming

This section describes how to set up the scanner for OCR programming. The scanner can read 6 to 60-point OCR typeface. It supports font types OCR-A, OCR-B, MICR-E13B, and US Currency Serial Number.

OCR is not as secure as a barcode. To decrease OCR misdecodes and speed OCR reading, set an accurate OCR template and character subset, and use a check digit.

All OCR fonts are disabled by default. You can enable OCR-A and OCR-B at the same time but not other combined font types.

OCR Programming Defaults

OCR Programming Defaults lists the defaults for OCR parameters.

Table 30 OCR Programming Defaults

Parameter	Parameter Number	SSI Number	Default
OCR-A	680	F1h A8h	Disable
OCR-A Variant	684	F1h ACh	Full ASCII
OCR-B	681	F1h A9h	Disable
OCR-B Variant	685	F1h ADh	Full ASCII
MICR E13B	682	F1h AAh	Disable
US Currency	683	F1h ABh	Disable
OCR Orientation	687	F1h AFh	0°
OCR Lines	691	F1h B3h	1
OCR Minimum Characters	689	F1h B1h	3
OCR Maximum Characters	690	F1h B2h	100
OCR Subset	686	F1h AEh	Selected font variant
OCR Quiet Zone	695	F1h B7h	50
OCR Template	547	F1h 23h	99999999
OCR Check Digit Modulus	688	F1h B0h	1
OCR Check Digit Multiplier	700	F1h BCh	1212121212
OCR Check Digit Validation	694	F1h B6h	None

Table 30 OCR Programming Defaults (Continued)

Parameter	Parameter Number	SSI Number	Default
Inverse OCR	856	F2h 58h	Regular
OCR Redundancy	1770	F8h 06h EAh	Level 1

OCR Programming Parameters

The OCR programming parameters enable scanners to read font types for OCR-A, OCR-B, MICR-E13B, and US Currency Serial Numbers.

OCR-A

Parameter # 680 (SSI # F1h A8h)

This parameter enables scanners to read OCR-A fonts.

- Enabled - OCR-A can be read by the scanner.
- Disabled - OCR-A fonts will not be read by the scanner.



NOTE: OCR is not as secure as a barcode. To decrease OCR misdecodes and speed OCR reading, set an accurate OCR template and character subset, and use a check digit. See [OCR Subset](#) and [OCR Template](#).

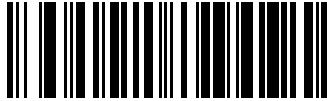

Enable OCR-A (1)



*Disable OCR-A (0)

OCR-A Variant

Parameter # 684 (SSI # F1 ACh)

This parameter enables scanners to read OCR-A font variants.

The font variant sets a processing algorithm and default character subset for the given font. Select the most appropriate font variant to optimize performance and accuracy.

OCR-A supports the following variants:

- OCR-A Full ASCII

```
!"#$%()*+,-./0123456789<>ABCDEFGHIJKLMNOPQRSTUVWXYZ\^
```

- OCR-A Reserved 1

\$*+- ./0123456789ABCDEFGHIJKLMNOPQRSTUVWXYZ

- OCR-A Reserved 2

\$*+- ./0123456789<>ABCDEFGHIJKLMNOPQRSTUVWXYZ

- OCR-A Banking

-0123456789<>

Special banking characters output as the following representative characters:

- ℥ outputs as f
- ℥ outputs as c
- ℥ outputs as h



NOTE: Enable OCR-A before setting this parameter. If disabling OCR-A, set the variant to OCR-A Full ASCII.

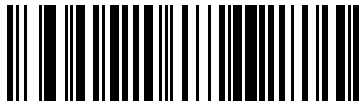

*OCR-A Full ASCII (0)

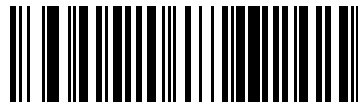

OCR-A Reserved 1 (1)

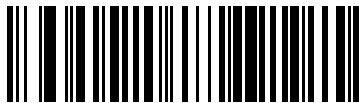

OCR-A Reserved 2 (2)



OCR-A Banking (3)

OCR-B

Parameter # 681 (SSI # F1h A9h)

This parameter enables scanners to read OCR-B fonts.

- Enabled - OCR-B can be read by the scanner.
- Disabled - OCR-B fonts will not be read by the scanner..



NOTE: OCR is not as secure as a barcode. To decrease OCR misdecodes and speed OCR reading, set an accurate OCR template and character subset, and use a check digit. See [OCR Subset](#) and [OCR Template](#).



Enable OCR-B (1)



*Disable OCR-B (0)

OCR-B Variant

Parameter # 685 (SSI # F1h ADh)

This parameter enables scanners to read OCR-A font variants.

OCR-A supports the following variants:

- OCR-B Full ASCII

```
!#$%()*+,-./0123456789<>ABCDEFGHIJKLMNPOQRSTUVWXYZ^|~Ñ
```

- OCR-B Banking

```
#+-0123456789<>JNP|
```

- OCR-B Limited

```
+, -./0123456789<>ACENPSTVX
```

- OCR-B ISBN 10-Digit Book Numbers

```
-0123456789>BCEINPSXz
```

- OCR-B ISBN 10 or 13-Digit Book Numbers

```
-0123456789>BCEINPSXz
```

- OCR-B Travel Document Version 1 (TD1) 3-Line ID Cards

```
-0123456789<ABCDEFGHIJKLMNPOQRSTUVWXYZ
```

- OCR-B Travel Document Version 2 (TD2) 2-Line ID Cards

```
-0123456789<ABCDEFGHIJKLMNPOQRSTUVWXYZ
```

- OCR-B Travel Document 2 or 3-Line ID Cards Auto-Detect

```
!#$%()*+,-./0123456789<>ABCDEFGHIJKLMNOPQRSTUVWXYZ^|Ñ
```

- OCR-B Passport

```
-0123456789<ABCDEFGHIJKLMNOPQRSTUVWXYZÑ
```

- OCR-B Visa Type A

```
-0123456789<ABCDEFGHIJKLMNOPQRSTUVWXYZ
```

- OCR-B Visa Type B

```
-0123456789<ABCDEFGHIJKLMNOPQRSTUVWXYZÑ
```

- OCR-B ICAO Travel Documents

This allows reading either TD1, TD2, Passport, Visa Type A, or Visa Type B without switching between these options. It automatically recognizes the travel document read.

Selecting one of the ISBN Book Numbers automatically applies the appropriate ISBN checksum, so setting this is not required.

Selecting the following OCR-B variants automatically sets the appropriate [OCR Lines](#). These five variants invoke extensive special algorithms and checking for that particular document type:

Variant	OCR Lines Setting
Passport	2
TD1 ID Cards	3
TD2 ID Cards	2
Visa Type A	2
Visa Type B	2

If you set one of these variants with both OCR-A and OCR-B enabled, only the specified travel document is read without reading OCR-A. Returning OCR-B variant to its default (Full ASCII) allows reading OCR-A.

For the best performance in passport reading, fix the target passport and the scanner in place (6.5 - 7.5”).



NOTE: Enable OCR-B before setting this parameter. If disabling OCR-B, set the variant to OCR-B Full ASCII.

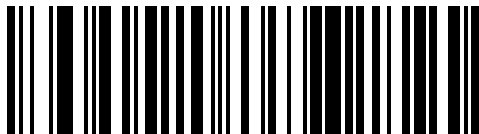

*OCR-B Full ASCII (0)

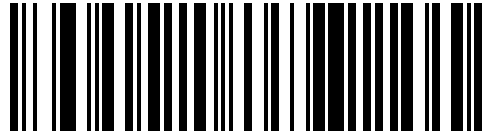

OCR-B Banking (1)



OCR-B Limited (2)

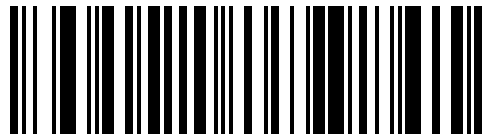

OCR-B ISBN 10-Digit Book Numbers (6)

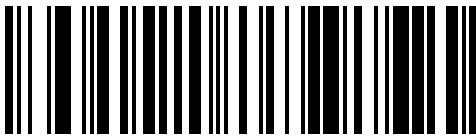

OCR-B ISBN 10 or 13-Digit Book Numbers (7)

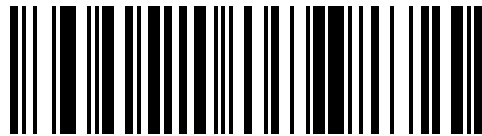

OCR-B Travel Document Version 1 (TD1) 3 Line ID Cards (3)

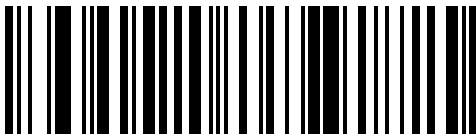

OCR-B Travel Document Version 2 (TD2) 2-Line ID Cards (8)



Travel Document 2 or 3-Line ID Cards Auto-Detect (20)

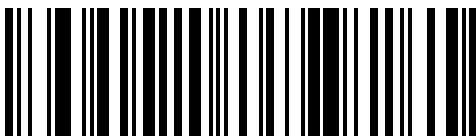

OCR-B Passport (4)

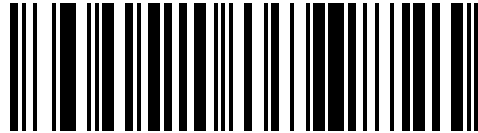

OCR-B Visa Type A (9)

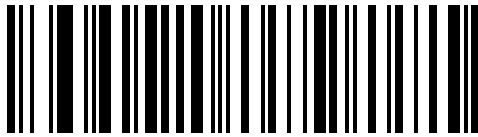

OCR-B Visa Type B (10)

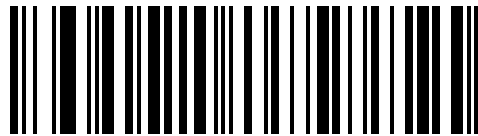

OCR-B ICAO Travel Documents (11)

MICR E13B

Parameter # 682 (SSI # F1h AAh)

This parameter enables scanners to read MICR E13B fonts.

MICR E 13B uses the following characters:

1 2 3 4 5 6 7 8 9 0 . : ; ' | " ' " ' "

TOAD characters (Transit, On Us, Amount, and Dash) output as the following representative characters:

┆ outputs as **t**

┆' outputs as **a**

┆" outputs as **o**

┆" outputs as **d**

- Enabled - MICR E13B fonts can be read by the scanner.
- Disabled -MICR E13B fonts will not be read by the scanner..



NOTE: OCR is not as secure as a barcode. To decrease OCR misdecodes and speed OCR reading, set an accurate OCR template and character subset, and use a check digit. See [OCR Subset](#) and [OCR Template](#).



Enable MICR E13B (1)

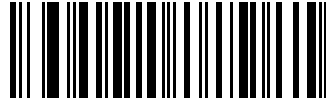

*Disable MICR E13B (0)

US Currency Serial Number

Parameter # 683 (SSI # F1h ABh)

This parameter enables scanners to read US Currency Serial Numbers.

- Enabled - US Currency Serial Numbers can be read by the scanner.
- Disabled - US Currency Serial Numbers will not be read by the scanner..



NOTE: OCR is not as secure as a barcode. To decrease OCR misdecodes and speed OCR reading, set an accurate OCR template and character subset, and use a check digit. See [OCR Subset](#) and [OCR Template](#).

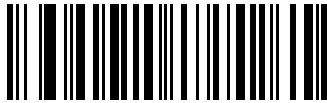

Enable US Currency (1)



*Disable US Currency (0)

OCR Orientation

Parameter # 687 (SSI # F1h AFh)

This parameter specifies the orientation of the OCR to read to the imaging engine.

- OCR Orientation 0°
- OCR Orientation 270° clockwise (or 90° counterclockwise)
- OCR Orientation 180° (upside down)
- OCR Orientation 90° clockwise
- OCR Orientation Omnidirectional

Setting an incorrect orientation can cause misdecodes.



*OCR Orientation 0° (0)



OCR Orientation 270° Clockwise (1)



OCR Orientation 180° Clockwise (2)



OCR Orientation 90° Clockwise (3)



OCR Orientation Omnidirectional (4)

OCR Lines

Parameter # 691 (SSI # F1h B3h)

This parameter selects the number of OCR lines to decode.

Selecting Visas, TD1, or TD2 ID cards automatically sets the appropriate **OCR Lines**. Also see [OCR-B Variant](#).



*OCR 1 Line (1)

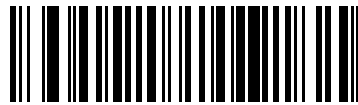

OCR 2 Lines (2)



OCR 3 Lines (3)

OCR Minimum Characters

Parameter # 689 (SSI # F1h B1h)

This parameter selects the minimum number of OCR characters (not including spaces) per line to decode.

Scan OCR Minimum Characters, then scan a three-digit number between 003 and 100 using the barcodes in [Numeric Barcodes](#) representing the number of OCR characters to decode. Strings of OCR characters less than the minimum are ignored.



OCR Minimum Characters

OCR Maximum Characters

Parameter # 690 (SSI # F1h B2h)

This parameter selects the maximum number of OCR characters (including spaces) per line to decode.

Scan OCR Maximum Characters, then scan a three-digit number between 003 and 100 using the barcodes in [Numeric Barcodes](#) representing the number of OCR characters to decode. Strings of OCR characters greater than the maximum are ignored.



OCR Maximum Characters

OCR Subset

Parameter # 686 (SSI # F1h AEh)

This parameter creates an OCR subset to define a custom group of characters in place of a preset font variant.

For example, if scanning only numbers and the letters A, B, and C, create a subset of just these characters to speed decoding. This applies a designated OCR Subset across all enabled OCR fonts.

To cancel an OCR subset, for OCR-A or OCR-B, scan OCR-A variant Full ASCII, or OCR-B variant Full ASCII.

For MICR E13B or US Currency Serial Number, create a subset which includes all allowed characters in that character set, or scan an option from the [Default Parameters](#) and re-program the scanner.

Setting or Modifying the OCR Font Subset

To set or modify the OCR Font Subset, follow this procedure.

1. Enable the appropriate OCR font(s).
2. Scan the **OCR Subset** barcode.



OCR Subset

3. Scan numbers and letters from [Alphanumeric Barcodes](#) to form the OCR Subset.
4. Scan [OCR Subset](#).

OCR Quiet Zone

Parameter # 695 (SSI # F1h B7h)

This parameter sets the OCR quiet zone.

The scanner stops scanning a field when it detects a sufficiently wide blank space. The width of this space is defined by the End of Field option. Used with parsers that tolerate slanted characters, the End of Field count is approximately a count of 8 for a character width. For example, if set to 15, then two character widths are an end of line indicator for the parser. Larger end of field numbers require bigger quiet zones at each end of text line.

Scan quiet zone, then scan a two-digit number using the numeric keypad in [Alphanumeric Barcodes](#). The range of the quiet zone is 20 - 99.

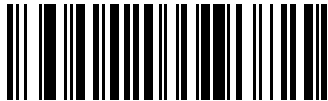

OCR Quiet Zone

OCR Template

Parameter # 547 (SSI # F1h 23h)

This parameter creates a template for precisely matching scanned OCR characters to a desired input format.

Carefully constructing an OCR template eliminates scanning errors.

To set or modify the OCR decode template, scan [OCR Template](#), and then scan barcodes on the following pages that correspond to numbers and letters to form the template expression. Finally, scan **End of Message**.



OCR Template

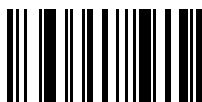

End of Message

Required Digit (9)

Only a numeric character is allowed in this position.

Template	Valid data	Valid data	Invalid data
99999	12987	30517	123AB



9

Required Alpha (A)

Only an alpha character is allowed in this position.

Template	Valid data	Valid data	Invalid data
AAAAA	ABCDE	UVWXY	12FGH

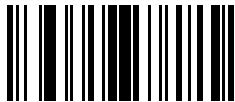

A

Require and Suppress (0)

Any character in this position, including space or reject, is suppressed from the output.

Template	Incoming data	Output
990AA	12QAB	12AB



0

Optional Alphanumeric (1)

An alphanumeric character is accepted in this position if present. Optional characters are not allowed as the first character(s) in a field of like characters.

Template	Valid data	Valid data	Invalid data
99991	1234A	12345	1234<



1

Optional Alpha (2)

An alpha character is accepted in this position if present. Optional characters are not allowed as the first character(s) in a field of like characters.

Template	Valid data	Valid data	Invalid data
AAAA2	ABCDE	WXYZ	ABCD6



2

Alpha or Digit (3)

An alphanumeric character is required in this position to validate the incoming data.

Template	Valid data	Valid data	Invalid data
33333	12ABC	WXY34	12AB<

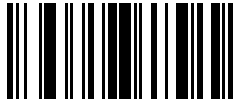

3

Any Including Space & Reject (4)

Any character is accepted in this position, including space and reject. An underscore (_) represents rejects in the output. This is a good selection for troubleshooting.

Template	Valid data	Valid data
99499	12\$34	34 98



4

Any except Space & Reject (5)

Any character is accepted in this position, except a space or reject.

Template	Valid data	Valid data	Invalid data
55999	A.123	*Z456	A BCD



5

Optional Digit (7)

A numeric character is accepted if present. Optional characters are not allowed as the first character(s) in a field of like characters.

Template	Valid data	Valid data	Invalid data
99977	12345	789	789AB



7

Digit or Fill (8)

Any numeric or fill character is accepted in this position.

Template	Valid data	Valid data	Valid data
88899	12345	>>789	<<789



8

Alpha or Fill (F)

Any alpha or fill character is accepted in this position.

Template	Valid data	Valid data	Valid data
AAAFF	ABCXY	LMN>>	ABC<5

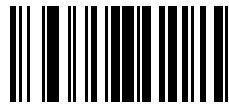

F

Optional Space ()

A space is accepted if present. Optional characters are not allowed as the first character(s) in a field of like characters.

Template	Valid data	Valid data	Invalid data
99 99	12 34	1234	67891



Space

Optional Small Special (.)

A special character is accepted if present. Optional characters are not allowed as the first character(s) in a field of like characters. Small special characters are - , and .

Template	Valid data	Valid data	Invalid data
AA.99	MN.35	XY98	XYZ12



.

Other Template Operators

These template operators assist in capturing, delimiting, and formatting scanned OCR data.

Literal String (" and +)

Use either of these delimiting characters surrounding characters from the alphanumeric keyboard in [Alphanumeric Barcodes](#) to define a literal string within a template that must be present in scanned OCR data. There are two characters used to delimit required literal strings; if one of the delimiter characters is present in the desired literal string, use the other delimiter.

Template	Valid data	Invalid data
"35+BC"	35+BC	AB+22



"



+

New Line (E)

To create a template of multiple lines, add **E** between the template of each single line.

Template	Valid data	Valid data	Invalid data
999EAAAA	321	987	XYZW
	BCAD	ZXYW	12



E

String Extract (C)

This operator, combined with others, defines a string of characters to extract from the scanned data. The string extract is structured as follows:

CbPe

Where:

- C is the string extract operator
- b is the string begin delimiter
- P is the category (one or more numeric or alpha characters) describing the string representation
- e is the string end delimiter

Values for b and e can be any scannable character. They are included in the output stream.

Template	Incoming data	Output
C>A>	XQ3>ABCDE>	>ABCDE>
	->ATHRUZ>123	>ATHRUZ>
	1ABCXYZ	No Output



C

Ignore to End of Field (D)

This operator causes all characters after a template to be ignored. Use this as the last character in a template expression. Examples for the template 999D:

Template	Incoming data	Output
999D	123-PED	123
	357298	357
	193	193



D

Skip Until (P1)

This operator skips over characters until a specific character type or a literal string is detected. It can be used in two ways:

```
P1ct
```

Where:

- P1 is the Skip Until operator
- c is the type of character that triggers the start of output
- t is one or more template characters

```
P1"s"t
```

Where:

- P1 is the Skip Until operator
- "s" is one or more literal string characters (for example, "+") that trigger the start of output
- t is one or more template characters

The trigger character or literal string is included in output from a Skip Until operator, and the first character in the template should accommodate this trigger.

Template	Incoming data	Output
P1"PN"AA9999	123PN9876	PN9876
	PN1234	PN1234
	X-PN3592	PN3592

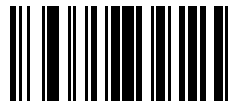

P



1

Skip Until Not (P0)

This operator skips over characters until a specific character type or a literal string is not matched in the output stream. It can be used in two ways:

```
P0ct
```

Where:

- P0 is the Skip Until Not operator
- c is the type of character that triggers the start of output

- t is one or more template characters

P0"s"t

Where:

- P0 is the Skip Until Not operator
- "s" is one or more literal string characters (for example, "+") that trigger the start of output
- t is one or more template characters

The trigger character or literal string is not included in output from a Skip Until Not operator.

Template	Incoming data	Output
P0A9999	BPN3456	3456
	PN1234	1234
	5341	No output

Template	Incoming data	Output
P0"PN"9999	PN3456	3456
	5341	No output
	PNPN7654	7654

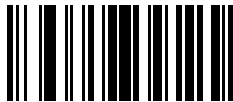

P

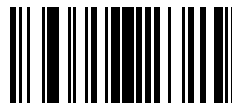

0

Repeat Previous (R)

This operator allows a template character to repeat one or more times, allowing the capture of variable-length scanned data. The following examples capture two required alpha characters followed by one or more required digits:

Template	Incoming data	Output
AA9R	AB3	AB3
	PN12345	PN12345
	32RM52700	No output



R

Scroll Until Match (S)

This operator steps through scanned data one character at a time until the data matches the template.

Template	Incoming data	Output
S99999	AB3	No Output
	PN12345	12345
	32RM52700	52700

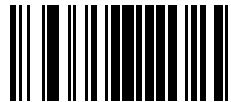

S

Multiple Templates

This feature sets up multiple templates for OCR decoding.

To create multiple templates, see [OCR Template](#), and for each template in the multiple template string, using a capital letter X as a separator between templates.

For example, set the OCR template as **99999XAAAAA** to decode OCR strings of either **12345** or **ABCDE**.

Template Examples

Following are sample templates with descriptions of valid data for each definition.

Field Definition	Description
"M"99977	M followed by three digits and two optional digits.
"X"997777"X"	X followed by two digits, four optional digits, and an X .
9959775599	Two digits followed by any character, a digit, two optional digits, any two characters, and two digits.
A55"-"999"-"99	A letter followed by two characters, a dash, three digits, a dash, and two digits.
33A"."99	Two alphanumeric characters followed by a letter, a period, and two digits.

999992991

Five digits followed by an optional alpha, two digits, and an optional alphanumeric.

"PN98"

Literal field - **PN98**

OCR Check Digit Modulus

Parameter # 688 (SSI # F1h B0h)

This parameter sets the OCR module check digit calculation.

The check digit is the last digit (in the right-most position) in an OCR string and improves the accuracy of the collected data. The calculation is performed on incoming data to determine this check digit, based on the numeric weight of the alpha and numeric characters. See [OCR Check Digit Multiplier](#). If the incoming data does not match the check digit, the data is considered corrupt.

The selected check digit option does not take effect until you set [OCR Check Digit Validation](#).

To choose the Check Digit Modulus, such as 10 for Modulus 10, scan OCR Check Digit, and then scan a three-digit number from 001 to 099 representing the check digit using the numeric keypad in [Numeric Barcodes](#).

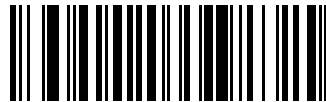

OCR Check Digit

OCR Check Digit Multiplier

Parameter # 700 (SSI # F1h BCh)

This parameter sets OCR check digit multipliers for character positions.

For check digit validation, each character in scanned data has an assigned weight to use in calculating the check digit. The scanner OCR ships with the following weight equivalents:

0 = 0	A = 10	K = 20	U = 30
1 = 1	B = 11	L = 21	V = 31
2 = 2	C = 12	M = 22	W = 32
3 = 3	D = 13	N = 23	X = 33
4 = 4	E = 14	O = 24	Y = 34
5 = 5	F = 15	P = 25	Z = 35
6 = 6	G = 16	Q = 26	Space = 0
7 = 7	H = 17	R = 27	
8 = 8	I = 18	S = 28	
9 = 9	J = 19	T = 29	

All other characters are equivalent to one (1).

You can define the multiplier string if it is different from the default.



NOTE: 123456789A (for ISBN, Product Add Right to Left. See [OCR Check Digit Validation](#))

For example:

ISBN	0	2	0	1	1	8	3	9	9	4	
Multiplier	10	9	8	7	6	5	4	3	2	1	
Product	0	18	0	7	6	40	12	27	18	4	
Product add	0+	18+	0+	7+	6+	40+	12+	27+	18+	4=	132

ISBN uses Modulus 11 for the check digit. In this case, 132 is divisible by 11, so it passes the check digit.

To set the check digit multiplier, scan OCR Check Digit Multiplier, and then scan numbers and letters to form the multiplier string before scanning End of Message from [Alphanumeric Barcodes](#)

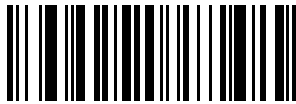

OCR Check Digit Multiplier

OCR Check Digit Validation

Parameter # 694 (SSI # F1h B6h)

This parameter protects against scanning errors by applying a check digit validation scheme.

None

No check digit validation, indicating no check digit is applied.



*No Check Digit (0)

Product Add Left to Right

This parameter helps validate the check digit.

Each character in the scanned data is assigned a numeric value (see [OCR Check Digit Multiplier](#)). Each digit representing a character in the scanned data is multiplied by its corresponding digit in the multiplier, and the sum of these products is computed. The check digit passes if this sum modulo Check Digit Modulus is zero.

For example:

Scanned data numeric value is 132456 (check digit is 6)

Check digit multiplier string is 123456

Digit	1	3	2	4	5	6
-------	---	---	---	---	---	---

Multiplier	1	2	3	4	5	6	
Product	1	6	6	16	25	36	
Product add	1+	6+	6+	16+	25+	36=	90

The Check Digit Modulus is 10. It passes because 90 is divisible by 10 (the remainder is zero).

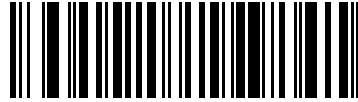

Product Add Left to Right (3)

Product Add Right to Left

This parameter changes the order of the numeric values the check digit multiplier uses with the Check Digit Modulus.

Each character in the scanned data is assigned a numeric value (see [OCR Check Digit Multiplier](#)). The check digit multiplier is reversed in order. Each value representing a character in the scanned data is multiplied by its corresponding digit in the reversed multiplier, resulting in a product for each character in the scanned data. The sum of these products is computed. The check digit passes if this sum modulo Check Digit Modulus is zero.

For example:

Scanned data numeric value is 132459 (check digit is 9)

Check digit multiplier string is 123456

Digit	1	3	2	4	5	9	
Multiplier	6	5	4	3	2	1	
Product	6	15	8	12	10	9	
Product add	6+	15+	8+	12+	10+	9=	60

The Check Digit Modulus is 10. It passes because 60 is divisible by 10 (the remainder is 0).



Product Add Right to Left (1)

Digit Add Left to Right

This parameter adds individual digits from left to right to use in the Check Digit Modulus.

Each character in the scanned data is assigned a numeric value (see [OCR Check Digit Multiplier](#)). Each value representing a character in the scanned data is multiplied by its corresponding digit in the multiplier, resulting in a product for each character in the scanned data. The sum of each individual digit in all of the products is then calculated. The check digit passes if this sum modulo Check Digit Modulus is zero.

For example:

Scanned data numeric value is 132456 (check digit is 6)

Check digit multiplier string is 123456

Digit	1	3	2	4	5	6	
Multiplier	1	2	3	4	5	6	
Product	1	6	6	16	25	36	
Digit add	1+	6+	6+	1+6+	2+5+	3+6=	36

The Check Digit Modulus is 12. It passes because 36 is divisible by 12 (the remainder is 0).



Digit Add Left to Right (4)

Digit Add Right to Left

This parameter adds individual digits from right to left to use in the Check Digit Modulus.

Each character in the scanned data is assigned a numeric value (see [OCR Check Digit Multiplier](#)). The check digit multiplier is reversed in order. Each value representing a character in the scanned data is multiplied by its corresponding digit in the reversed multiplier, resulting in a product for each character in the scanned data. The sum of each individual digit in all of the products is then calculated. The check digit passes if this sum modulo Check Digit Modulus is zero.

For example:

Scanned data numeric value is 132456 (check digit is 6)

Check digit multiplier string is 123456

Digit	1	3	2	4	5	6	
Multiplier	6	5	4	3	2	1	
Product	6	15	8	12	10	6	
Digit add	6+	1+5+	8+	1+2+	1+0+	6=	30

The Check Digit Modulus is 10. It passes because 30 is divisible by 10 (the remainder is 0).



Digit Add Right to Left (2)

Product Add Right to Left Simple Remainder

This parameter reverses the order of the check digit multiplier before adding the product to use in the Check Digit Modulus.

Each character in the scanned data is assigned a numeric value (see [OCR Check Digit Multiplier](#)). The check digit multiplier is reversed in order. Each value representing a character in the scanned data is multiplied by its corresponding digit in the reversed multiplier, resulting in a product for each character in the scanned data. The sum of these products **except for the check digit's product** is computed. The check digit passes if this sum modulo Check Digit Modulus is equal to the check digit's product.

For example:

Scanned data numeric value is 122456 (check digit is 6)

Check digit multiplier string is 123456

Digit	1	2	2	4	5		6
Multiplier	6	5	4	3	2		1
Product	6	10	8	12	10		6
Product add	6+	10+	8+	12+	10=	46	6

The Check Digit Modulus is 10. It passes because 46 divided by 10 leaves a remainder of 6.

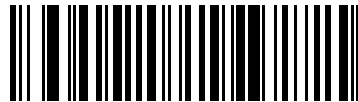

Product Add Right to Left Simple Remainder (5)

Digit Add Right To Left Simple Remainder

This parameter reverses the order of the check digit multiplier before adding the product and checking the remainder to use in the Check Digit Modulus.

Each character in the scanned data is assigned a numeric value (see [OCR Check Digit Multiplier](#)). The check digit multiplier is reversed in order. Each value representing a character in the scanned data is multiplied by its corresponding digit in the reversed multiplier, resulting in a product for each character in the scanned data. The sum of each individual digit in all of the products **except for the check digit's product** is then calculated. The check digit passes if this sum modulo Check Digit Modulus is equal to the check digit's product.

For example:

Scanned data numeric value is 122459 (check digit is 6) Check digit multiplier string is 123456

Digit	1	2	2	4	5		9
Multiplier	6	5	4	3	2		1
Product	6	10	8	12	10		9
Digit add	6+	1+0+	8+	1+2+	1+0=	19	9

The Check Digit Modulus is 10. It passes because 19 divided by 10 leaves a remainder of 9.



Digit Add Right to Left Simple Remainder (6)

Health Industry - HIBCC43

This parameter is the health industry module 43 check digit standard.

The check digit is the modulus 43 sum of all the character values in a given message, and is printed as the last character in a given message.

Example:

Supplier Labelling Data Structure: + A 1 2 3 B J C 5 D 6 E 7 1

Sum of values: $41+10+1+2+3+11+19+12+5+13+6+14+7+1 = 145$

Divide 145 by 43. The quotient is 3 with a remainder of 16. The check digit is the character corresponding to the value of the remainder, which in this example is 16, or G. The complete Supplier Labeling Data Structure, including the check digit, therefore is:

A 1 2 3 B J C 5 D 6 E 7 1 G

Numeric Value Assignments for Computing HIBC LIC Data Format Check Digit

0 = 0	9 = 9	I = 18	R = 27	- = 36
1 = 1	A = 10	J = 19	S = 28	. = 37
2 = 2	B = 11	K = 20	T = 29	Space = 38
3 = 3	C = 12	L = 21	U = 30	\$ = 39
4 = 4	D = 13	M = 22	V = 31	/ = 40
5 = 5	E = 14	N = 23	W = 32	+ = 41
6 = 6	F = 15	O = 24	X = 33	% = 42
7 = 7	G = 16	P = 25	Y = 34	
8 = 8	H = 17	Q = 26	Z = 35	



Health Industry - HIBCC43 (9)

Inverse OCR

Parameter # 856 (SSI # F2h 58h)

This parameter can read white or light words on a black or dark background.

- Regular Only - Decode regular OCR (black on white) strings only.
- Inverse Only - Decode inverse OCR (white on black) strings only.
- Autodiscriminate - Decode both regular and inverse OCR strings.



*Regular Only (0)



Inverse Only (1)

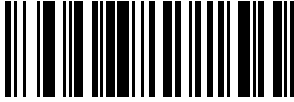

Autodiscriminate (2)

OCR Redundancy

Parameter # 1770 (SSI # F8h 06h EAh)

This parameter adjusts the number of times to decode an OCR text string before transmission.

There are three levels of OCR decode redundancy. There is an inverse relationship between the redundancy level and OCR decoding aggressiveness. Increasing the level of the redundancy can reduce OCR scanning aggressiveness, so select only the level of redundancy necessary.

- OCR Redundancy Level 1 - This setting allows the scanner to operate in its most aggressive state while providing sufficient accuracy in decoding most in-spec OCR text strings.
- OCR Redundancy Level 2 - This setting eliminates most misdecodes while maintaining reasonable aggressiveness.
- OCR Redundancy Level 3 - Select this option with greater redundancy requirements if OCR Redundancy Level 2 fails to eliminate misdecodes.



*OCR Redundancy Level 1 (1)



OCR Redundancy Level 2 (2)

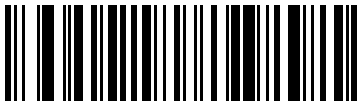

OCR Redundancy Level 3 (3)

Driver's License Set Up

The scanner uses internally embedded algorithms to parse out barcode information from standard US driver's licenses and certain other American Association of Motor Vehicle Administrators (AAMVA) compliant ID cards. Scanning these barcodes produces formatted data for use in age verification, credit card application information, and more.



NOTE: Only applies to -DL and -LL model digital scanners. North America configurations only.

This section describes how to program the scanner to read and use the data contained in the 2D barcodes on US driver's licenses and AAMVA compliant ID cards.

Table 31 DL Parsing Parameter Table

Parameter	Default
DL Parsing Parameters	
Driver's License Parsing	No Driver's License Parsing
Parsing Driver's License Data Fields	N/A
Driver's License Parse Rules	N/A
AAMVA Parse Fields	N/A
Set Default Parameter	N/A
Output Gender as M or F	N/A
Date Format	CCYYMMDD
No Separator	N/A
Send Keystroke Control Characters Keyboard Characters	N/A
Parsing Rule Example	N/A
Embedded Driver's License Parsing ADF Example	N/A

Driver's License Parsing

Parameter # 645 (SSI #F1 85)

This parameter enables driver's license parsing on the scanner.



NOTE: This does not require Zebra software (.DLL).

Choose more options in the order indicating the sequence of data fields that the scanner outputs. See [Parsing Driver's License Data Fields](#) for more information.



*No Driver's License Parsing



Embedded Driver's License Parsing

Parsing Driver's License Data Fields (Embedded Driver's License Parsing)

To program a parsing rule:

1. Choose [Begin New Driver's License Parse Rule](#).
2. Choose any of the field options on the following pages, or [Send Keystroke \(Control Characters and Keyboard Characters\)](#).
3. After entering the entire rule, select [Save Driver's License Parse Rule](#) to save the rule.



NOTE: The scanner stores only one driver's license parsing rule in memory at a time. Saving a new rule replaces the prior rule.

4. To abort the programming sequence at any time during programming, choose [Quit Entering Driver's License Rule](#). Any previously saved rule is retained.
5. To erase a saved rule, select [Erase Driver's License Parse Rules](#).

Embedded Driver's License Parsing Criteria - Code Type

After specifying the fields and their order for the parsed driver's license, you can also apply standard ADF rules to the parsed data using the **Parsed Driver's License** criterion barcode in the Advanced Data Formatting Programmer Guide.



NOTE: Only create standard ADF rules on parsed driver's license data when configured for Embedded Driver's License Parsing.

See [Embedded Driver's License Parsing ADF Example](#) for a sample ADF rule using this code type criterion.

Driver's License Parse Rules

Choose an option to program a parsing rule.



Begin New Driver's License Parse Rule



Save Driver's License Parse Rule



Quit Entering Driver's License Rule

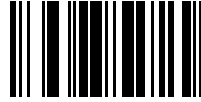

Erase Driver's License Parse Rules

Driver's License Parse Fields

These options are the supported parse fields for driver's license.

Not all IDs present data in the same format. For example, some IDs can have separate fields for first name, last name, and middle initial, while others have a single field with the entire name. Also, some IDs expire on the subject's birth date while the expiration date field only indicates the year. To present data in a consistent format, use the nine options provided in this section to return data calculated from the actual data contained in the ID barcode.



First Name



Middle Name/Initial



Last Name



Name Suffix



Name Prefix



Expiration Date



Birth Date

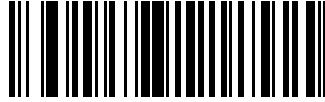

Issue Date



ID Number (Formatted)

AAMVA Parse Fields

The scanner uses the specified fields to parse out information from American Association of Motor Vehicle Administrators (AAMVA) compliant ID cards.



AAMVA Issuer ID



Full Name



Last Name



First Name



Middle Name / Initial

Driver's License Set Up



Name Suffix



Name Prefix

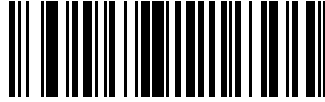

Mailing Address Line 1



Mailing Address Line 2

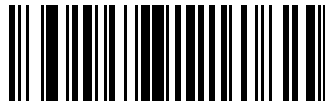

Mailing Address City



Mailing Address State

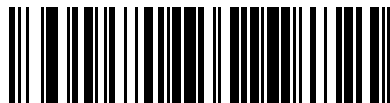

Mailing Address Postal Code



Home Address Line 1

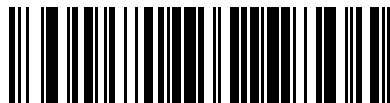

Home Address Line 2

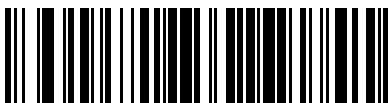

Home Address City

Driver's License Set Up



Home Address Postal Code



License Class



License Endorsements

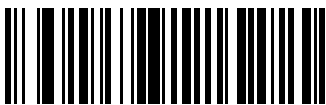

Height (Centimeters)



Weight (Kilograms)

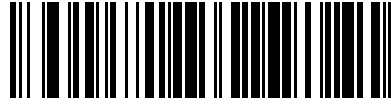

Home Address State



License ID Number



License Restrictions

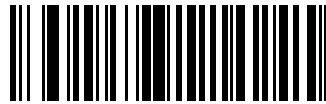

Height (Feet and/or Inches)

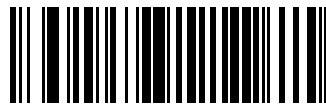

Weight (Pounds)

Driver's License Set Up



Hair Color

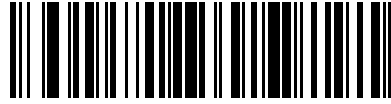

Eye Color



License Expiration Date

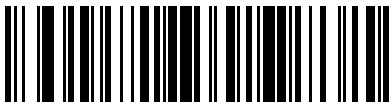

Birth Date



Gender



License Issue Date



License Issue State

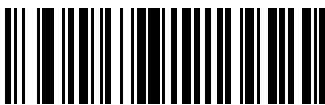

Social Security Number

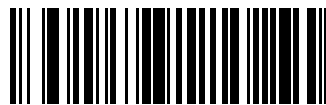

Permit Class



Permit Expiration Date

Driver's License Set Up



Permit ID Number



Permit Issue Date



Permit Restrictions



Permit Endorsements

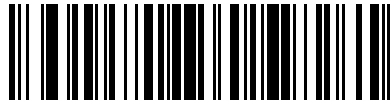

AKA Social Security Name

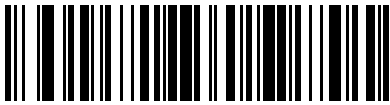

AKA Full Name



AKA Last Name



AKA First Name



AKA Middle Name / Initial

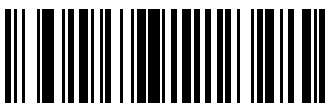

AKA Name Suffix



AKA Birth Date

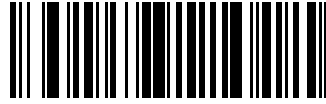

AKA Name Prefix



Issue Timestamp



Medical Codes

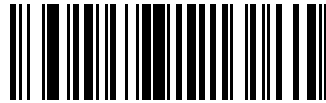

Organ Donor



Nonresident

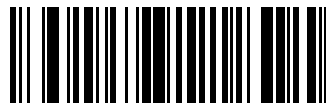

Customer ID

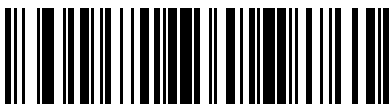

Weight Range

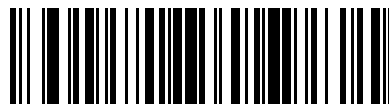

Document Discriminator



Country

Driver's License Set Up



Place of Birth



Federal Commission Codes



Audit Information



Inventory Control

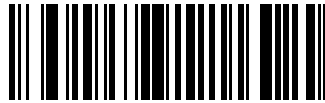

Race / Ethnicity



Std Vehicle Class

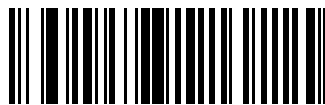

Std Endorsements



Std Restrictions



Class Description

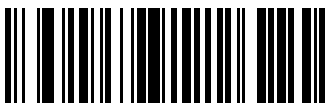

Endorsement Description



Restrictions Description



Height in Inches

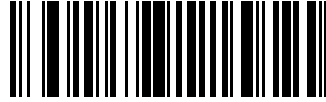

Height in Centimeters



Std Endorsements

Parser Version ID Barcode

Include this field to emit embedded parser software version identification.

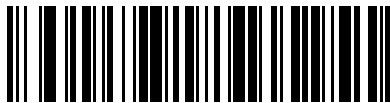

Parser Version ID

DL Parsing User Preferences

Use the following barcodes to set user preferences.

Set Default Parameter

This parameter returns all parameters to the default values.

See the default value tables in each section.



*Set All Defaults

Output Gender as M or F

Select this parameter to report the gender as M or F instead of a numeric value.



Output gender as M or F

Date Format

Use this parameter to select the date format to display.

Date fields include the following:

- CCYY = 4-digit year (CC=2-digit century [00-99], YY=2-digit year in the century [00-99])
- MM = 2-digit month [01-12]
- DD = 2-digit day of the month [00-31]

To specify a date separator, for example, a character separating each field of the date, select the Send option that corresponds to the alphanumeric character to use as the date separator immediately following the date format barcode. To select no date separator, select the No Separator DL parsing rule immediately following the date format.



*CCYYMMDD

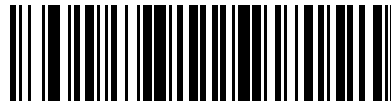

CCYYDDMM



MMDDCCYY



MMCCYYDD

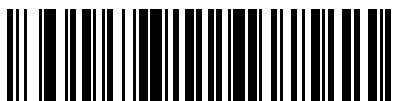

DDMMCCYY



YYMMDD



DDCCYYMM



YYDDMM

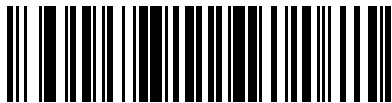

MMDDYY



MMYDD



DDMMYY



DDYYMM

No Separator

This parameter immediately follows a date format barcode to use no separator character between the date fields.



No Separator

Send Keystroke (Control Characters and Keyboard Characters)

Specify a Control Character or a Keyboard Character to send.

Control Characters

Select a Send Control parameter for the control character to send.



Send Control B

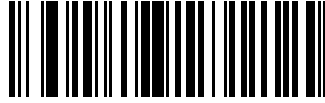

Send Control A

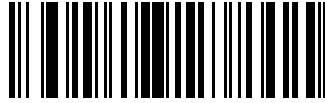

Send Control C



Send Control D

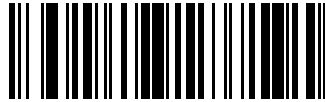

Send Control E



Send Control F



Send Control G



Send Control H



Send Control J

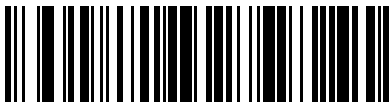

Send Control L

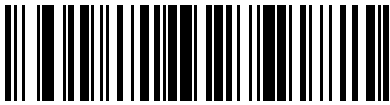

Send Control N



Send Control P

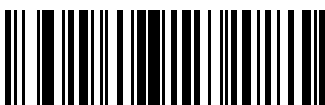

Send Control R

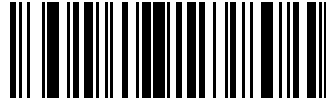

Send Control I

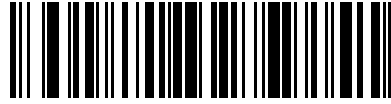

Send Control K

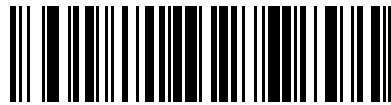

Send Control M

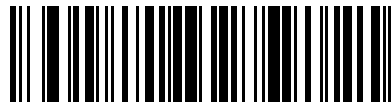

Send Control O

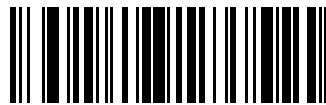

Send Control Q

Driver's License Set Up



Send Control T



Send Control V



Send Control X

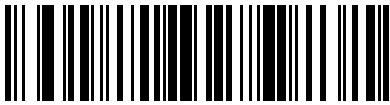

Send Control Z

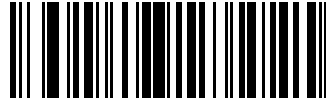

Send Control S

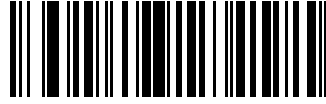

Send Control U

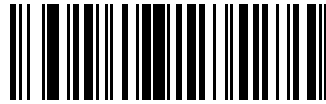

Send Control W



Send Control Y

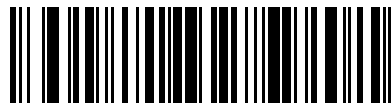

Send Control [



Send Control \

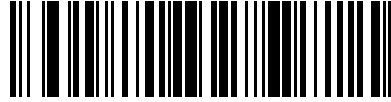

Send Control]



Send Control 6

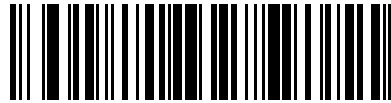

Send Control -

Keyboard Characters

Select a Send parameter for the specific keyboard characters to send.

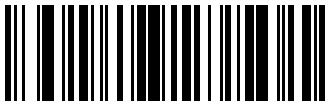

Send Space

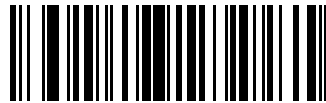

Send !



Send “



Send #

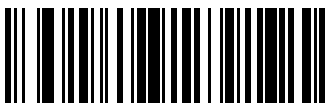

Send \$

Driver's License Set Up



Send %



Send &

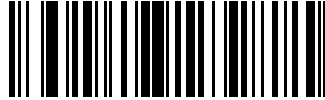

Send '



Send (/

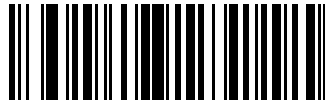

Send)

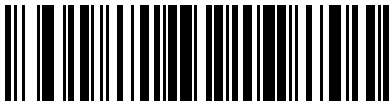

Send *

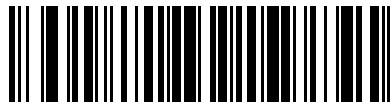

Send +



Send ,

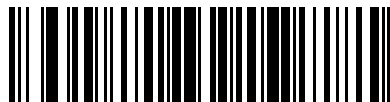

Send -

Driver's License Set Up



Send .



Send /



Send 0

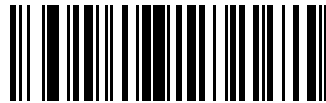

Send 1



Send 2

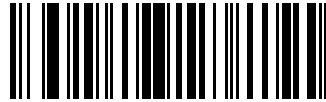

Send 3



Send 4

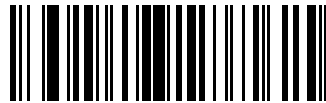

Send 5



Send 6



Send 7

Driver's License Set Up



Send 8



Send 9



Send :

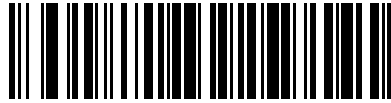

Send ;

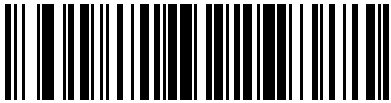

Send <

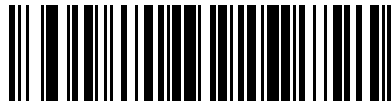

Send =

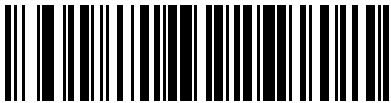

Send >

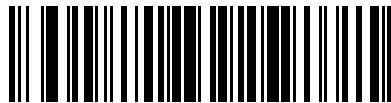

Send ?

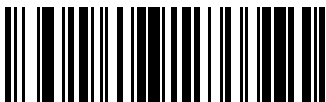

Send @



Send A

Driver's License Set Up



Send B



Send C

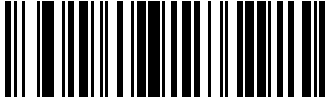

Send D

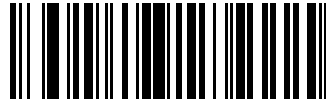

Send E

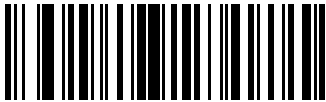

Send F

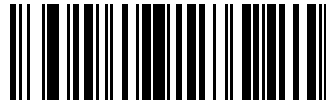

Send G



Send H



Send I



Send J

Driver's License Set Up



Send L

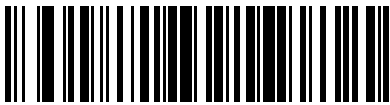

Send N



Send P

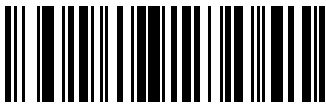

Send R

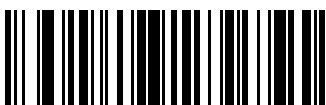

Send T

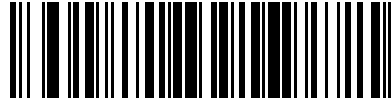

Send K

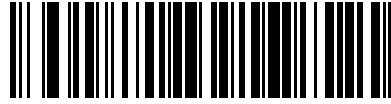

Send M

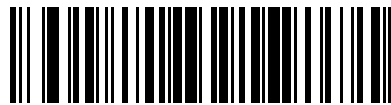

Send O

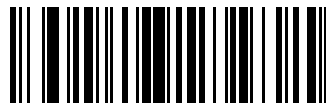

Send Q

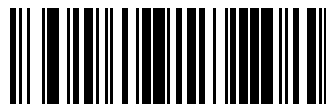

Send S

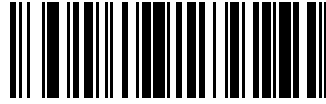

Send U



Send V

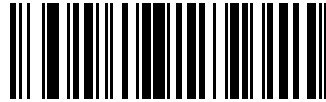

Send W



Send X

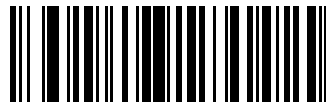

Send Y

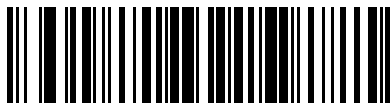

Send Z

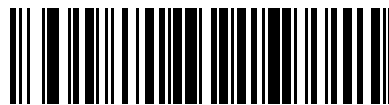

Send [

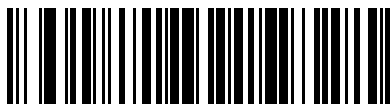

Send \

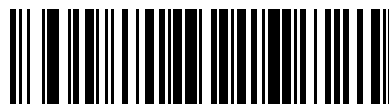

Send]

Driver's License Set Up

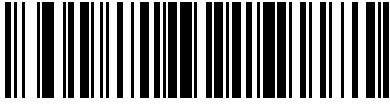

Send ^

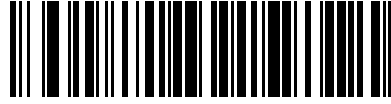

Send _



Send `

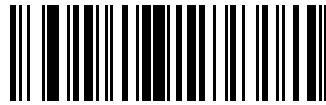

Send a



Send b

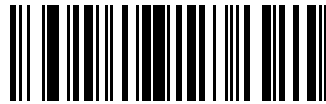

Send c



Send d

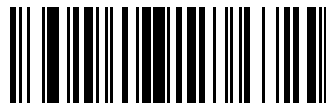

Send e

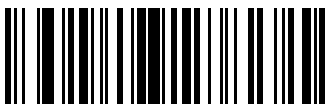

Send f



Send g

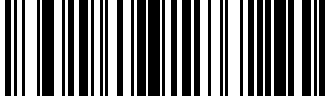

Send h

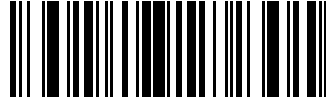

Send i

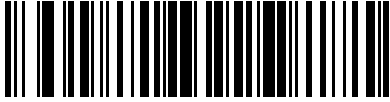

Send j

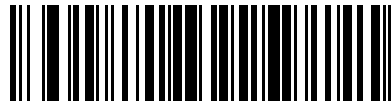

Send k

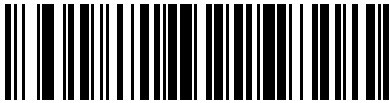

Send l

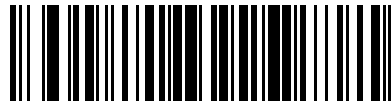

Send m

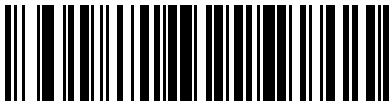

Send n

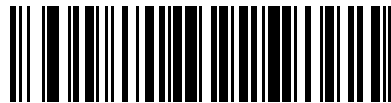

Send o

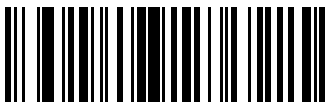

Send p



Send q

Driver's License Set Up



Send r

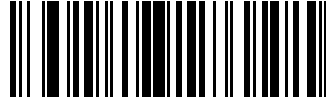

Send s



Send t

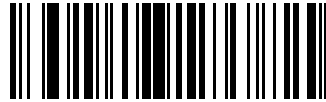

Send u

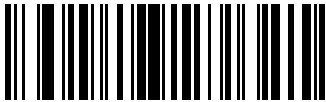

Send v

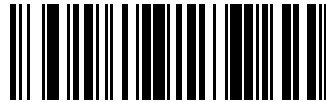

Send w



Send x

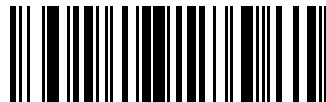

Send y

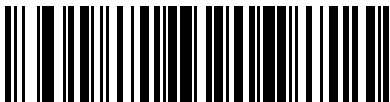

Send z

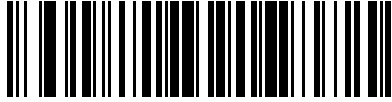

Send |



Send {



Send }

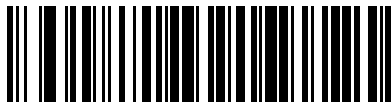

Send ~



Send Tab Key

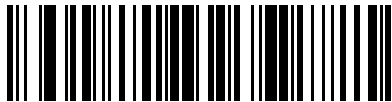

Send Enter Key

Parsing Rule Example

Follow the sequence to examine how a parsing rule is created.

Choose the parameters in sequence to program the scanner to extract and transmit:

- first, middle, and last names
- mailing address line 1
- mailing address line 2
- mailing address city
- mailing address state
- mailing address postal code
- date of birth

Then, scan a driver's license barcode.



NOTE: This example applies to RS-232. To use this example with a USB interface, enable [USB Function Key Mapping](#) to send the Enter key properly.

Driver's License Set Up

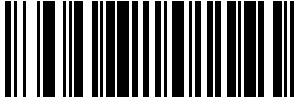

1 - Embedded Driver's License Parsing



2 - Begin New Driver's License Parse Rule



3 - First Name

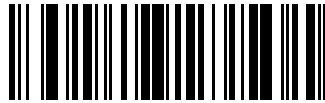

4 - Send Space



5 - Middle Name / Initial

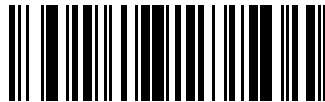

6 - Send Space



7 - Last Name

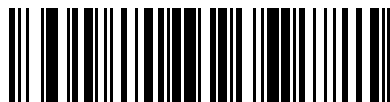

8 - Send Enter Key



9 - Mailing Address Line 1



10 - Send Space



11 - Mailing Address Line 2



12 - Send Enter Key

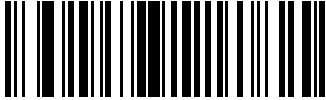

13 - Mailing Address City

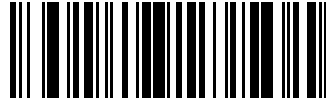

14 - Send Space



15 - Mailing Address State

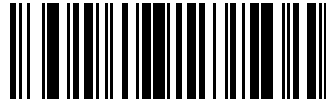

16 - Send Space



17 - Mailing Address Postal Code

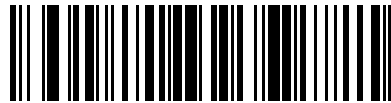

18 - Send Enter Key

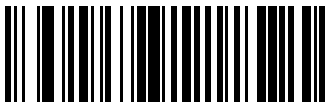

19 - Birth Date



20 - Send Enter Key



21 - Save Driver's Licence Parse Rule

Embedded Driver's License Parsing ADF Example

This example creates a parsing rule for parsed data.

The parsing rule configures the data in the following format:

```
Last Name, First Name
```

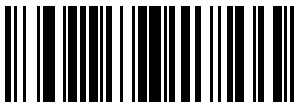

1 - Begin New Driver's License Parse Rule



2 - Last Name

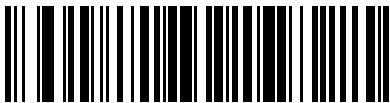

3 - Send ,

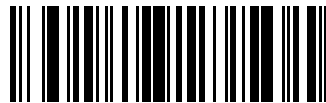

4 - Send Space



5 - First Name

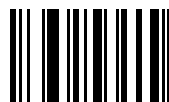

6 - Save Driver's License Parse Rule

Then, in order to limit the full name to 15 characters, create the following ADF rule:



1 - Begin New Rule



2 - Criterion: Parsed Driver's License

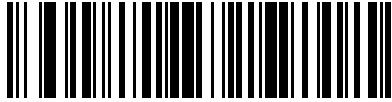

3 - Action: Send Next 15 Characters

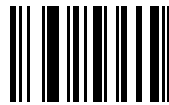

4 - Save Rule

For a license belonging to Michael Williams, the parsed data is Williams, Michael and Williams, Micha after applying the previous ADF rule.

Country Codes

This section provides instructions for programming the keyboard to interface with a USB or keyboard wedge host.

The host powers the scanner. For host setup information, see and .

To select a code page for the country keyboard type, see [Country Code Barcodes](#).

Throughout the programming barcode menus, default values are indicated with asterisks (*).

USB and Keyboard Wedge Country Keyboard Types (Country Codes)

Scan the barcode corresponding to the keyboard type. For a USB host, this setting applies only to the USB Keyboard (HID) device. If the keyboard type is not listed, see [Keypad Emulation](#) for the USB HID host. For a keyboard wedge host, see [Alternate Numeric Keypad Emulation](#).



NOTE: When changing USB country keyboard types the scanner automatically resets and issues the standard startup beep sequences.

For best results when using international keyboards, enable [USB Keyboard Emulation](#).



IMPORTANT: Some country keyboard barcode types are specific to certain Windows operating systems (i.e., XP and Windows 7 or higher). Barcodes requiring a specific Windows OS are noted in the barcode captions.

Use the French International barcode for Belgian French keyboards.

Country Code Barcodes



*US English (North American)

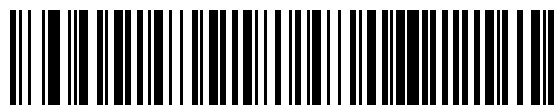

US English (Mac)

Country Codes

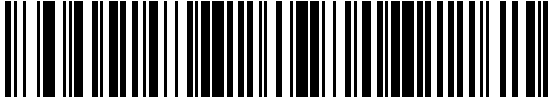

Albanian



Arabic (101)

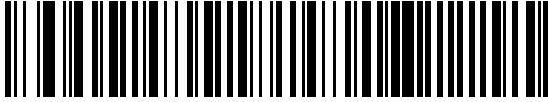

Arabic (102)



Arabic (102) AZERTY

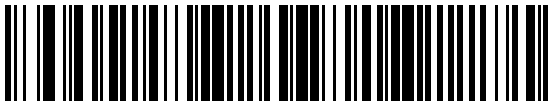

Azeri (Latin)



Azeri (Cyrillic)

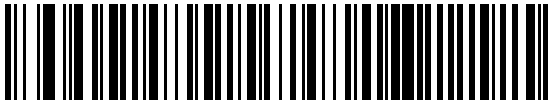

Belarusian

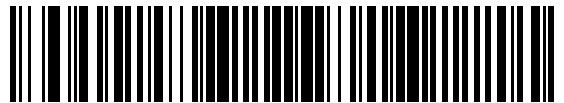

Bosnian (Latin)



Bosnian (Cyrillic)



Bulgarian (Latin)



Bulgarian Cyrillic (Typewriter) (Bulgarian -Windows XP Typewriter - Windows 7 or higher)

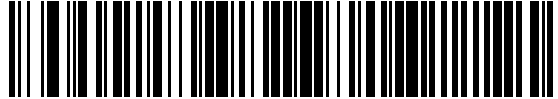

Canadian French Win7

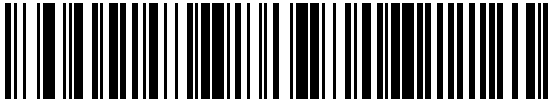

Canadian French (Legacy)

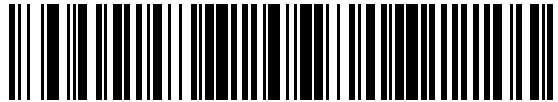

Canadian Multilingual Standard



Chinese (ASCII)



Chinese (Simplified)*

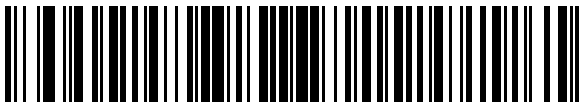

Chinese (Traditional)*

*For CJK keyboard types, see [CJK Decode Control](#).



Croatian

Country Codes

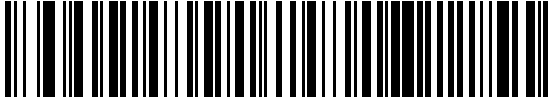

Czech



Czech (Programmer)



Czech (QWERTY)



Danish

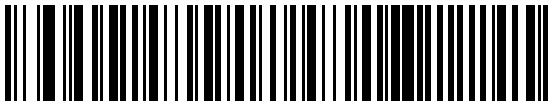

Dutch (Netherlands)

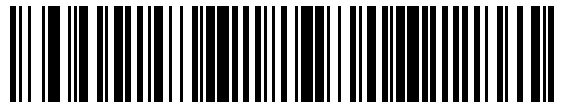

Estonian

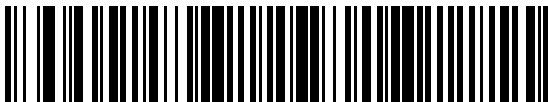

Faeroese

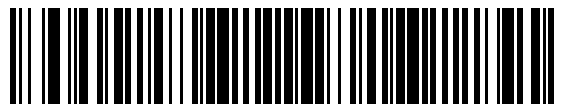

Finnish



French (France)



French (Canada) 95/98



French International (Belgian French)



French (Canada) 2000/XP*

*Note that there is also a country code barcode for Canadian Multilingual Standard. Be sure to select the appropriate barcode for your host system.

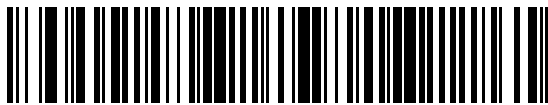

Galician



German

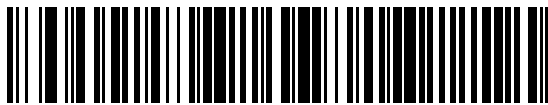

Greek Latin

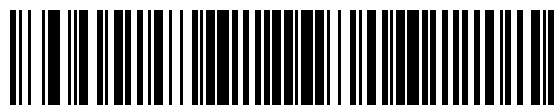

Greek (220) Latin

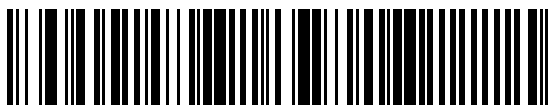

Greek (319) Latin



Greek

Country Codes

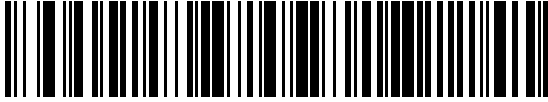

Greek (220)

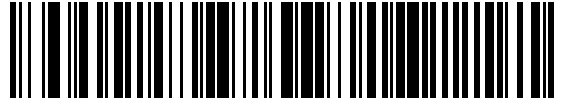

Greek (319)

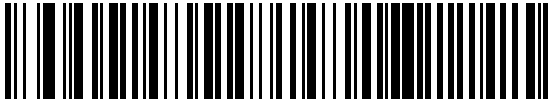

Greek Polytonic

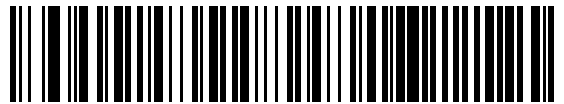

Hebrew Israel

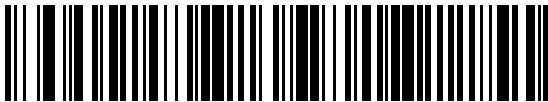

Hungarian

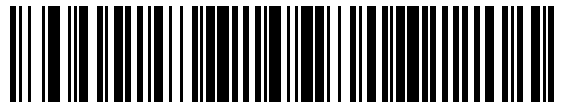

Hungarian_101KEY

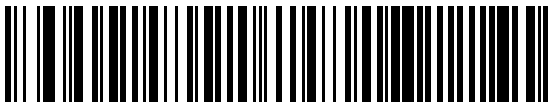

Icelandic



Irish



Italian

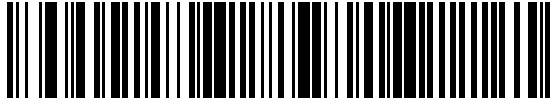

Japanese (ASCII)



Italian (142)



Japanese (SHIFT-JIS)*

*For CJK keyboard types, see [CJK Decode Control](#).

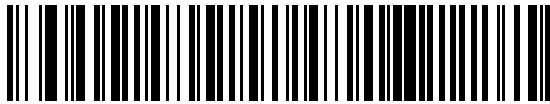

Kazakh



Korean (ASCII)

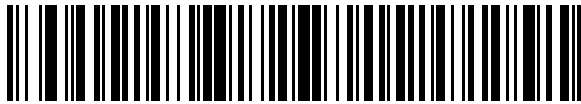

Korean (Hangul)*

*For CJK keyboard types, see [CJK Decode Control](#).

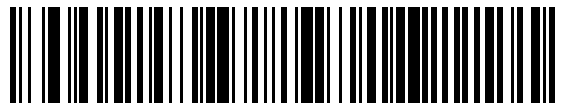

Kyrgyz

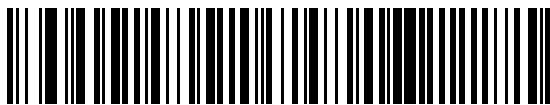

Latin American



Latvian

Country Codes

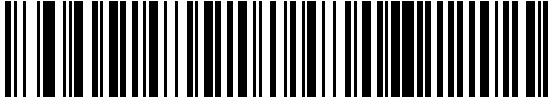

Latvian (QWERTY)



Lithuanian

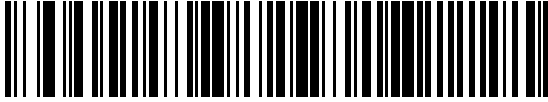

Lithuanian (IBM)

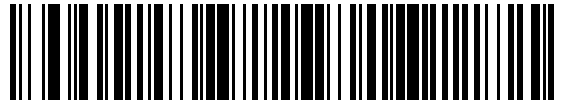

Macedonian (FYROM)

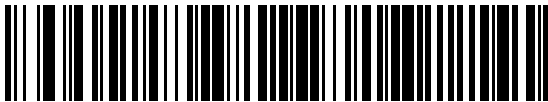

Maltese_47KEY

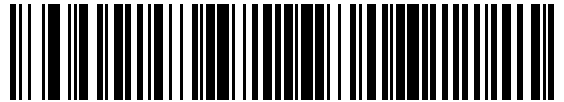

Mongolian



Norwegian

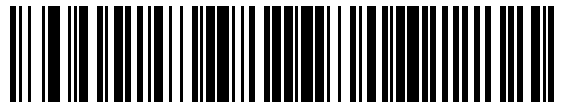

Polish (214)

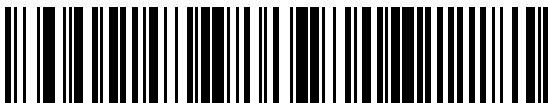

Polish (Programmer)

Country Codes



Portuguese (Brazilian ABNT)

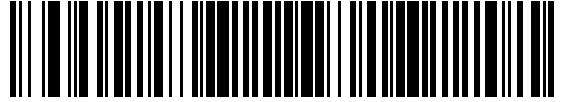

Portuguese (Brazil) (Windows XP)

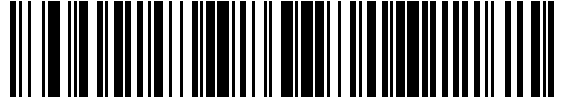

Portuguese (Brazilian ABNT2)



Portuguese (Portugal)

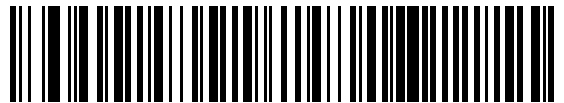

Romanian (Windows XP)

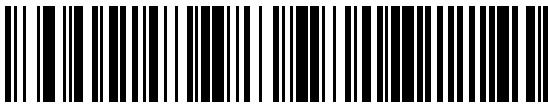

Romanian (Legacy) (Windows 7 or higher)

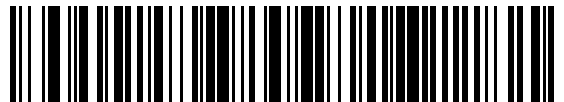

Romanian (Standard) (Windows 7 or higher)

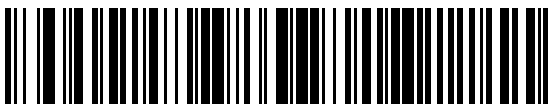

Romanian (Programmer) (Windows 7 or higher)

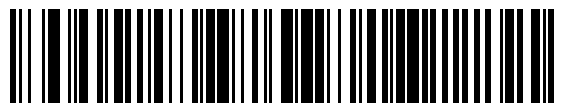

Russian



Russian (Typewriter)

Country Codes



Serbian (Cyrillic)



Serbian (Latin)

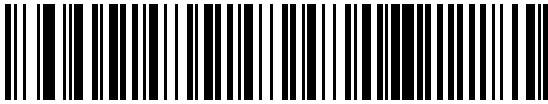

Slovak (QWERTY)



Slovak



Spanish



Slovenian

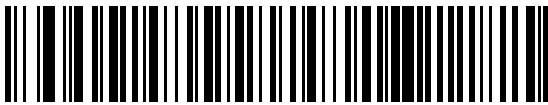

Swedish

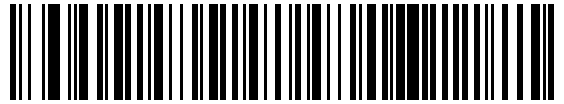

Spanish (Variation)

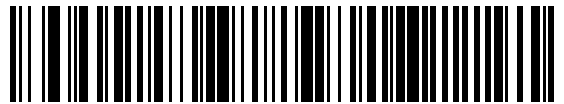

Swiss French

Country Codes

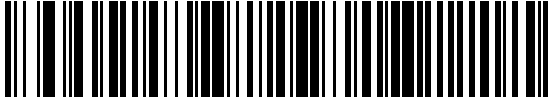

Swiss German



Tatar

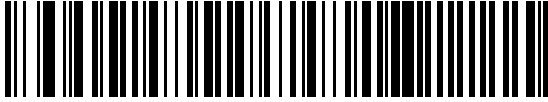

Thai (Kedmanee)

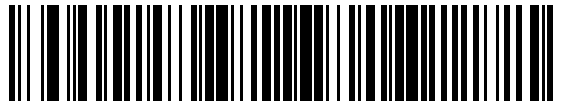

Turkish F

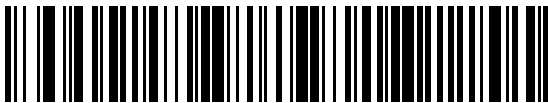

Turkish Q

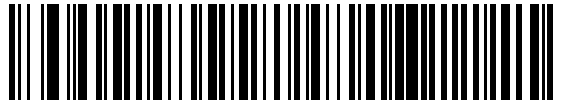

UK English

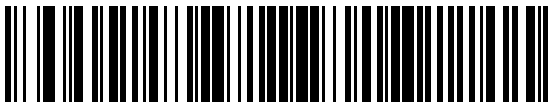

Ukrainian

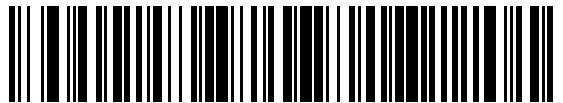

US Dvorak

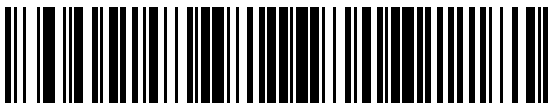

US Dvorak Left

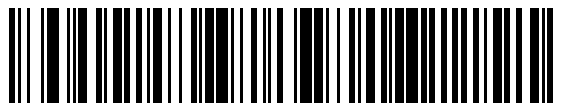

US Dvorak Right

Country Codes



US International

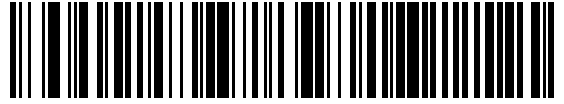

Uzbek

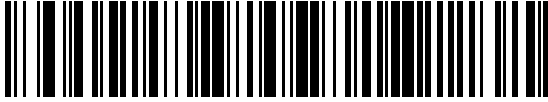

Vietnamese

Country Code Pages

This section provides barcodes for selecting code pages for the country keyboard type selected in Country Codes.

If the default code page in [Country Code Pages](#) is appropriate for your selected country keyboard type, you do not need to scan a country code page barcode.



NOTE: ADF rules can also specify a code page based on the symbology and other ADF criteria. Refer to the Advanced Data Formatting Programmer Guide.

Country Code Page Defaults

The table in this section lists the code page default for each country keyboard.

Table 32 Country Code Page Defaults

Country Keyboard	Code Page Default
US English (North American)	Windows 1252
US English (Mac)	Mac CP10000
Albanian	Windows 1250
Arabic 101	Windows 1256
Arabic 102	Windows 1256
Arabic 102 AZERTY	Windows 1256
Azeri Latin	Windows 1254
Azeri Cyrillic	Windows 1251
Belarusian	Windows 1251
Bosnian Latin	Windows 1250
Bosnian Cyrillic	Windows 1251
Bulgarian Latin	Windows 1250
Bulgarian Cyrillic	Windows 1251
Canadian French Win7	Windows 1252
Canadian French (Legacy)	Windows 1252
Canadian Multilingual	Windows 1252

Table 32 Country Code Page Defaults (Continued)

Country Keyboard	Code Page Default
Croatian	Windows 1250
Chinese ASCII	Windows 1252
Chinese (Simplified)	Windows 936, GBK
Chinese (Traditional)	Windows 950, Big5
Czech	Windows 1250
Czech Programmers	Windows 1250
Czech QWERTY	Windows 1250
Danish	Windows 1252
Dutch Netherland	Windows 1252
Estonian	Windows 1257
Faeroese	Windows 1252
Finnish	Windows 1252
French (France)	Windows 1252
French (Canada) 95/98	Windows 1252
French (Canada) 2000/XP	Windows 1252
French International (Belgian French)	Windows 1252
Galician	Windows 1252
German	Windows 1252
Greek Latin	Windows 1252
Greek220 Latin	Windows 1253
Greek319 Latin	Windows 1252
Greek	Windows 1253
Greek220	Windows 1253
Greek319	Windows 1253
Greek Polytonic	Windows 1253
Hebrew Israel	Windows 1255
Hungarian	Windows 1250
Hungarian_101KEY	Windows 1250
Icelandic	Windows 1252
Irish	Windows 1252
Italian	Windows 1252
Italian_142	Windows 1252
Japanese ASCII	Windows 1252

Table 32 Country Code Page Defaults (Continued)

Country Keyboard	Code Page Default
Japanese (Shift-JIS)	Windows 932, Shift-JIS
Kazakh	Windows 1251
Korean ASCII	Windows 1252
Korean (Hangul)	Windows 949, Hangul
Kyrgyz Cyrillic	Windows 1251
Latin America	Windows 1252
Latvian	Windows 1257
Latvian QWERTY	Windows 1257
Lithuanian	Windows 1257
Lithuanian_IBM	Windows 1257
Macedonian -FYROM	Windows 1251
Maltese_47KEY	Windows 1252
Mongolian-Cyrillic	Windows 1251
Norwegian	Windows 1252
Polish_214	Windows 1250
Polish Programmer	Windows 1250
Portuguese Brazil	Windows 1252
Portuguese Brazilian ABNT	Windows 1252
Portuguese Brazilian ABNT2	Windows 1252
Portuguese Portugal	Windows 1252
Romanian	Windows 1250
Romanian Legacy	Windows 1250
Romanian Standard	Windows 1250
Romanian Programmer	Windows 1250
Russian	Windows 1251
Russian Typewriter	Windows 1251
Serbian Latin	Windows 1250
Serbian Cyrillic	Windows 1251
Slovak	Windows 1250
Slovak QWERTY	Windows 1250
Slovenian	Windows 1250
Spanish	Windows 1252
Spanish Variation	Windows 1252

Table 32 Country Code Page Defaults (Continued)

Country Keyboard	Code Page Default
Swedish	Windows 1252
Swiss French	Windows 1252
Swiss German	Windows 1252
Tatar	Windows 1251
Thai-Kedmanee	Windows 874
Turkish F	Windows 1254
Turkish Q	Windows 1254
Ukrainian	Windows 1251
United Kingdom	Windows 1252
United States	Windows 1252
US Dvorak	Windows 1252
US Dvorak Left Hand	Windows 1252
US Dvorak Right Hand	Windows 1252
US International	Windows 1252
Uzbek Cyrillic	Windows 1251
Vietnamese	Windows 1258

Country Code Page Barcodes

Parameter # 961

Scan the barcode corresponding to the country keyboard code page.

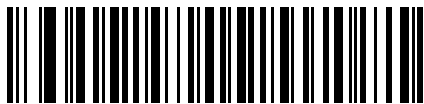

Windows 1250 Latin 2, Central European

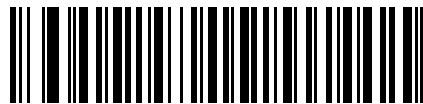

Windows 1251 Cyrillic, Slavic



Windows 1252 Latin 1, Western European

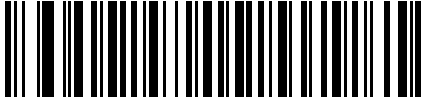

Windows 1254 Latin 5, Turkish

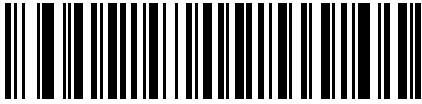

Windows 1256 Arabic

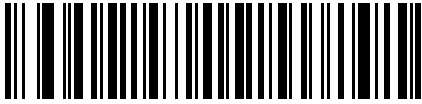

Windows 1258 Vietnamese

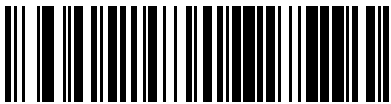

Windows 20866 Cyrillic KOI8-R

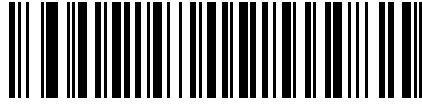

Windows 1253 Greek

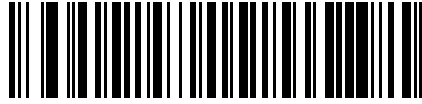

Windows 1255 Hebrew

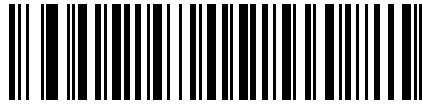

Windows 1257 Baltic

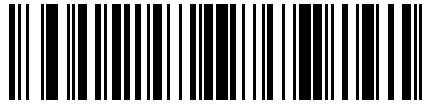

Windows 874 Thai

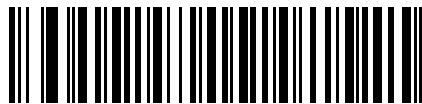

Windows 932 Japanese Shift-JIS



Windows 936 Simplified Chinese GBK



Windows 54936 Simplified Chinese GB18030



Windows 949 Korean Hangul

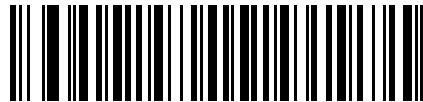

Windows 950 Traditional Chinese Big5

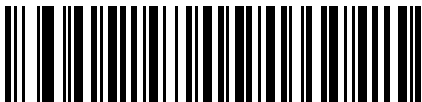

MS-DOS 437 Latin US

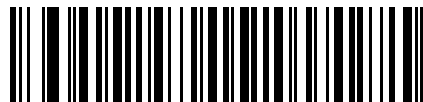

MS-DOS 737 Greek

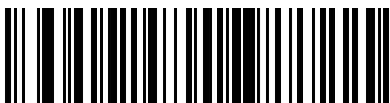

MS-DOS 775 Baltic



MS-DOS 850 Latin 1



MS-DOS 852 Latin 2

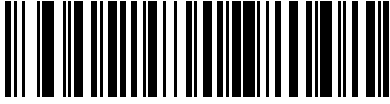

MS-DOS 857 Turkish



MS-DOS 861 Icelandic



MS-DOS 863 French Canada



MS-DOS 866 Cyrillic



MS-DOS 855 Cyrillic

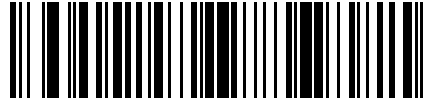

MS-DOS 860 Portuguese

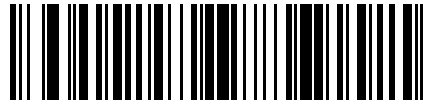

MS-DOS 862 Hebrew

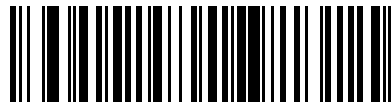

MS-DOS 865 Nordic

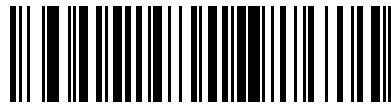

MS-DOS 869 Greek 2



ISO 8859-1 Latin 1, Western European



ISO 8859-2 Latin 2, Central European



ISO 8859-3 Latin 3, South European

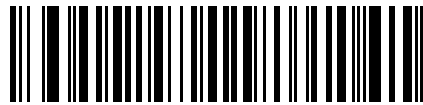

ISO 8859-4 Latin 4, North European

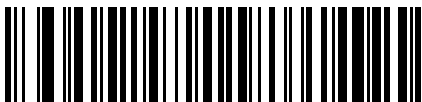

ISO 8859-5 Cyrillic

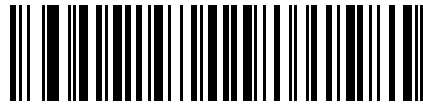

ISO 8859-6 Arabic

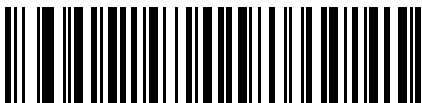

ISO 8859-7 Greek

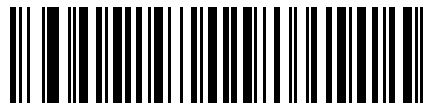

ISO 8859-8 Hebrew



ISO 8859-9 Latin 5, Turkish



ISO 8859-10 Latin 6, Nordic

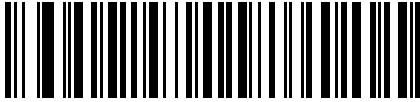

ISO 8859-11 Thai



ISO 8859-13 Latin 7, Baltic

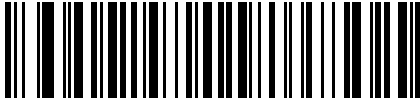

ISO 8859-14 Latin 8, Celtic

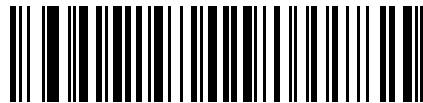

ISO 8859-15 Latin 9

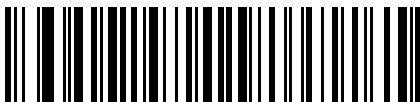

ISO 8859-16 Latin 10, South-Eastern European

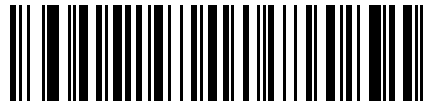

UTF-8



UTF-16LE UTF-16 Little Endian



UTF-16BE UTF-16 Big Endian



Mac CP10000 Roman

CJK Decode Control

This appendix describes control parameters for CJK (Chinese, Japanese, Korean) barcode decode through USB HID Keyboard Emulation mode.



NOTE: Because ADF does not support CJK character processing, there is no format manipulation for CJK output.

CJK Control Parameters

Unicode Output Control

Parameter # 973

For a Unicode encoded CJK barcode, select one of the following options for Unicode output:

- Universal Output to Unicode and MBCS Application - This default method applies to Unicode and MBCS expected applications, such as MS Word and Notepad on a Windows host.



NOTE: To support Unicode universal output, set up the registry table for the Windows host. See [Unicode/CJD Decode Setup with Windows Host](#).

- Output to Unicode Application Only - This method applies only to Unicode expected applications, such as MS Word and WordPad, but not Notepad.

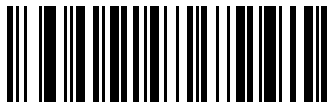

*Universal Output (0)



Unicode Application Only (1)

CJK Output Method to Windows Host

Parameter # 972

For a national standard encoded CJK barcode, select one of the following options for CJK output to a Windows host:

- **Universal CJK Output** - This is the default universal CJK output method for US English IME or Chinese/Japanese/Korean ASCII IME on a Windows host. This method converts CJK characters to Unicode and emulates the characters when transmitting to the host. Use the [Unicode Output Control](#) parameter to control Unicode output.



NOTE: To support universal CJK output, set up the registry table for the Windows host. See [Unicode/CJK Decode Setup Windows Host](#).

- **Other options for CJK output** - With the following methods, the scanner sends the CJK character hexadecimal internal code (Nei Ma) value to the host, or converts the CJK character to Unicode and sends the hexadecimal Unicode value to the host. When using these methods, the Windows host must select the corresponding IME to accept the CJK character. See [Unicode/CJK Decode Setup Windows Host](#).
- **Japanese Unicode Output**
- **Simplified Chinese GBK Code Output**
- **Simplified Chinese Unicode Output**
- **Korean Unicode Code Output**
- **Traditional Chinese Big5 Code Output** (Windows XP)
- **Traditional Chinese Big5 Code Output** (Windows 7)
- **Traditional Chinese Unicode Code Output** (Windows XP)
- **Traditional Chinese Unicode Code Output** (Windows 7)



NOTE: The Unicode emulate output method depends on the host system (Windows XP or Windows 7).

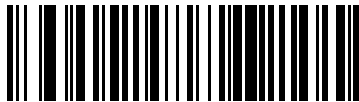

*Universal CJK Output (0)

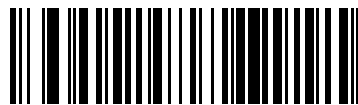

Japanese Unicode Output (34)

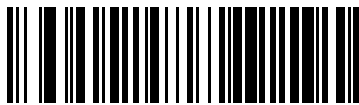

Chinese (Simplified) GBK Output (1)



Chinese (Simplified) Unicode Output (2)



Korean Unicode Output (50)

(for Korean Unicode Output, select Simplified Chinese Unicode IME on the Windows host)

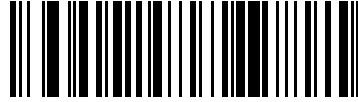

Chinese (Traditional) Big5 Output (Windows XP) (1)



Chinese (Traditional) Big5 Output (Windows 7) (19)

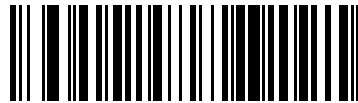

Chinese (Traditional) Unicode Output (Windows XP) (18)

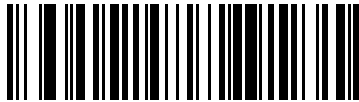

Chinese (Traditional) Unicode Output (Windows 7) (20)

Non-CJK UTF Barcode Output

Parameter # 960

Some country keyboard type layouts contain characters that do not exist in the default code page (see below). Although the default code page can not encode these characters in a barcode, they can be encoded in the UTF-8 barcode. Scan the following barcode to output the Unicode values by emulation mode.



NOTE: Use this special country keyboard type to decode the non-CJK UTF-8 barcode. After decoding, re-configure the scanner to use the original country keyboard type.

Use US English IME on Windows. See [Unicode Output Control](#).



Non-CJK UTF-8 Emulation Output

Missing Characters for Country Keyboard Type: Tatar, Uzbek, Mongolian, Kyrgyz, Kazakh and Azeri

Default code page: CP1251

Missing characters:

F	F
X	X
K	K
h	h
ø	Ø
ə	Ə
Y	Y
H	H
Ж	Ж
ƒ	
H	H
ƴ	ƴ
K	K
ч	ч
к	к

Missing Characters for Country Keyboard Type: Romanian (Standard)

Default code page: CP1250

Missing characters:

ș	Ș
ț	Ț

Missing Characters for Country Keyboard Type: Portuguese-Brazilian (ABNT), Portuguese-Brazilian (ABNT2)

Default code page: CP1252

Missing character: €

Missing Characters for Country Keyboard Type: Azeri-Latin

Default code page: CP1254

Missing characters: ə, Ə

Unicode/CJK Decode Setup with Windows Host

This section describes how to set up CJK decode with a Windows host.

Setting Up the Windows Registry Table for Unicode Universal Output

To support the Unicode universal output method, set up the Windows host registry table as follows:

1. Select **Start > Run > regedt32** to start the registry editor.

- Under **HKEY_Current_User\Control Panel\Input Method**, set **EnableHexNumpad** to **1** as follows:

```
[HKEY_CURRENT_USER\Control Panel\Input Method]
```

```
"EnableHexNumpad" = "1"
```

If this key does not exist, add it as type **REG_SZ** (string value).

- Reboot the computer to implement the registry change.

Adding CJK IME on Windows

To add the desired CJK input language:

- Click **Start > Control Panel**.
- If the Control Panel opens in category view, select **Switch to Classic View** in the top left corner.
- Select **Regional and Language Options**.
- Click the **Language** tab.
- Under **Supplemental Language Support**, select the **Install Files for East Asian Languages** check box if not already selected, and click **Apply**. This may require a Windows installation CD to install the required files. This step ensures that the East Asian Languages (CJK) are available.
- Under **Text Services and Input Language**, click **Details**.
- Under **Installed Services**, click **Add**.
- In the **Add Input Language** dialog box, choose the CJK input language and keyboard layout or Input Method Editor (IME) to add.
- Click **OK** twice. The language indicator appears in the system tray (at bottom right corner of the desktop by default). To switch between input languages (keyboard languages) select the language indicator in the system tray.
- Select the language indicator in the system tray to select the desired country keyboard type.
- Verify that the characters displayed on each country's keyboard appear.

Selecting the Simplified Chinese Input Method on the Host

To select the Simplified Chinese input method:

- Select Unicode/GBK input on Windows XP: **Chinese (Simplified) - NeiMa**, then click the input bar to select **Unicode** or **GBK NeiMa** input.

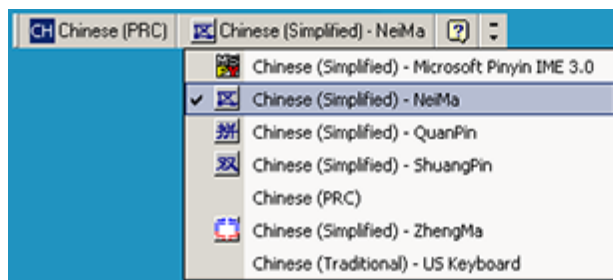

Or



- Select Unicode/GBK input on Windows 7: **Chinese (Simplified) - Microsoft Pinyin New Experience Input Style**, then select **Tool Menu > Secondary Inputs > Unicode Input** or **GB Code Input**.

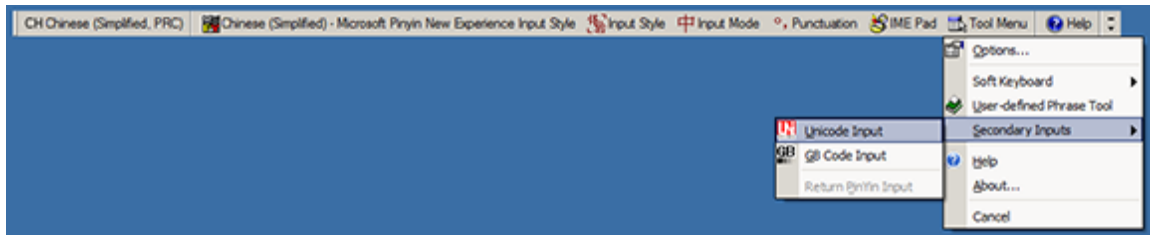

Selecting the Traditional Chinese Input Method on the Host

To select the Traditional Chinese input method:

- Select Unicode input on Windows XP: **Chinese (Traditional) - Unicode**

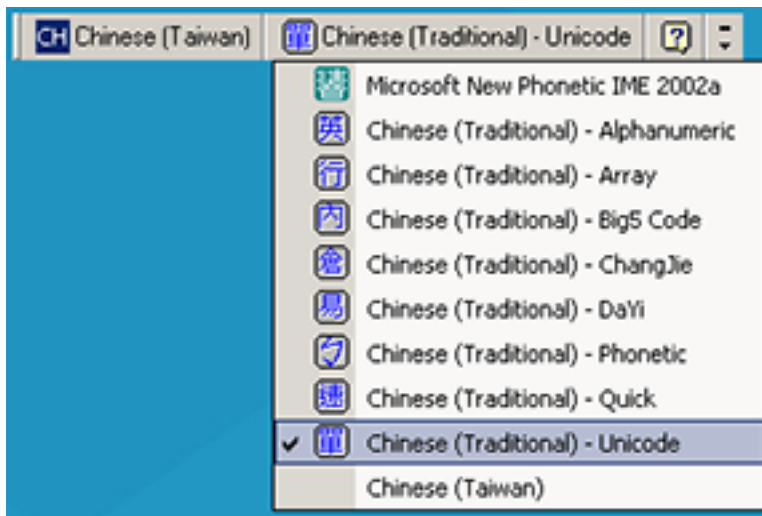

- Select Big5 input on Windows XP: **Chinese (Traditional) - Big5 Code**

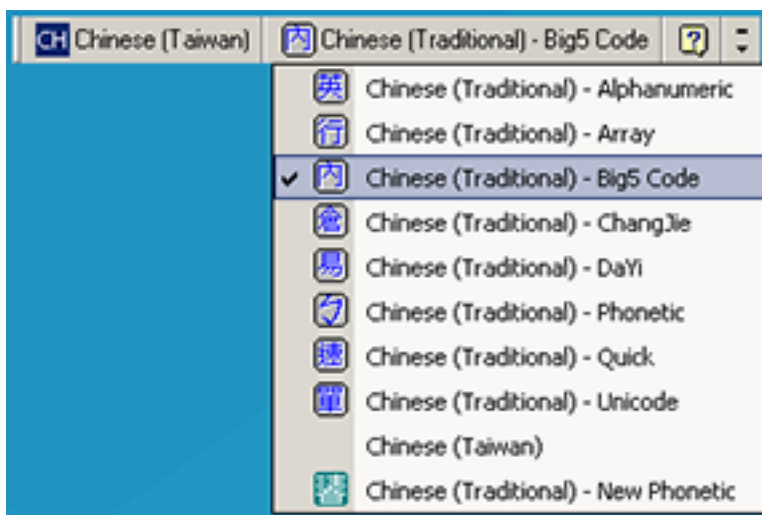

- Select Unicode/Big5 input on Windows 7: **Chinese (Traditional) - New Quick**. This option support both Unicode and Big5 input.

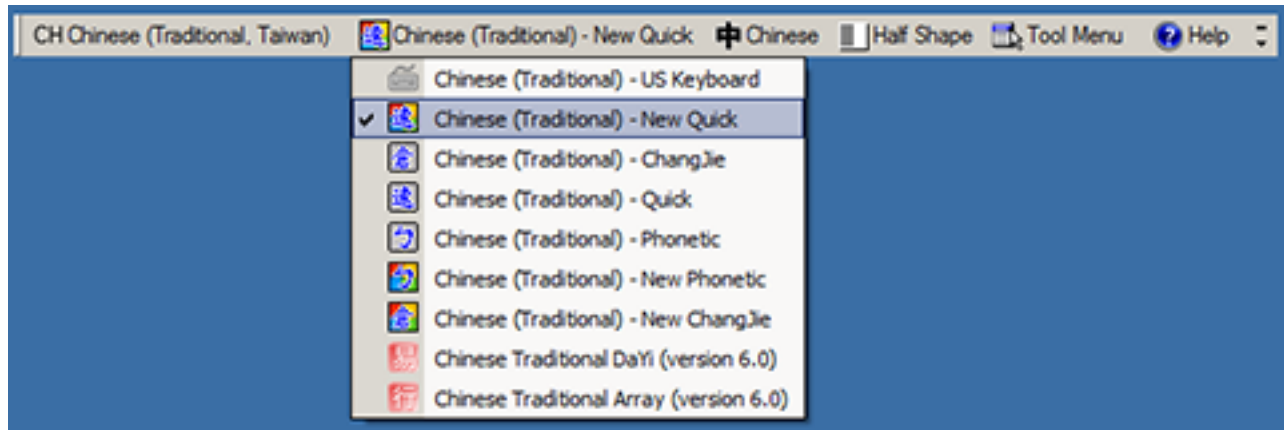

Programming Reference

This section provides symbol and AIM code identifiers.

Symbol Code Identifiers

Table 33 Symbol Code Characters

Code Character	Code Type
A	UPC-A, UPC-E, UPC-E1, EAN-8, EAN-13
B	Code 39, Code 32
C	Codabar
D	Code 128, ISBT 128, ISBT 128 Concatenated
E	Code 93
F	Interleaved 2 of 5
G	Discrete 2 of 5, or Discrete 2 of 5 IATA
H	Code 11
J	MSI
K	GS1-128
L	Bookland EAN
M	Trioptic Code 39
N	Coupon Code
R	GS1 DataBar Family
S	Matrix 2 of 5
T	UCC Composite, TLC 39
U	Chinese 2 of 5
X	ISSN EAN, PDF417, Macro PDF417, Micro PDF417
z	Aztec, Aztec Rune
P00	Data Matrix
P01	QR Code, MicroQR

Table 33 Symbol Code Characters (Continued)

Code Character	Code Type
P02	Maxicode
P03	US Postnet
P04	US Planet
P05	Japan Postal
P06	UK Postal
P08	Netherlands KIX Code
P09	Australia Post
P0A	USPS 4CB/One Code/Intelligent Mail
P0B	UPU FICS Postal
P0C	Mailmark
P0D	Grid Matrix
P0G	GS1 Data Matrix
P0H	Han Xin
P0Q	GS1 QR
P0X	Signature Capture

AIM Code Identifiers

Each AIM Code Identifier contains the three-character string]cm where:

] = Flag Character (ASCII 93)

c = Code Character (see table below)

m = Modifier Character (see table below)

Table 34 AIM Code Characters

Code Character	Code Type
A	Code 39, Code 39 Full ASCII, Code 32
C	Code 128, ISBT 128, ISBT 128 Concatenated, GS1-128, Coupon (Code 128 portion)
d	Data Matrix, GS1 Data Matrix
E	UPC/EAN, Coupon (UPC portion)
e	GS1 DataBar Family

Table 34 AIM Code Characters (Continued)

Code Character	Code Type
F	Codabar
G	Code 93
g	Grid Matrix
H	Code 11
h	Han Xin
I	Interleaved 2 of 5
L	PDF417, Macro PDF417, Micro PDF417
L2	TLC 39
M	MSI
Q	QR Code, MicroQR, GS1 QR
S	Discrete 2 of 5, IATA 2 of 5
U	Maxicode
z	Aztec, Aztec Rune
X	Bookland EAN, ISSN EAN, Trioptic Code 39, Chinese 2 of 5, Matrix 2 of 5, Korean 3 of 5, US Postnet, US Planet, UK Postal, Japan Postal, Australia Post, Netherlands KIX Code, USPS 4CB/One Code/ Intelligent Mail, UPU FICS Postal, Mailmark, Signature Capture

The modifier character is the sum of the applicable option values based on the following table.

Table 35 Modifier Characters

Code Type	Option Value	Option
Code 39	0	No check character or Full ASCII processing.
	1	Reader has checked one check character.
	3	Reader has checked and stripped check character.
	4	Reader has performed Full ASCII character conversion.
	5	Reader has performed Full ASCII character conversion and checked one check character.
	7	Reader has performed Full ASCII character conversion and checked and stripped check character.
	Example: A Full ASCII barcode with check character W, A+I+MI+DW, is transmitted as JA7AIMID where 7 = (3+4).	
Trioptic Code 39	0	No option specified at this time. Always transmit 0.
	Example: A Trioptic barcode 412356 is transmitted as JX0412356	
Code 128	0	Standard data packet, no Function code 1 in first symbol position.
	1	Function code 1 in first symbol character position.
	2	Function code 1 in second symbol character position.

Table 35 Modifier Characters (Continued)

Code Type	Option Value	Option
		Example: A Code (EAN) 128 barcode with Function 1 character FNC1 in the first position, AIMID is transmitted as]C1AIMID
I 2 of 5	0	No check digit processing.
	1	Reader has validated check digit.
	3	Reader has validated and stripped check digit.
		Example: An I 2 of 5 barcode without check digit, 4123, is transmitted as]I04123
Codabar	0	No check digit processing.
	1	Reader has checked check digit.
	3	Reader has stripped check digit before transmission.
		Example: A Codabar barcode without check digit, 4123, is transmitted as]F04123
Code 93	0	No options specified at this time. Always transmit 0.
		Example: A Code 93 barcode 012345678905 is transmitted as]G0012345678905
MSI	0	Check digits are sent.
	1	No check digit is sent.
		Example: An MSI barcode 4123, with a single check digit checked, is transmitted as]M14123
D 2 of 5	0	No options specified at this time. Always transmit 0.
		Example: A D 2 of 5 barcode 4123, is transmitted as]S04123
UPC/EAN	0	Standard data packet in full EAN format, i.e., 13 digits for UPC-A, UPC-E, and EAN-13 (not including supplemental data).
	1	Two digit supplemental data only.
	2	Five digit supplemental data only.
	3	Combined data packet comprising 13 digits from EAN-13, UPC-A or UPC-E symbol and 2 or 5 digits from supplemental symbol.
	4	EAN-8 data packet.
		Example: A UPC-A barcode 012345678905 is transmitted as]E0012345678905
Bookland EAN	0	No options specified at this time. Always transmit 0.
		Example: A Bookland EAN barcode 123456789X is transmitted as]X0123456789X
ISSN EAN	0	No options specified at this time. Always transmit 0.
		Example: An ISSN EAN barcode 123456789X is transmitted as]X0123456789X
Code 11	0	Single check digit
	1	Two check digits
	3	Check characters validated but not transmitted.

Table 35 Modifier Characters (Continued)

Code Type	Option Value	Option
GS1 DataBar Family		No option specified at this time. Always transmit 0. GS1 DataBar Omnidirectional and GS1 DataBar Limited transmit with an Application Identifier "01". Note: In GS1-128 emulation mode, GS1 DataBar is transmitted using Code 128 rules (i.e.,]C1).
		Example: A GS1 DataBar Omnidirectional barcode 0110012345678902 is transmitted as]e00110012345678902.
EAN.UCC Composites (GS1 DataBar, GS1-128, 2D portion of UPC composite)		Native mode transmission.  NOTE: UPC portion of composite is transmitted using UPC rules.
	0	Standard data packet.
	1	Data packet containing the data following an encoded symbol separator character.
	2	Data packet containing the data following an escape mechanism character. The data packet does not support the ECI protocol.
	3	Data packet containing the data following an escape mechanism character. The data packet supports the ECI protocol.
		GS1-128 emulation Note: UPC portion of composite is transmitted using UPC rules.
	1	Data packet is a GS1-128 symbol (i.e., data is preceded with]JC1).
PDF417, Micro PDF417	0	Reader set to conform to protocol defined in 1994 PDF417 symbology specifications. Note: When this option is transmitted, the receiver cannot reliably determine whether ECIs have been invoked or whether data byte 92DEC has been doubled in transmission.
	1	Reader set to follow the ECI protocol (Extended Channel Interpretation). All data characters 92DEC are doubled.
	2	Reader set for Basic Channel operation (no escape character transmission protocol). Data characters 92DEC are not doubled. Note: When decoders are set to this mode, unbuffered Macro symbols and symbols requiring the decoder to convey ECI escape sequences cannot be transmitted.
	3	The barcode contains a GS1-128 symbol, and the first codeword is 903-907, 912, 914, 915.
	4	The barcode contains a GS1-128 symbol, and the first codeword is in the range 908-909.
	5	The barcode contains a GS1-128 symbol, and the first codeword is in the range 910-911.
		Example: A PDF417 barcode ABCD, with no transmission protocol enabled, is transmitted as]L2ABCD.
Data Matrix	0	ECC 000-140, not supported.
	1	ECC 200.
	2	ECC 200, FNC1 in first or fifth position.
	3	ECC 200, FNC1 in second or sixth position.

Table 35 Modifier Characters (Continued)

Code Type	Option Value	Option
	4	ECC 200, ECI protocol implemented.
	5	ECC 200, FNC1 in first or fifth position, ECI protocol implemented.
	6	ECC 200, FNC1 in second or sixth position, ECI protocol implemented.
GS1 Data Matrix	2	ECC 200, FNC1 in first or fifth position.
MaxiCode	0	Symbol in Mode 4 or 5.
	1	Symbol in Mode 2 or 3.
	2	Symbol in Mode 4 or 5, ECI protocol implemented.
	3	Symbol in Mode 2 or 3, ECI protocol implemented in secondary message.
QR Code	0	Model 1 symbol.
	1	Model 2 / MicroQR symbol, ECI protocol not implemented.
	2	Model 2 symbol, ECI protocol implemented.
	3	Model 2 symbol, ECI protocol not implemented, FNC1 implied in first position.
	4	Model 2 symbol, ECI protocol implemented, FNC1 implied in first position.
	5	Model 2 symbol, ECI protocol not implemented, FNC1 implied in second position.
	6	Model 2 symbol, ECI protocol implemented, FNC1 implied in second position.
GS1 QR	3	Model 2 symbol, ECI protocol not implemented, FNC1 implied in first position.
Aztec	0	Aztec symbol.
	C	Aztec Rune symbol.
Han Xin	0	Generic data, no special features are set. The transmitted data does not follow the AIM ECI protocol.
	1	ECI protocol enabled. There is at least one ECI mode encoded. Transmitted data must follow the AIM ECI protocol.
Mailmark	0	No option specified at this time. Always transmit 0.

Sample Barcodes

This section provides sample barcodes.

Sample Code 39



Sample Code 93

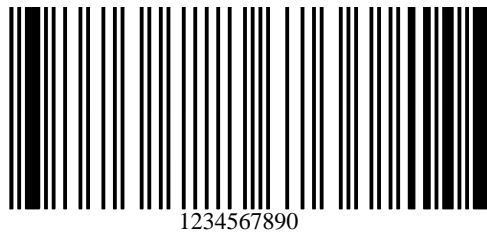

Sample UPC/EAN

UPC-A, 100%



UPC-A Plus 2

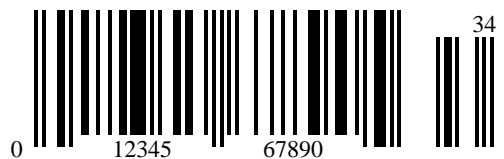

Sample Barcodes

UPC-A Plus 5



UPC-E

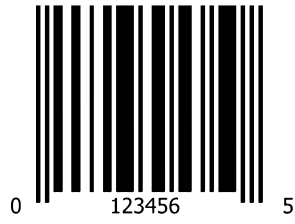

UPC-E Plus 2



UPC-E Plus 5



EAN-8



EAN-13, 100%

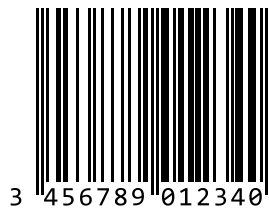

EAN-13 Plus 2



EAN-13 Plus 5



Sample Code 128



Sample Interleaved 2 of 5



Sample Chinese 2 of 5



Sample Matrix 2 of 5



Sample Korean 3 of 5



Sample GS1 DataBar

GS1 DataBar Omnidirectional



NOTE: GS1 DataBar Omnidirectional must be enabled to read the following barcode (see [GS1 DataBar Omnidirectional \(formerly GS1 DataBar-14\)](#)).



GS1 DataBar Limited



NOTE: DataDataBar Limited must be enabled to read the following barcode (see [GS1 DataBar Limited](#)).



GS1 DataBar Expanded



NOTE: DataBar Expanded must be enabled to read the following barcode (see [GS1 DataBar Expanded](#)).

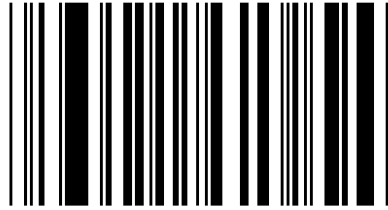

(01)12345678901231

Sample PDF417

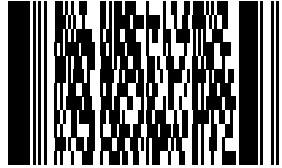

Sample Data Matrix

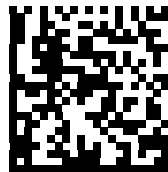

123456789abcdefghijklmnopqrstuvwxy

Sample Maxicode

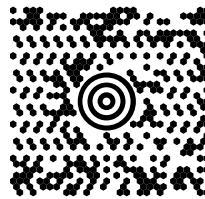

Sample QR Code



0123456789ABCDEFGHIJKLMN0PQRSTUVWXYZ0123456789ABCDEFGHIJKLMN0PQRSTUVWXYZ012345
6789

Sample Aztec



0123456789ABCDEFGHIJKLMNQRSTU VWXYZ0123456789ABCDEFGHIJKLMNQRSTU
WXYZ01234567890123456789ABCDEFGHIJKLMNQRSTU VWXYZ0123456789ABCDEFGHI
JKLMNQRSTU VWXYZ0123456789

Sample Grid Matrix



NOTE: Grid Matrix must be enabled to read the following bar code (see [Grid Matrix](#)).

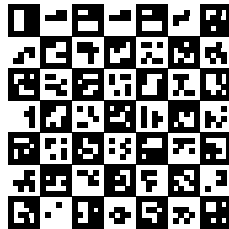

Postal Codes

Sample US Postnet



Sample UK Postal



Numeric Barcodes

For parameters requiring specific numeric values, scan the appropriately numbered barcode(s).

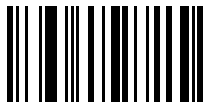

0

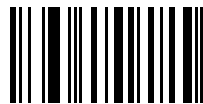

1

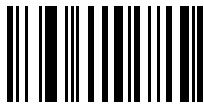

2



3

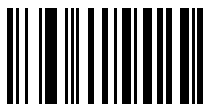

4



5

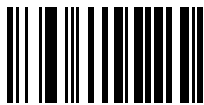

6

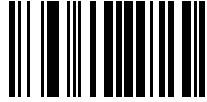

7



8



9

Cancel

To correct an error or change a selection, scan the barcode below.

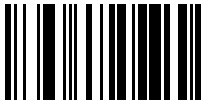

Cancel

Alphanumeric Barcodes

For parameters requiring specific alphanumeric values, scan the appropriately numbered barcode(s).

Cancel

To correct an error or change a selection, scan the barcode below.

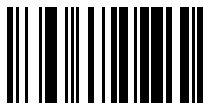

Cancel

Alphanumeric Barcodes

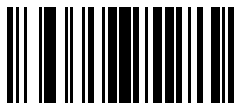

Space



\$

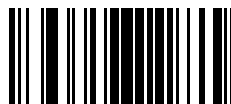

#



%

Alphanumeric Barcodes



*



+

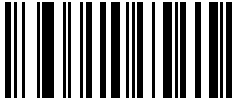

-

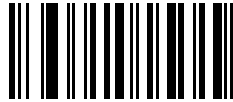

.

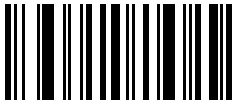

/

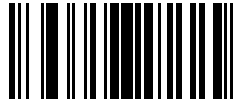

!

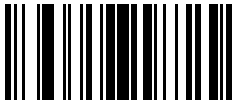

“

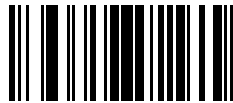

&



<

Alphanumeric Barcodes



)



;



=



?

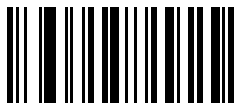

[



(



:

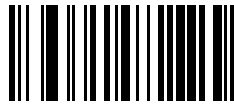

<



>

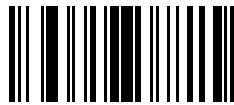

@

Alphanumeric Barcodes



\



]



^

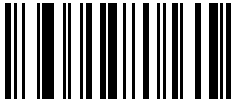

-

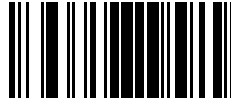

`



NOTE: Do not confuse the following barcodes with those on the numeric keypad.

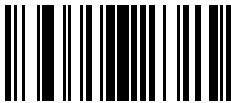

0

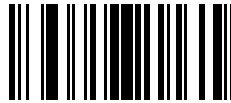

1

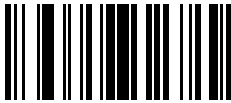

2

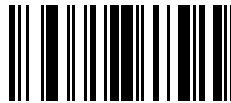

3

Alphanumeric Barcodes



4



5



6

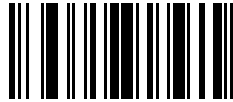

7



8

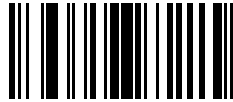

9

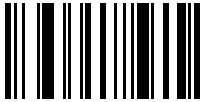

End of Message



Cancel

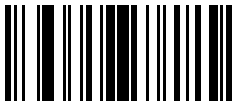

A

Alphanumeric Barcodes



C



E



G



I



K

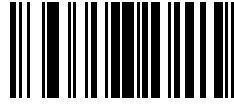

B

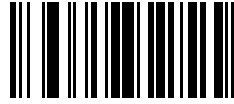

D

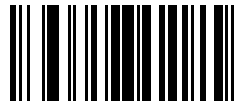

F

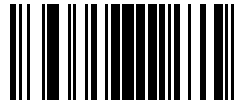

H

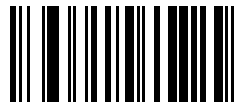

J

Alphanumeric Barcodes



M

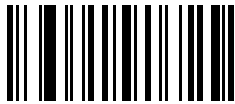

O

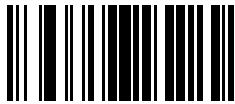

Q

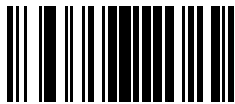

S



L



N

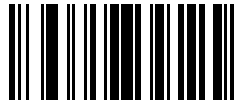

P

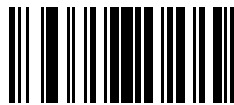

R

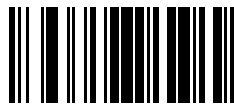

T

Alphanumeric Barcodes

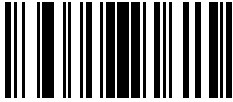

U



V



W

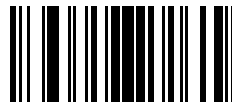

X

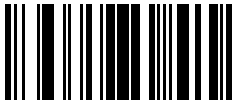

Y

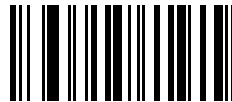

Z

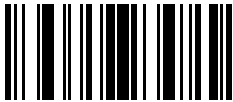

a

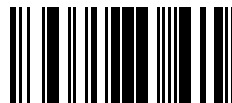

b

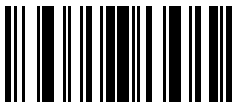

c

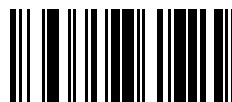

d

Alphanumeric Barcodes



e



f



g

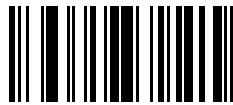

h



i



j

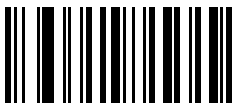

k



l

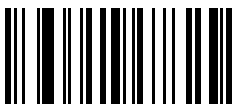

m



n

Alphanumeric Barcodes



o



p

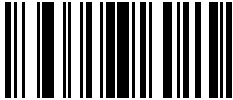

q

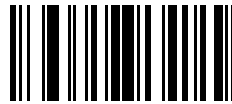

r

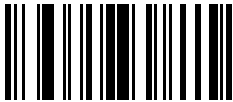

s



t



u

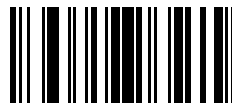

v



w

Alphanumeric Barcodes



y



{



}



x

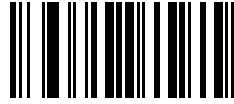

z

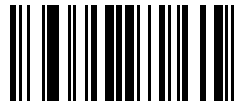

|

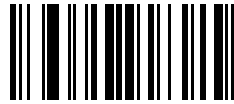

~

ASCII Character Sets



NOTE: For the Keyboard Wedge Interface, Code 39 Full ASCII interprets the barcode special character (\$ + % /) preceding a Code 39 character and assigns an ASCII character value to the pair. For example, if you enable Code 39 Full ASCII and scan +B, it transmits as b, %J as ?, and %V as @. Scanning ABC%i outputs the keystroke equivalent of ABC >.

ASCII Value (Prefix/ Suffix Value)	Full ASCII Code 39 Encode Char	Keystroke	ASCII Character (Applies to RS-232 Only)
1000	%U	CTRL 2	NUL
1001	\$A	CTRL A	SOH
1002	\$B	CTRL B	STX
1003	\$C	CTRL C	ETX
1004	\$D	CTRL D	EOT
1005	\$E	CTRL E	ENQ
1006	\$F	CTRL F	ACK
1007	\$G	CTRL G	BELL
1008	\$H	CTRL H/ BACKSPACE ^a	BCKSPC
1009	\$I	CTRL I/ HORIZONTAL TAB ^d	HORIZ TAB
1010	\$J	CTRL J	LF/NW LN
1011	\$K	CTRL K	VT
1012	\$L	CTRL L	FF
1013	\$M	CTRL M/ ENTER ^c	CR/ENTER
1014	\$N	CTRL N	SO
1015	\$O	CTRL O	SI
1016	\$P	CTRL P	DLE
1017	\$Q	CTRL Q	DC1/XON
1018	\$R	CTRL R	DC2
1019	\$S	CTRL S	DC3/XOFF
1020	\$T	CTRL T	DC4
1021	\$U	CTRL U	NAK

ASCII Character Sets

ASCII Value (Prefix/ Suffix Value)	Full ASCII Code 39 Encode Char	Keystroke	ASCII Character (Applies to RS-232 Only)
1022	\$V	CTRL V	SYN
1023	\$W	CTRL W	ETB
1024	\$X	CTRL X	CAN
1025	\$Y	CTRL Y	EM
1026	\$Z	CTRL Z	SUB
1027	%A	CTRL [ESC
1028	%B	CTRL \	FS
1029	%C	CTRL]	GS
1030	%D	CTRL 6	RS
1031	%E	CTRL -	US
1032	Space	Space	Space
1033	/A	!	!
1034	/B	"	"
1035	/C	#	#
1036	/D	\$	\$
1037	/E	%	%
1038	/F	&	&
1039	/G	'	'
1040	/H	((
1041	/I))
1042	/J	*	*
1043	/K	+	+
1044	/L	,	,
1045	-	-	-
1046	.	.	.
1047	/o	/	/
1048	0	0	0
1049	1	1	1
1050	2	2	2
1051	3	3	3
1052	4	4	4
1053	5	5	5
1054	6	6	6
1055	7	7	7
1056	8	8	8

ASCII Character Sets

ASCII Value (Prefix/ Suffix Value)	Full ASCII Code 39 Encode Char	Keystroke	ASCII Character (Applies to RS-232 Only)
1057	9	9	9
1058	/Z	:	:
1059	%F	;	;
1060	%G	<	<
1061	%H	=	=
1062	%I	>	>
1063	%J	?	?
1064	%V	@	@
1065	A	A	A
1066	B	B	B
1067	C	C	C
1068	D	D	D
1069	E	E	E
1070	F	F	F
1071	G	G	G
1072	H	H	H
1073	I	I	I
1074	J	J	J
1075	K	K	K
1076	L	L	L
1077	M	M	M
1078	N	N	N
1079	O	O	O
1080	P	P	P
1081	Q	Q	Q
1082	R	R	R
1083	S	S	S
1084	T	T	T
1085	U	U	U
1086	V	V	V
1087	W	W	W
1088	X	X	X
1089	Y	Y	Y
1090	Z	Z	Z
1091	%K	[[

ASCII Character Sets

ASCII Value (Prefix/ Suffix Value)	Full ASCII Code 39 Encode Char	Keystroke	ASCII Character (Applies to RS-232 Only)
1092	%L	\	\
1093	%M]]
1094	%N	^	^
1095	%O	_	_
1096	%W	`	`
1097	+A	a	a
1098	+B	b	b
1099	+C	c	c
1100	+D	d	d
1101	+E	e	e
1102	+F	f	f
1103	+G	g	g
1104	+H	h	h
1105	+I	i	i
1106	+J	j	j
1107	+K	k	k
1108	+L	l	l
1109	+M	m	m
1110	+N	n	n
1111	+O	o	o
1112	+P	p	p
1113	+Q	q	q
1114	+R	r	r
1115	+S	s	s
1116	+T	t	t
1117	+U	u	u
1118	+V	v	v
1119	+W	w	w
1120	+X	x	x
1121	+Y	y	y
1122	+Z	z	z
1123	%P	{	{
1124	%Q		
1125	%R	}	}
1126	%S	~	~

ASCII Character Sets

ASCII Value (Prefix/ Suffix Value)	Full ASCII Code 39 Encode Char	Keystroke	ASCII Character (Applies to RS-232 Only)
1127			Undefined
7013			ENTER

- ^a The keystroke in bold transmits only if you enabled Function Key Mapping. Otherwise, the unbold keystroke transmits.
- ^b The keystroke in bold transmits only if you enabled Function Key Mapping. Otherwise, the unbold keystroke transmits.
- ^c The keystroke in bold transmits only if you enabled Function Key Mapping. Otherwise, the unbold keystroke transmits.

Table 36 ALT Key Character Set

ALT Keys	Keystroke
2045	ALT -
2050	ALT 2
2054	ALT 6
2064	ALT @
2065	ALT A
2066	ALT B
2067	ALT C
2068	ALT D
2069	ALT E
2070	ALT F
2071	ALT G
2072	ALT H
2073	ALT I
2074	ALT J
2075	ALT K
2076	ALT L
2077	ALT M
2078	ALT N
2079	ALT O
2080	ALT P
2081	ALT Q
2082	ALT R
2083	ALT S
2084	ALT T
2085	ALT U

Table 36 ALT Key Character Set (Continued)

ALT Keys	Keystroke
2086	ALT V
2087	ALT W
2088	ALT X
2089	ALT Y
2090	ALT Z
2091	ALT [
2092	ALT \
2093	ALT]



NOTE: GUI Shift Keys - The Apple™ iMac keyboard has an apple key on either side of the space bar. Windows-based systems have a GUI key to the left of the left ALT key, and to the right of the right ALT key.

Table 37 GUI Key Character Set

GUI Key	Keystroke
3000	Right Control Key
3048	GUI 0
3049	GUI 1
3050	GUI 2
3051	GUI 3
3052	GUI 4
3053	GUI 5
3054	GUI 6
3055	GUI 7
3056	GUI 8
3057	GUI 9
3065	GUI A
3066	GUI B
3067	GUI C
3068	GUI D
3069	GUI E
3070	GUI F
3071	GUI G
3072	GUI H

Table 37 GUI Key Character Set (Continued)

GUI Key	Keystroke
3073	GUI I
3074	GUI J
3075	GUI K
3076	GUI L
3077	GUI M
3078	GUI N
3079	GUI O
3080	GUI P
3081	GUI Q
3082	GUI R
3083	GUI S
3084	GUI T
3085	GUI U
3086	GUI V
3087	GUI W
3088	GUI X
3089	GUI Y
3090	GUI Z

Table 38 PF Key Character Set

PF Keys	Keystroke
4001	PF 1
4002	PF 2
4003	PF 3
4004	PF 4
4005	PF 5
4006	PF 6
4007	PF 7
4008	PF 8
4009	PF 9
4010	PF 10
4011	PF 11
4012	PF 12

Table 38 PF Key Character Set (Continued)

PF Keys	Keystroke
4013	PF 13
4014	PF 14
4015	PF 15
4016	PF 16

Table 39 F Key Character Set

F Keys	Keystroke
5001	F 1
5002	F 2
5003	F 3
5004	F 4
5005	F 5
5006	F 6
5007	F 7
5008	F 8
5009	F 9
5010	F 10
5011	F 11
5012	F 12
5013	F 13
5014	F 14
5015	F 15
5016	F 16
5017	F 17
5018	F 18
5019	F 19
5020	F 20
5021	F 21
5022	F 22
5023	F 23
5024	F 24

Table 40 Numeric Key Character Set

Numeric Keypad	Keystroke
6042	*
6043	+
6044	Undefined
6045	-
6046	.
6047	/
6048	0
6049	1
6050	2
6051	3
6052	4
6053	5
6054	6
6055	7
6056	8
6057	9
6058	Enter
6059	Num Lock

Table 41 Extended Key Character SetExtended Keypad

Extended Keypad	Keystroke
7001	Break
7002	Delete
7003	Pg Up
7004	End
7005	Pg Dn
7006	Pause
7007	Scroll Lock
7008	Backspace
7009	Tab
7010	Print Screen
7011	Insert
7012	Home

Table 41 Extended Key Character SetExtended Keypad (Continued)

Extended Keypad	Keystroke
7013	Enter
7014	Escape
7015	Up Arrow
7016	Dn Arrow
7017	Left Arrow
7018	Right Arrow

Communication Protocol Functionality

This section provides information about functionality supported via communication (cable) interface. The following table lists supported scanner functionality by communication protocol.

Table 42 Communication Interface Functionality

Communication Interfaces	Functionality		
	Data Transmission	Remote Management	Image and Video Transmission
USB			
HID Keyboard Emulation	Supported	Not Available	Not Available
CDC COM Port Emulation	Supported	Not Available	Not Available
SSI over CDC COM Port Emulation	Supported	Supported	Supported
IBM Table-top USB	Supported	Supported	Not Available
IBM Hand-held USB	Supported	Supported	Not Available
USB OPOS Hand-held	Supported	Supported	Not Available
Symbol Native API (SNAPI) without Imaging Interface	Supported	Supported	Not Available
Symbol Native API (SNAPI) with Imaging Interface	Supported	Supported	Supported
RS-232			
Standard RS-232	Supported	Not Available	Not Available
ICL RS-232	Supported	Not Available	Not Available
Fujitsu RS-232	Supported	Not Available	Not Available
Wincor-Nixdorf RS-232 Mode A	Supported	Not Available	Not Available
Wincor-Nixdorf RS-232 Mode B	Supported	Not Available	Not Available
Olivetti ORS4500	Supported	Not Available	Not Available
Omron	Supported	Not Available	Not Available
CUTE	Supported	Not Available	Not Available
OPOS/JPOS	Supported	Not Available	Not Available
SSI	Supported	Supported	Supported

Table 42 Communication Interface Functionality (Continued)

Communication Interfaces	Functionality		
	Data Transmission	Remote Management	Image and Video Transmission
IBM 4690			
Hand-held Scanner Emulation (Port 9B)	Supported	Not Available	Not Available
Table-top Scanner Emulation (Port 17)	Supported	Supported	Not Available
Non-IBM Scanner Emulation (Port 5B)	Supported	Supported	Not Available
Keyboard Wedge			
IBM PC/AT & IBM PC Compatibles	Supported	Not Available	Not Available
IBM AT Notebook	Supported	Not Available	Not Available

Signature Capture Code

CapCode, a signature capture code, is a special pattern that encloses a signature area on a document and allows a scanner to capture a signature.

There are several accepted patterns that allow automatic identification of different signatures on the same form. For example, on the federal tax return 1040 form there are three signature areas, one each for two joint filers, and one for a professional preparer. By using different patterns, a program can correctly identify all three, so they can be captured in any sequence and still be identified correctly.

Code Structure

This section provides details on CapCode and the signature capture box.

Signature Capture Area

A CapCode is printed as two identical patterns on either side of a signature capture box.

Each pattern extends the full height of the signature capture box. For an example, see [the figure below](#).

The box is optional, so you can omit it, replace it with a single baseline, or print a baseline with an "X" on top of it towards the left, as is customarily done in the US to indicate a request for signature. However, if an "X" or other markings are added in the signature box area, these are captured with the signature.

Figure 14 CapCode



CapCode Pattern Structure

A CapCode pattern structure consists of a start pattern followed by a separator space, a signature capture box, a second separator space, and then a stop pattern. Assuming that X is the dimension of the thinnest element, the start and stop patterns each contains 9X total width in 4 bars and 3 spaces. A 7X quiet zone is required to the left and to the right of the CapCode pattern.

Figure 15 CapCode Structure

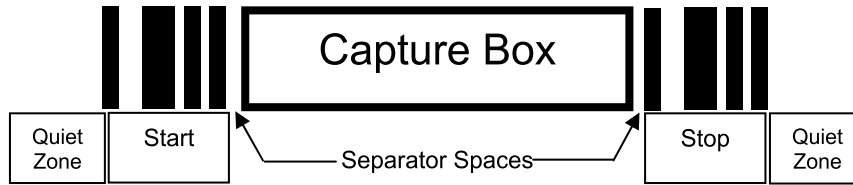

The separator spaces on either side of the signature capture box can be between 1X and 3X wide.

Start / Stop Patterns

This section lists the accepted start / stop patterns. The bar and space widths are expressed as multiples of X.

You must use the same pattern on either side of a signature capture box. The type value is reported with the captured signature to indicate the purpose of the signature captured.

Table 43 Start / Stop Pattern Definitions

Bar/Space Patterns							Type
B	S	B	S	B	S	B	
1	1	2	2	1	1	1	2
1	2	2	1	1	1	1	5
2	1	1	2	1	1	1	7
2	2	1	1	1	1	1	8
3	1	1	1	1	1	1	9

[Table 44 User Defined CapCode Parameters](#) on page 432 lists selectable parameters used to generate the image of the captured signature.

Table 44 User Defined CapCode Parameters

Parameter	Defined
Width	Number of pixels
Height	Number of pixels
Format	JPEG, BMP, TIFF
JPEG quality	1 (most compression) to 100 (best quality)
Bits Per Pixel (not applicable to JPEG format)	1 (2 levels)
	4 (16 levels)
	8 (256 levels)

BMP format does not use compression, JPEG and TIFF formats do.

Dimensions

The size of the signature capture box is determined by the height and separation of the start and stop patterns. The line width of the signature capture box is insignificant.

The thinnest element width, referred to here as *X*, is nominally 10 mils (1 mil = 0.0254 mm). Select this as an exact multiple of the pixel pitch of the printer used. For example, when using a 203 DPI (dots-per-inch) printer and printing 2 dots per module, the resulting *X* dimension is 9.85 mils.

Data Format

Zebra decoders allow different user options to output or inhibit barcode type. Selecting "Symbol ID" as the barcode type for output identifies the CapCode with letter "i".

The decoder output is formatted according to the following table.

Table 45 Data Format

File Format (1 byte)	Type (1 byte)	Image Size (4 bytes, BIG Endian)	Image Data
JPEG - 1 BMP - 3 TIFF - 4	See Table 43 Start / Stop Pattern Definitions on page 432, last column		(Same bytes as in a data file)

Additional Capabilities

Regardless of how the signature is captured, the output signature image is de-skewed and right-side up.

A scanner that captures signatures automatically determines whether it is scanning a signature or a barcode. You can disable the signature capturing capability in a decoder.

Signature Boxes

This section illustrates the five acceptable signature boxes:

Figure 16 Acceptable Signature Boxes

Type 2:



Type 5:



Type 7:



Type 8:



Type 9:



Non-Parameter Attributes

This section defines the scanner's non-parameter attributes.

Model Number

Attribute #533

number of the scanner. This electronic output matches the printout on the physical device label.

Type	S
Size (Bytes)	18
User Mode Access	R
Values	Variable

Serial Number

Attribute #534

Unique serial number assigned in the manufacturing facility. This electronic output matches the printout on the physical device label, for example M1J26F45V.

Type	S
Size (Bytes)	16
User Mode Access	R
Values	Variable

Date of Manufacture

Attribute #535

Date of device manufacture assigned in the manufacturing facility. This electronic output matches the printout on the physical device label, for example 30APR14 (which reads the 30th of April 2014).

Type	S
Size (Bytes)	7
User Mode Access	R

Values	Variable
--------	----------

Date of First Programming

Attribute #614

Date of first electronic programming represents the first time settings were electronically loaded to the scanner either by 123Scan or via SMS, for example 18MAY14 (which reads the 18th of May 2014).

Type	S
Size (Bytes)	7
User Mode Access	R
Values	Variable

Configuration Filename

Attribute #616

The name assigned to the configuration settings loaded electronically to the device either by 123Scan or via SMS.



NOTE: Scanning the Set Defaults barcode automatically changes the configuration filename to factory defaults.

To indicate the configuration settings loaded to the device were changed, the configuration filename changes to Modified upon scanning any parameter barcode.

Type	S
Size (Bytes)	17
User Mode Access	RW
Values	Variable

Beeper/LED

Attribute #6000

Activates the beeper and/or LED.

Type	X
Size (Bytes)	N/A
User Mode Access	W
Values	See Beeper/LED Values

Table 46 Beeper/LED Values

Beep / LED Action	Value	Beep / LED Action	Value
1 high short beep	0	1 low long beep	15
2 high short beeps	1	2 low long beeps	16
3 high short beeps	2	3 low long beeps	17
4 high short beeps	3	4 low long beeps	18
5 high short beeps	4	5 low long beeps	19
1 low short beep	5	Fast warble beep	20
2 low short beeps	6	Slow warble beep	21
3 low short beeps	7	High-low beep	22
4 low short beeps	8	Low-high beep	23
5 low short beeps	9	High-low-high beep	24
1 high long beep	10	Low-high-low beep	25
2 high long beeps	11	High-high-low-low beep	26
3 high long beeps	12	Green LED off	42
4 high long beeps	13	Green LED on	43
5 high long beeps	14	Red LED on	47
		Red LED off	48

Parameter Defaults

Attribute #6001

This attribute restores all parameters to their factory defaults.

Type	X
Size (Bytes)	N/A
User Mode Access	W
Values	0 = Restore Defaults 1 = Restore Factory Defaults 2 = Write Custom Defaults

Beep on Next Bootup

Attribute #6003

This attribute configures (enables or disables) beep on next boot up of scanner.

Type	X
Size (Bytes)	N/A
User Mode Access	W
Values	0 = Disable beep on next bootup 1 = Enable beep on next bootup

Reboot

Attribute #6004

This attribute initiates a device reboot.

Type	X
Size (Bytes)	N/A
User Mode Access	W
Values	N/A

Host Trigger Session

Attribute #6005

This attribute triggers a decode session similar to manually depressing the scanner trigger button.

Type	X
Size (Bytes)	N/A
User Mode Access	W
Values	1 = Start Host Trigger Session 0 = Stop Host Trigger Session

Firmware Version

Attribute #20004

The scanner's operating system version. For example, NBRFMAAC or PAAAABS00-007-R03D0.

Type	S
Size (Bytes)	Variable
User Mode Access	R
Values	Variable

Scankit Version

Attribute #20008

Identifies the 1D decode algorithms resident on the device, for example SKIT4.33T02.

Type	S
Size (Bytes)	Variable
User Mode Access	R
Values	Variable

