



by Schneider Electric

User Manual Easy UPS On-Line SRV Series Extended Runtime 6000VA, 10000VA

Important Safety Information

Read the instructions carefully and look at the equipment to become familiar with the device before trying to install, operate, service or maintain it. The following special messages may appear throughout this document or on the equipment to warn of potential hazards or to call attention to information that clarifies or simplifies a procedure.



The addition of this symbol to a Danger or Warning product safety label indicates that an electrical hazard exists that will result in personal injury if the instructions are not followed.



This is the safety alert symbol. It is used to alert you to potential personal injury hazards. Obey all safety messages that follow this symbol to avoid possible injury or death.

⚠ DANGER

DANGER indicates a hazardous situation which, if not avoided, **will result in death or serious injury**.

⚠ WARNING

WARNING indicates a hazardous situation which, if not avoided, **could result in death or serious injury**.

⚠ CAUTION

CAUTION indicates a hazardous situation which, if not avoided, **could result in minor or moderate injury**.

NOTICE

NOTICE is used to address practices not related to physical injury.

For Professional Business Applications – Not For Consumer Use

Safety and General Information

SAVE THESE INSTRUCTIONS

This manual contains important instructions that should be followed during installation and maintenance of the UPS and batteries.

Inspect the package contents upon receipt. Notify the carrier and dealer if there is any damages.

- This UPS is for indoor use only.
- Do not operate this UPS in direct sunlight, in contact with fluids, or where there is excessive dust or high humidity.
- Do not operate the UPS near open windows or doors.
- Be sure the air vents on the UPS are not blocked. Allow adequate space for proper ventilation.

Note: Allow a minimum of 20 cm clearance on all four sides of the UPS.

- Environmental factors impact battery life. Elevated ambient temperatures, poor quality utility power, and frequent discharges will shorten battery life. Follow the battery manufacturer recommendations.
- Connect the UPS power cable directly to a wall outlet. Do not use surge protectors or extension cords.

Electrical Safety

- When grounding cannot be verified, disconnect the equipment from the utility power outlet before installing or connecting to other equipment. Reconnect the power cord only after all connections are made.
- Connection to the branch circuit (mains) must be performed by a qualified electrician.
- The protective earth conductor for the UPS carries the leakage current from the load devices (computer equipment). An insulated ground conductor is to be installed as part of the branch circuit that supplies the UPS. The conductor must have the same size and insulation material as the grounded and ungrounded branch circuit supply conductors. The conductor will be green and with or without a yellow stripe.
- The grounding conductor is to be grounded to earth at the service equipment, or if supplied by a separately derived system, at the supply transformer or motor generator set.

Battery Safety

▲ CAUTION

RISK OF HYDROGEN SULPHIDE GAS AND EXCESSIVE SMOKE

- Replace the battery at least every 5 years.
- Replace the battery immediately when the UPS indicates battery replacement is necessary.
- Replace battery at the end of its service life.
- Replace batteries with the same number and type of batteries as originally installed in the equipment.
- Replace the battery immediately when the UPS indicates a battery over-temperature condition, or UPS internal over-temperature, or when there is evidence of electrolyte leakage. Power off the UPS, unplug it from the AC input, and disconnect the batteries. Do not operate the UPS until the batteries have been replaced.

Failure to follow these instructions can result in minor or moderate injury and equipment damage.

- Servicing of user replaceable batteries should be performed or supervised by personnel knowledgeable about batteries and required precautions. In this case, batteries is not user replaceable.
- APC by Schneider Electric uses Maintenance-Free sealed Lead Acid batteries. Under normal use and handling, there is no contact with the internal components of the batteries. Over charging, over heating or other misuse of batteries can result in a discharge of battery electrolyte. Released electrolyte is toxic and may be harmful to the skin and eyes.
- Use tool with insulated handles.
- Wear rubber gloves and boots.
- Determine if battery is either intentionally or inadvertently grounded. Contact with any part of a grounded battery can result in electric shock and burns by high short-circuit current. The risk of such hazards can be reduced if grounds are removed during installation and maintenance by a skilled person.

Radio Frequency Warning

This is a product for commercial and industrial application in the second environment – installation restrictions or additional measures may be needed to prevent disturbances.

Product Description

The APC by Schneider Electric Easy UPS is a high performance, uninterruptible power supply (UPS). The UPS provides protection for electronic equipment from utility power blackouts, brownouts, sags, and surges and small utility fluctuations and large disturbances. The UPS also provides battery backup power for connected equipment until utility power returns to normal levels or the batteries are fully discharged.

This user manual is available on the enclosed documentation CD and on the APC by Schneider Electric website, www.apc.com.

Package Contents

Read the Safety Guide before installing the UPS.

The packaging is recyclable; save it for reuse or dispose of it properly.

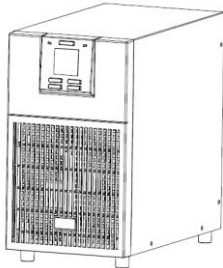

(1)
UPS



(1)
User manual



(1)
Software, User
documentation CD



(1)
USB cable

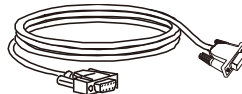

(1)
RS-232 cable

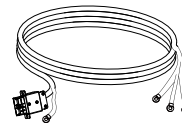

(1)
Battery cable

NOTE: The model and serial numbers are located on a small, rear panel label.

Optional Accessories

For optional accessories, refer to the APC by Schneider Electric Website at www.apc.com.

Specifications

Environment Specifications

NOTICE



RISK OF EQUIPMENT DAMAGE

- UPS must be used indoors only.
- The installation location should be sturdy to withstand the weight of the UPS.
- Do not operate UPS where there is excessive dust or where the temperature or humidity are outside specified limits.

Failure to follow these instructions can result in equipment damage.

Temperature	Operating	0° to 40°C at rated load. 40° to 45°C linearly derated to 85% of maximum load capacity. 45° to 50°C linearly derated to 75% of maximum load capacity.	<p>This unit is intended for indoor use only. Select a location sturdy enough to handle the weight. Do not operate UPS where there is excessive dust or where the temperature or humidity are outside specified limits. Note: Charge the battery modules every six months during storage. (If applicable)</p>
	Storage	-15° to 60°C	
Elevation	Operating	0 - 1,000 m: normal operation 1,000 - 3,000 m: The load reduces @ 1% at an increased height of every 100 m > 3,000 m: UPS will not work	
	Storage	0 - 15,000 m	
Humidity		0 to 95% relative humidity, non-condensing	
IP Rating		IP20	

Physical Specifications

UPS model	SRV Extended Runtime 6000VA	SRV Extended Runtime 10000VA
Dimensions with package Width x Height x Depth	290 mm (11.42in) x 460 mm (18.11in) x 491 mm (19.33 in)	290 mm (11.42in) x 460 mm (18.11in) x 570 mm (22.44 in)
Dimensions without package Width x Height x Depth	190 mm (7.48 in) x 336mm (13.23in) x 374 mm (14. 72 in)	190 mm (7.48 in) x 336mm (13.23in) x 447 mm (17.6 in)
Weight with package	16kg	19.5kg
Weight without package	13kg	16.5kg
Lifting guidelines	< 18 kg (< 40 lb) 	18 - 32 kg (40 - 70lb) 

Input/Output Specifications

UPS Model	SRV Extended Runtime 6000VA	SRV Extended Runtime 10000VA	
Input	Voltage	230 Vac Nominal	
	Frequency	50 Hz / 60 Hz	
	Input Voltage Range (100% load)	176 Vac – 300 Vac ± 3%	
	Input Voltage Range (60% load)	110 Vac – 300 Vac ± 3%	
	Input Power Factor (100% resistive load)	≥ 0.99 at 100% load	
	Input Protection	Thermal circuit breaker	
Output	UPS Capacity	6000 VA / 6000 W	10000 VA / 10000 W
	Nominal Output Voltage	230 Vac	
	Other Programmable Voltage	220 Vac, 240 Vac	
	Efficiency at rated load	94% max.	
	Output Voltage Regulation	± 1% static	
	Output Voltage Distortion	<ul style="list-style-type: none"> • 1% max. for full linear load, • 4% max. for full RCD load (100% VA, 0.8 PF) 	
	Frequency – On Battery	50 Hz ± 0.1 Hz / 60 Hz ± 0.1 Hz	
	Frequency – AC Mode	50 Hz ± 4 Hz / 60 Hz ± 4 Hz	
	Crest Factor	3:1	
	Waveform	Sinewave	
	Output Connection	Terminal	
	Bypass	Internal bypass	
	Bypass Range	185 Vac – 250 Vac ± 1%	

Battery

UPS Model	SRV Extended Runtime 6000VA	SRV Extended Runtime 10000VA
Configuration	External battery	
Type	Sealed maintenance free (SMF) 12 V, 9 Ah	Sealed maintenance free (SMF) 12 V, 9 Ah
Battery Bank Voltage	240 V	240 V

Front Panel Display

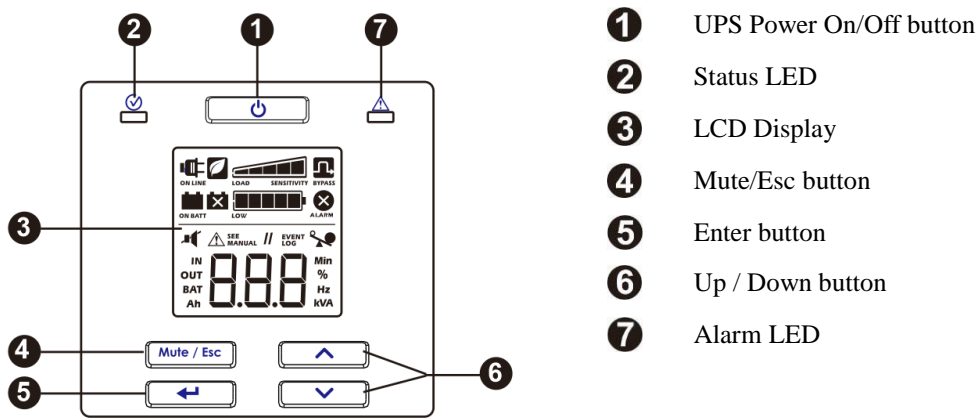

Rear Panel Features

SRV Extended Runtime 6000VA/SRV Extended Runtime 10000VA

Terminal View

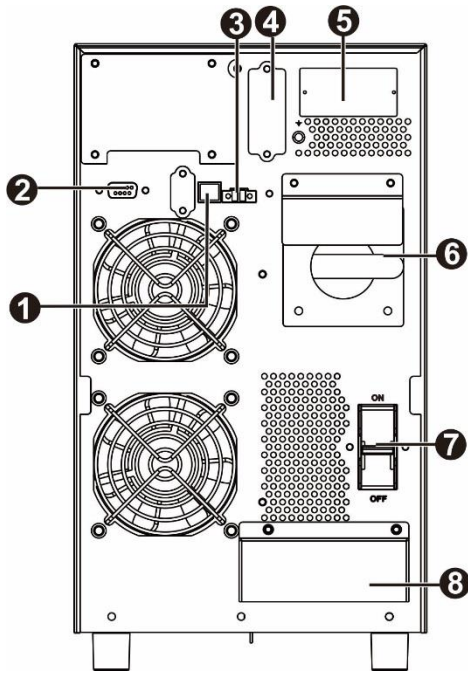
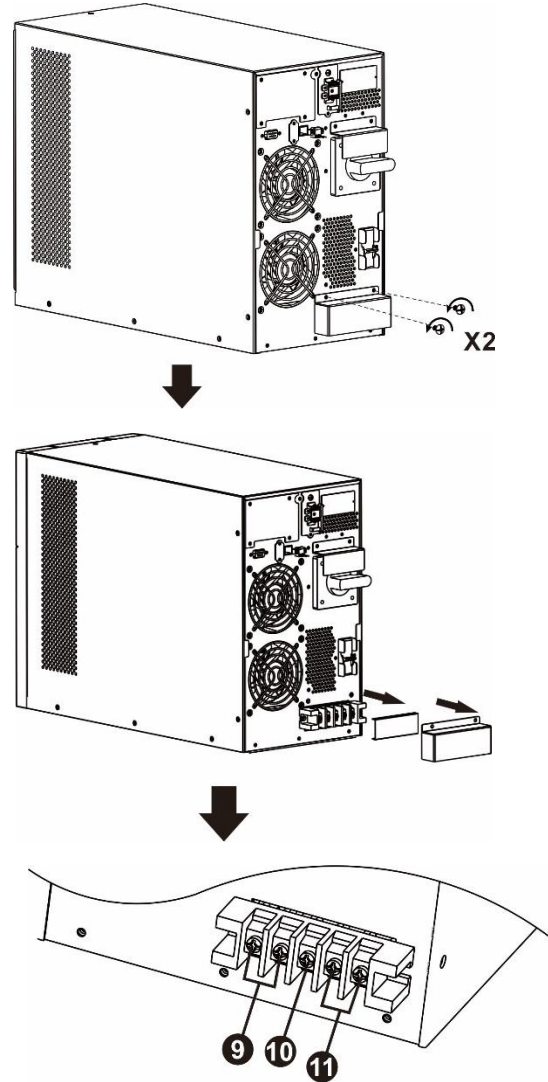

- 1** USB port
- 2** RS-232
- 3** Emergency Power Off (EPO)
- 4** Battery connector
- 5** Intelligent card slot
- 6** Maintenance bypass
- 7** Input circuit breaker
- 8** Input/Output terminal (Please refer to Terminal view for the details.)
- 9** Output terminals
- 10** Ground terminal
- 11** Input terminals

Basic Connectors

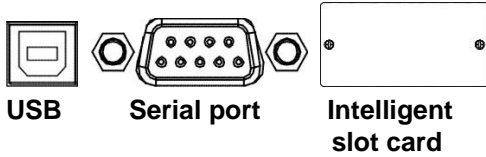

Power management software and interface kits can be used with the UPS.

Use only interface kits supplied or approved by Schneider Electric.

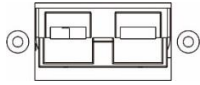

Battery connector

This UPS is not equipped internal battery. Before turn on the UPS. Please connect the battery by connecting battery cable to external battery.

Start Up Settings

Connect the battery

Connect UPS to the external battery pack with a battery cable. Refer to right chart for external battery connection.

- Please connect the battery according to the battery voltage indicated on the rear panel. If the connected battery voltage is incorrect, UPS may be damaged and cannot be repaired. Therefore, be sure to confirm that the battery voltage is in accordance with the UPS specification.
- Be sure to respectively connect red cable to the positive terminal and black cable to the negative terminal of external battery system. Be sure grounding (green cable) is connected firmly.

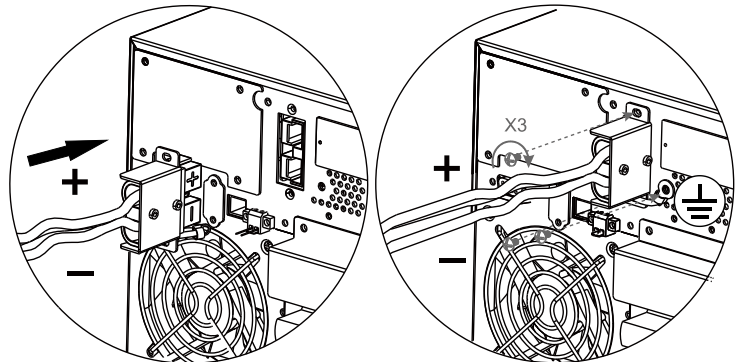

Set up battery charging current

This extended runtime UPS should be set up battery charging current according to the connected external battery pack numbers. APC by Schneider Electric offers standard battery pack with 20 pieces of 12V9AH. When connecting to external battery pack, please follow below table to setup battery charging current.

Connected battery pack numbers in parallel	1	2	3	≥ 4
Charging current	1A	2A	3A	4A

Connect power and equipment to the UPS

⚠ CAUTION

HAZARD OF ELECTRIC SHOCK

- All electrical work must be performed by a qualified electrician.
- Adhere to all national and local electrical codes.
- Disconnect the mains power and internal batteries before installing or servicing the UPS or connected equipment.
- UPS AC hardwired and pluggable outlets may be energized by remote or automatic control at any time.
- Do not use the UPS as safety disconnect.
- Turn off all power to this equipment before working on the equipment. Practice lockout/tagout procedures.
- Do not wear jewelry when working with electrical equipment.

Failure to follow these instructions can result in minor or moderate injury.

1. Connect equipment to the UPS. Avoid using extension cords.
2. Connect input utility power to the UPS.
3. Switch on the input utility power. Then, the UPS display panel will illuminate when utility power is available.



Start the UPS

Press the  button located on the front panel of the UPS.

- The battery charges to 90% capacity during the first five hours of normal operation.
- **Do not** expect full battery run capability during this initial charge period.

Cold start the UPS

Use cold start feature to supply power to connected equipment from the UPS batteries.

Press the  button. Then, the display panel will illuminate. Press the  button again to supply battery power to the connected equipment.

Connect and install management software

Easy UPS SRV is provided with SchneiderUPS management software for unattended operating system shutdown, UPS monitoring, UPS control and energy reporting. The following diagram is a representation of a typical server installation.

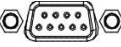
1. Connect the USB cable from the rear of the UPS  to the protected device such as a server.
2. For a server or other device with an operating system, load the SchneiderUPS CD and follow the on-screen set-up instructions.
3. A built-in serial port  is also available for additional communication options with serial cable.
4. Even more communication options are available via the built-in intelligent card slot. Refer to www.apc.com for more information.

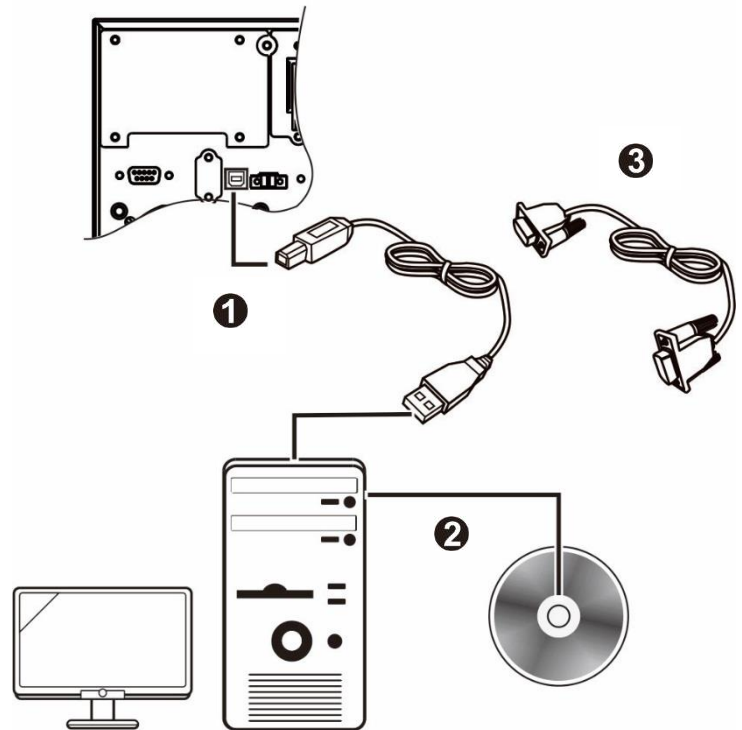

Emergency Power Off

The Emergency Power Off (EPO) function is a feature that will immediately remove power to all connected equipment. When EPO button is pushed, all connected equipment will immediately turn off and will not switch to battery power.

Adhere to all national and local electrical codes. Wiring must be performed by a qualified electrician.

The EPO switch is internally powered by the UPS for use with non-powered switches or potential free contacts.

Normally closed (N/C) contacts

1. Remove the EPO connector screws beneath pins 1 and 2.
2. Remove the metal link between pins 1 and 2.
3. Connect N/C relay contacts between pins 1 and 2 of the EPO terminal block. Use 0.5 to 1 mm² wire.
4. Secure the EPO connector screws beneath pins 1 and 2.

If the N/C is open, the UPS will turn off and power will be removed from the load.

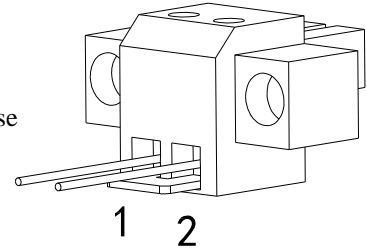

NOTICE

EQUIPMENT DAMAGE

- Do not connect the EPO interface to any circuit other than a unused circuit.

Failure to follow these instructions can result in equipment damage.

The EPO interface is a Safety Extra Low Voltage (SELV) circuit. Connect it only to other SELV circuits. The EPO interface monitors circuits that have no determined voltage potential. Such closure circuits may be provided by a switch or relay properly isolated from the utility. To avoid damage to the UPS, do not connect the EPO interface to any circuit other than a unused circuit.

Use one of the following cable types to connect the UPS to the EPO switch.

- CL2: Class 2 cable for general use.
- CL2P: Plenum cable for use in ducts, plenums, and other spaces used for environmental air.
- CL2R: Riser cable for use in a vertical run in a floor-to-floor shaft.
- CLEX: Limited use cable for use in dwellings and for use in raceways.

Maintenance Bypass

Maintenance bypass enables the user to isolate the electronic circuitry of the UPS from the mains and the load without interrupting the load operation by connecting the loads directly to the bypass utility supply.







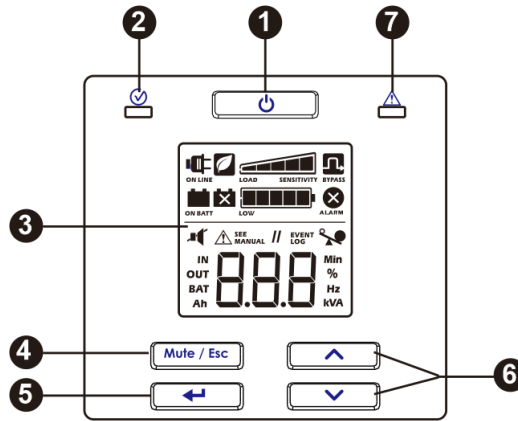

- This feature is useful while performing maintenance or service and shall only be executed by authorized Technical Service Personnel.
- During Maintenance Bypass operation; in case of any mains interruption occurs, all loads on the output will be deenergized. Maintenance Bypass Operation should not be preferred for long time use.

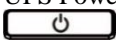
Operation

Using The Display

These Easy UPS models are equipped with an intuitive and configurable LCD display. This display complements the software interface as they convey similar information and either may be used to configure the UPS settings. The display consists of the following keys and indicators:



1	UPS Power On/Off button 	<ul style="list-style-type: none"> ● Press this button to turn on the UPS. ● Press and hold this button until a beep is heard to turn off the UPS. ● Press this button to reset alarms.
2	Status LED 	<p>The Status LED illuminates green when the power is on. This LED indicates two different states of output power:</p> <ul style="list-style-type: none"> ● Output off: LED blinks. Press Power On/Off button to turn the output power on. ● Output on: LED illuminates green continuously.
3	LCD Display	<p>The display interface options are visible on this LCD screen. Press the  or  button to activate LCD, if the display is not illuminated.</p>
4	Mute/Esc button 	<ul style="list-style-type: none"> ● To acknowledge audible alarms and suppress them temporarily. ● To exit a sub menu and return to the main menu.
5	Enter button 	<p>Press this button to enter the menu or to select a menu item/ value during navigation.</p>
6	Up / Down button  	<p>Press these two buttons to scroll through the main menu options and display screens.</p>
7	Alarm LED 	<p>This Alarm LED illuminates red when the UPS detects an error and blinks red for UPS notifications. See “Alarms” on page 12 and “Notifications” on page 14 in this manual.</p>

LCD Display Icons

	On Line: The UPS is drawing utility power and performing double conversion to supply power to the connected equipment.
ON LINE	
	On Battery: The UPS is supplying battery backup power to the connected equipment.
ON BATT	
	Replace Battery: The battery is not connected securely or the battery is nearing the end of its service life and should be replaced.
	Bypass: The UPS is in bypass mode, sending utility power directly to connected equipment. Bypass mode operation is the result of an internal UPS event or an overload condition. Under this condition, see “Alarms” on page 12 and “Notifications” on page 14 in this manual. This icon in combination with Green Mode icon, indicates that the UPS is in green mode operation.
BYPASS	
	System Alarms: An internal fault is detected. See “Alarms” on page 12 in this manual.
ALARM	
	Overload: The equipment connected to the UPS is drawing more power than rated.
	Battery Charge: The battery charge level is indicated by the number of bar sections illuminated. When all five blocks are illuminated, the battery is fully charged. Each bar represents approximately 20% of the battery charge capacity.
LOW	
	Load Level: The load percentage is indicated by the number of load bar sections illuminated. Each bar represents approximately 20% of the maximum load capacity.
LOAD	
SENSITIVITY	
	Mute: An illuminated line through the icon indicates that the audible alarm is disabled.
	Green Mode: An illuminated icon indicates that the unit is working in Green mode. The connected equipment is receiving the utility input directly as long as the input voltage and frequency are within the configured limits.
	Alarm or notification: The UPS has detected an error or the UPS is in configuration mode. See “Notifications” on page 14 in this manual.
SEE MANUAL	
EVENT LOG	Event: The icon is illuminated when the user is viewing the event log.

Alarms and System Errors

Status Indicators

One beep every second	Low Battery State - The battery is nearing its complete discharge state. The UPS is about to shut down.
4 beeps every 30 sec (first beep starts after 4 sec on battery)	Overload condition - The equipment connected to the UPS is drawing more power than rated.
Beeper continuously on	On Battery State - The UPS is supplying battery backup power to the connected equipment.
Two short beeps every 5 sec	Alarm State - UPS has detected an error. See “Alarms” on page 12 in this manual.
	Event Bypass State - UPS has detected an error. Connected equipment receives utility input power through the bypass relay.

Alarms

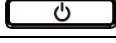
Display code	Description	Solution
SC	UPS has experienced a short circuit at the output. Unit will try to auto-recover from this condition.	Check if there is any short circuit at the UPS output. Remove the short circuit wait the unit auto-recover or Press  button to start the UPS. Note: The power supplied to the connected equipment is dropped when the UPS is in this condition.
OL	UPS is experiencing an overload condition.	Disconnect nonessential equipment from the UPS to eliminate the overload condition.
dCH	The UPS has detected a DC voltage error. Unit will try to auto-recover from this condition.	If the UPS does not recover automatically, contact APC by Schneider Electric.
Hot	Temperature of the unit is rising above the set limits.	Disconnect nonessential equipment from the UPS to reduce the UPS load. Ensure that ambient temperature is within limits. Ensure that adequate clearance is maintained.
CH9	UPS has detected a charger error.	Verify if there is any short circuit at the UPS battery terminal. Press  button to start the UPS.
b5F	Bus start failure detected.	Contact your dealer.
b5U	Bus under	Contact your dealer.
b5N	Bus unbalance	Contact your dealer.

Display code	Description	Solution
ISF	Inverter soft start failure detected	Contact your dealer.
UNF	High Inverter voltage	Contact your dealer.
LNf	Low Inverter voltage	Contact your dealer.
INP	Negative power alert	Contact your dealer.
OC	Inverter over current	Contact your dealer.
SPS	SPS abnormal	Contact your dealer.
OPr	Battery SCR short circuited	Contact your dealer.
IrS	Inverter relay short circuited	Contact your dealer.
CCF	CAN communication alert	Contact your dealer.
CF	CAN communication alert	Contact your dealer.
CF	CPU communication failure detected	Contact your dealer.
SbF	Battery turn-on failure detected	Contact your dealer.
PbF	PFC current failure detected in battery mode	Contact your dealer.
bvF	Bus voltage changes too fast	Contact your dealer.
CdF	Current detect alert	Contact your dealer.

Contact APC by Schneider Electric for all other alarm codes.

Notifications

Display code	Description	Solution
bdc	Battery is not connected.	Connect battery to the UPS. See “Start Up Settings” on page 7 in this manual.
oc	Over charge	Contact your dealer.
OL	UPS is overload. Devices connected to the UPS are fed directly by the electrical network via the bypass.	Remove excess loads from UPS output.
FF	Fan failure detected.	Contact your dealer.
EPO	EPO enabled.	Set the circuit in closed position to disable EPO function.
bl	Low battery.	Contact your dealer.
ot	Over temperature	Contact your dealer.
CHF	Charger failure detected	Contact your dealer.
Ld	Line situations are different in parallel system	Contact your dealer.
bd	Bypass situations are different in parallel system	Contact your dealer.
OLb	Locked in bypass after overload 3 times in 30 minutes.	Contact your dealer.
CO	Cover of maintenance bypass is open.	Contact your dealer.
FU	Bypass unstable	Contact your dealer.

UPS Display Parameters

Operational data displayed in the display panel is given in the table.















Navigate using the  or  button.

Parameter	Units	Indicator Icons
Output voltage	Vac	OUT, V
Output frequency	Hz	OUT, Hz
Input voltage	Vac	IN, V
Input frequency	Hz	IN, Hz
Battery voltage	V DC	BAT, V
Charging current	A	BAT, A
Ambient temperature	°C	NUMBER, C
State of battery charge	%	BAT, %
Load level in percentage (Maximum of Watts or VA)	%	OUT, %
Load level in kVA	kVA	OUT, kVA
Total Ah capacity of connected battery	Ah	BAT, Ah
Remaining On Battery runtime	Minutes	BAT, Min
Ah capacity of connected battery	Ah	BAT, AH

Configuration

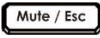
Configure UPS Parameters

Follow the steps to configure parameters in the UPS:



1. Press the  button.
2. Press the  or  button to navigate to “Set”.
3. Press the  button.
4. Navigate through the parameters using the  or  button.
5. Press the  button to edit a parameter. Icons start flashing to indicate the editing.
6. Press the  or  button to navigate between the options available for the selected parameter.
7. Press the  button to select the option or  button to abort the editing of current parameter. Flashing of icons stops after this.
8. Press the  or  button to navigate between parameters.
9. Press the  button to exit menu navigation.













UPS Settings

Configure UPS settings using the display interface. See “Configure UPS parameters” section to edit the parameters.

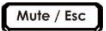
Function	Factory Default	User Selectable Options	Description
Output voltage	230 Vac	220, 230, 240 Vac	Allows the user to select output voltage while the UPS is operating online.
Audible alarm	Enable	Enable, disable	UPS will mute audible alarms when setting to disable or when the display panel MUTE button is pressed.
Green mode/ high efficiency mode	Disabled	Enable/Disable	When this mode is enabled, connected equipment receives utility input power through the bypass relay as long as input voltage is within the range of $\pm 5\%$ of configured output voltage and ± 4 Hz of configured output frequency. Inverter is turned off during this mode. If utility power input goes out of range, inverter is turned on. The load is transferred to online mode. The power to the connected equipment may be interrupted up to 10 milliseconds.
Battery Ah capacity	9 Ah	7~200 Ah	Allows the user to set the l Ah of the each battery connected to UPS.
Charging current	1 A	1 to 4 A	Set up charging current of the charger.
Output voltage adjustment	230 Vac	220 \pm 0~9 V 230 \pm 0~9 V 240 \pm 0~9 V	You may choose <input type="button" value="▲"/> or <input type="button" value="▼"/> to adjust Output voltage. This Parameter can set in Line Mode or Battery Mode.
Inverter voltage adjustment	Add 0	Add 000~09.9V Sub 000~09.9V	You may choose Add or Sub to adjust inverter voltage. The voltage range is from 0V to 9.9V and the default value is 0V. This Parameter can set in Line Mode or Battery Mode.

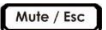

Advance Display Navigation



There are five options in main menu and two sub-menu options in UPS display. Press the  button from the Home Screen to access these menu options. Use the  or  button to navigate between the menu options.

Menu Option	Description						
SET	<p>Configure the UPS Use this menu option to configure the UPS parameters. Press the  button to see the configuration options. See “Configure UPS parameters” on page 16 for details. Press the  button to return to the Home Screen.</p>						
LOG	<p>Show Event Log Use this menu option to see the UPS event log. The UPS records the last 10 events and displays the codes in this log. Press the  button to see the log. Use the  or  button to see the logged events. The  button navigates towards old events and the  button navigates to new events. Every log entry has a numeric and textual event code. At the end of the log, the word “End” will be displayed. Press the  button to return to the Home Screen.</p>						
UPS	<p>Show UPS information Use this menu option to see the UPS information. Press the  button to see the rating of the UPS. Press the  button to see the UPS firmware version. Press the  button to return to the Home Screen.</p>						
bYP	<p>User Command to bypass Use this menu option to switch the UPS to bypass mode or bring the UPS to online mode from bypass mode. Press  button: <table style="margin-left: 20px;"> <tr> <td style="padding-right: 20px;">Put</td> <td>Put: Use to switch the UPS to bypass mode of operation.</td> </tr> <tr> <td></td> <td>Note: Power to the connected equipment will drop, if the mains voltage is not within the threshold limits.</td> </tr> <tr> <td>Out</td> <td>Out: Bring the UPS out of bypass and restore clean power to the connected equipment.</td> </tr> </table> </p>	Put	Put: Use to switch the UPS to bypass mode of operation.		Note: Power to the connected equipment will drop, if the mains voltage is not within the threshold limits.	Out	Out: Bring the UPS out of bypass and restore clean power to the connected equipment.
Put	Put: Use to switch the UPS to bypass mode of operation.						
	Note: Power to the connected equipment will drop, if the mains voltage is not within the threshold limits.						
Out	Out: Bring the UPS out of bypass and restore clean power to the connected equipment.						
tSt	<p>Execute Battery Self-Test Use this menu option to conduct a self-test and determine the battery status. Press the  button to initiate the test. If the test command is accepted, the UPS will initiate a self-test and will start a count down on the display. Display messages are shown at the end of the test.</p> <table style="margin-left: 20px;"> <tr> <td>rFd</td> <td>Test refused. The output is off or battery is not charged.</td> </tr> <tr> <td>FId</td> <td>Test not passed</td> </tr> <tr> <td>PAS</td> <td>Test passed</td> </tr> </table> <p>Press the  button to return to the Home Screen</p>	rFd	Test refused. The output is off or battery is not charged.	FId	Test not passed	PAS	Test passed
rFd	Test refused. The output is off or battery is not charged.						
FId	Test not passed						
PAS	Test passed						

Troubleshooting

Use the table below to solve minor installation and operation problems. Refer to the APC by Schneider Electric website, www.apc.com for assistance with complex UPS problems.

Problem and/or Possible Cause	Solution
UPS will not turn on when utility input is available or there is no power output	
The UPS is not turned on.	Press the  button to turn on the UPS.
The UPS is not connected to utility power supply.	Check that the power cable from the UPS to the utility power supply is securely connected at both ends. See “Start Up Settings” on page 7 in this manual.
Input thermal circuit breaker on the UPS is tripped.	Press the input thermal circuit breaker reset button in the rear panel.
The UPS is operating on battery, while connected to the input utility power	
There is high, low, or distorted input voltage or frequency.	Connect the UPS to a different outlet on a different circuit. Test the utility input power to ensure the unit is receiving input power. If display is on, navigate and check the input voltage and frequency.
UPS, when connected to battery, is not supplying power to the connected equipment	
The UPS is not turned on.	If the UPS has shutdown (the display is not on), follow the procedure “Cold start the UPS” on page 8.
The battery is not connected.	Connect battery to the UPS. See “Start Up Settings” on page 7 in this manual.
Low battery cut off. UPS may have discharged the battery due to utility power outage and turned the output off due to low battery condition.	Wait for the utility power to return and charge the battery. To turn on the output power after utility power returns, press  button.
UPS emits an audible beeping sound at long intervals	
The UPS is operating normally when running on battery.	UPS has detected an error. See “Alarms” on page 12 and “Notifications” on page 14 in this manual.
Alarm LED is illuminated. The UPS displays an alarm message and emits a constant beeping sound	
The UPS has detected an error.	See “Alarms” on page 12 and “Notifications” on page 14 in this manual.
No audible sounds from UPS even when the Alert LED is illuminated.	
Audible alarm is disabled.	Change the UPS configuration to enable audible alarms.
UPS is not providing expected backup time.	
The UPS battery is discharged due to a recent power outage.	The batteries require recharging after extended outages. Batteries can wear faster when put into service without proper recharging or when operated at elevated temperatures.
The battery is near the end of its service life.	If the battery is near the end of its service life, consider replacing the battery, even if the replace battery indicator is not illuminated. See “Start Up” on page 8 in this manual.

Problem and/or Possible Cause	Solution
UPS is not turning off	
POWER OFF button not pressed properly	Press and hold the  button until the beep is heard to power off the UPS.
Utility input power is available.	UPS logic power can not be turned off if utility input power is available. To turn off the UPS, turn off utility input power and press  button. Release when a beep is heard.
UPS is in Bypass mode and the LED is not illuminated red.	
UPS is in green mode.	Disable green mode if not desired.
UPS is configured to stay in the bypass mode.	Change the configuration to exit bypass mode.
UPS is in bypass mode even after over temperature alarm is cleared.	Reduce the connected load to <70% to bring the UPS to online mode.
The UPS has experienced an overload condition and transferred to bypass.	<p>Connected equipment exceeds the “maximum load” as defined in specifications on the APC by Schneider Electric Website, www.apc.com.</p> <p>The alarms remain on until the overload condition is corrected. Disconnect nonessential equipment from the UPS to eliminate the overload condition.</p> <p>The UPS continues to supply power as long as it is in bypass mode and the circuit breaker does not trip. The UPS will not provide battery power in the event of a utility voltage interruption.</p>
UPS detected an error and transferred to bypass.	See “Alarms” on page 12 and “Notifications” on page 14 in this manual.

Transport

1. Shut down and disconnect all connected equipment.
2. Disconnect the unit from mains power.
3. Disconnect all internal and external batteries (if applicable).
4. Follow the shipping instructions outlined in the *Service* section of this manual.

Service

If the unit requires service, do not return it to the dealer. Follow these steps:

1. Review the *Troubleshooting* section of the manual to eliminate common problems.
2. If the problem persists, contact APC by Schneider Electric Customer Support through the APC by Schneider Electric website, **www.apc.com**.
 - a. Note the model number and serial number and the date of purchase. The model and serial numbers are located on the rear panel of the unit and are available through the LCD display on select models.
 - b. Call Customer Support. A technician will attempt to solve the problem over the phone. If this is not possible, the technician will issue a Returned Material Authorization Number (RMA#).
 - c. If the unit is under warranty, the repairs are free.
 - d. Service procedures and returns may vary internationally. For country specific instructions refer to the APC by Schneider Electric website, **www.apc.com**.
3. Pack the unit properly to avoid damage in transit. Never use foam beads for packaging. Damage sustained in transit is not covered under warranty.
Note: Before shipping, always disconnect battery modules in a UPS or external battery pack. The disconnected internal batteries may remain inside the UPS or external battery pack.
4. Write the RMA# provided by Customer Support on the outside of the package.
5. Return the unit by insured, prepaid carrier to the address provided by Customer Support.

Limited Factory Warranty

Schneider Electric IT Corporation (SEIT), warrants its products to be free from defects in materials and workmanship for a period of two (2) years from the date of purchase. The SEIT obligation under this warranty is limited to repairing or replacing, at its own sole option, any such defective products. Repair or replacement of a defective product or part thereof does not extend the original warranty period.

This warranty applies only to the original purchaser who must have properly registered the product within 10 days of purchase. Products may be registered online at warranty.apc.com.

SEIT shall not be liable under the warranty if its testing and examination disclose that the alleged defect in the product does not exist or was caused by end user or any third person misuse, negligence, improper installation, testing, operation or use of the product contrary to SEIT recommendations of specifications. Further, SEIT shall not be liable for defects resulting from: 1) unauthorized attempts to repair or modify the product, 2) incorrect or inadequate electrical voltage or connection, 3) inappropriate on site operation conditions, 4) Acts of God, 5) exposure to the elements, or 6) theft. In no event shall SEIT have any liability under this warranty for any product where the serial number has been altered, defaced, or removed.

EXCEPT AS SET FORTH ABOVE, THERE ARE NO WARRANTIES, EXPRESS OR IMPLIED, BY OPERATION OF LAW OR OTHERWISE, APPLICABLE TO PRODUCTS SOLD, SERVICED OR FURNISHED UNDER THIS AGREEMENT OR IN CONNECTION HEREWITH.

SEIT DISCLAIMS ALL IMPLIED WARRANTIES OF MERCHANTABILITY, SATISFACTION AND FITNESS FOR A PARTICULAR PURPOSE.

SEIT EXPRESS WARRANTIES WILL NOT BE ENLARGED, DIMINISHED, OR AFFECTED BY AND NO OBLIGATION OR LIABILITY WILL ARISE OUT OF, SEIT RENDERING OF TECHNICAL OR OTHER ADVICE OR SERVICE IN CONNECTION WITH THE PRODUCTS.

THE FOREGOING WARRANTIES AND REMEDIES ARE EXCLUSIVE AND IN LIEU OF ALL OTHER WARRANTIES AND REMEDIES. THE WARRANTIES SET FORTH ABOVE CONSTITUTE SEIT'S SOLE LIABILITY AND PURCHASER EXCLUSIVE REMEDY FOR ANY BREACH OF SUCH WARRANTIES. SEIT WARRANTIES EXTEND ONLY TO ORIGINAL PURCHASER AND ARE NOT EXTENDED TO ANY THIRD PARTIES.

IN NO EVENT SHALL SEIT, ITS OFFICERS, DIRECTORS, AFFILIATES OR EMPLOYEES BE LIABLE FOR ANY FORM OF INDIRECT, SPECIAL, CONSEQUENTIAL OR PUNITIVE DAMAGES, ARISING OUT OF THE USE, SERVICE OR INSTALLATION OF THE PRODUCTS, WHETHER SUCH DAMAGES ARISE IN CONTRACT OR TORT, IRRESPECTIVE OF FAULT, NEGLIGENCE OR STRICT LIABILITY OR WHETHER SEIT HAS BEEN ADVISED IN ADVANCE OF THE POSSIBILITY OF SUCH DAMAGES. SPECIFICALLY, SEIT IS NOT LIABLE FOR ANY COSTS, SUCH AS LOST PROFITS OR REVENUE, WHETHER DIRECT OR INDIRECT, LOSS OF EQUIPMENT, LOSS OF USE OF EQUIPMENT, LOSS OF SOFTWARE, LOSS OF DATA, COSTS OF SUBSTITUANTS, CLAIMS BY THIRD PARTIES, OR OTHERWISE.

NOTHING IN THIS LIMITED WARRANTY SHALL SEEK TO EXCLUDE OR LIMIT SEIT LIABILITY FOR DEATH OR PERSONAL INJURY RESULTING FROM ITS NEGLIGENCE OR ITS FRAUDULENT MISREPRESENTATION OF TO THE EXTENT THAT IT CANNOT BE EXCLUDED OR LIMITED BY APPLICABLE LAW.

To obtain service under warranty you must obtain a Returned Material Authorization (RMA) number from customer support. Customers with warranty claims issues may access the SEIT worldwide customer support network through the APC by Schneider Electric website: www.apc.com. Select your country from the country selection drop down menu. Open the Support tab at the top of the web page to obtain information for customer support in your region. Products must be returned with transportation charges prepaid and must be accompanied by a brief description of the problem encountered and proof of date and place of purchase.

APC by Schneider Electric Worldwide Customer Support

Customer support for this or any other APC by Schneider Electric product is available at no charge in any of the following ways:

- Visit the APC by Schneider Electric website to access documents in the APC by Schneider Electric Knowledge Base and to submit customer support requests.
 - **www.apc.com** (Corporate Headquarters)
Connect to localized APC by Schneider Electric websites for specific countries, each of which provides customer support information.
 - **www.apc.com/support/**
Global support searching APC by Schneider Electric Knowledge Base and using e-support.
- Contact the APC by Schneider Electric Customer Support Center by telephone or e-mail.
 - Local, country specific centers: go to **www.apc.com/support/contact** for contact information.

For information on how to obtain local customer support, contact the APC by Schneider Electric representative or other distributor from whom you purchased your APC by Schneider Electric product.