

Cisco UCS C220 M7 SFF Rack Server

A printed version of this document is only a copy and not necessarily the latest version. Refer to the following link for the latest released version:

<https://www.cisco.com/c/en/us/products/servers-unified-computing/ucs-c-series-rack-servers/datasheet-listing.html>



CONTENTS

OVERVIEW	2
DETAILED VIEWS	4
Detailed Chassis Front View	4
Detailed Chassis Rear Views	5
One Half-Height Riser	6
Three Half-Height Risers	7
Two Full-Height Risers	8
BASE SERVER STANDARD CAPABILITIES and FEATURES	10
CONFIGURING the SERVER	14
STEP 1 SELECT SERVER SKU	15
STEP 2 SELECT RISERS (REQUIRED)	16
STEP 3 SELECT CPU(s) (REQUIRED)	18
STEP 4 SELECT MEMORY (REQUIRED)	22
Memory configurations and mixing rules	25
STEP 5 SELECT DRIVE CONTROLLERS (OPTIONAL)	27
RAID Volumes and Groups	27
STEP 6 SELECT DRIVES (OPTIONAL)	31
STEP 7 SELECT OPTION CARD(s) (OPTIONAL)	35
ORDER OPTIONAL PCIe OPTION CARD ACCESSORIES	37
STEP 8 ORDER GPU CARDS (OPTIONAL)	38
STEP 9 ORDER POWER SUPPLY (REQUIRED)	39
STEP 10 SELECT INPUT POWER CORD(s) (REQUIRED)	40
STEP 11 ORDER TOOL-LESS RAIL KIT (REQUIRED) AND REVERSIBLE CABLE MANAGEMENT ARM (OPTIONAL)	44
STEP 12 SELECT MANAGEMENT CONFIGURATION (OPTIONAL)	45
STEP 13 ORDER SECURITY DEVICES (REQUIRED)	46
STEP 14 SELECT LOCKING SECURITY BEZEL (OPTIONAL)	47
STEP 15 ORDER M.2 SATA SSDs (OPTIONAL)	48
STEP 16 ORDER M.2 NVMe AND RAID CONTROLLER(OPTIONAL)	49
STEP 17 SELECT OPERATING SYSTEM AND VALUE-ADDED SOFTWARE	50
STEP 18 CHOOSE OPTIONAL OPERATING SYSTEM MEDIA KIT	53
SUPPLEMENTAL MATERIAL	54
Block Diagrams	54
Chassis	56
Risers	58
Serial Port Details	61
KVM Cable	61
UPGRADING or REPLACING CPUs and Memory	62
SPARE PARTS	63
TECHNICAL SPECIFICATIONS	75
Dimensions and Weight	75
Power Specifications	76
Environmental Specifications	81
Extended Operating Temperature Hardware Configuration Limits	82
Compliance Requirements	83

OVERVIEW

The Cisco UCS C220 M7 SFF server extends the capabilities of Cisco's Unified Computing System portfolio in a 1U form factor with the 4th Gen Intel® Xeon® Scalable Processors (codenamed Sapphire Rapids), 16 DIMM slots per CPU for DDR5-4800 Memory DIMMs with DIMM capacity points up to 128GB.

The Cisco UCS C220 M7 server harnesses the power of the latest 4th Gen Intel® Xeon® Scalable Processors (codenamed Sapphire Rapids), and offers the following:

CPU: Up to 2x 4th Gen Intel® Xeon® Scalable Processors (codenamed Sapphire Rapids) with up to 52 cores per processor.

Memory: Up to 4TB with 32 x 128GB DDR5-4800 DIMMs, in a 2-socket configuration.

The server provides an internal slot for one of the following:

- SATA Interposer to control SATA drives from the PCH (AHCI) or
- Cisco 24G Tri-mode RAID controller¹ with cache backup to control SAS/SATA/NVMe drives or
- Cisco 12G RAID controller with cache backup to control SAS/SATA drives or
- Cisco 12G SAS pass-through HBA to control SAS/SATA drives

mLOM: The UCS C220 M7 SFF server has a single 1GBE management port. A modular LAN on motherboard (mLOM)/OCP 3.0 module provides up to two 100GBE ports. A connector on the front of the chassis provides KVM functionality.

There are several options to choose from:

- **Option 1 UCSC-C220-M7S** (see [Figure 1 on page 3](#)):
 - Drive bays 1-10 supports up to 10 front facing SFF SAS/SATA HDDs/SSDs or NVMe SSDs with hardware raid (optionally up to 4 of the slots can be direct-attach NVMe).
 - One to three half-height PCIe risers or one to two full-height PCIe risers
- **Option 2 UCSC-C220-M7N** (see [Figure 1 on page 3](#)):
 - Drive bays 1 - 10 support only NVMe PCIe drives.
 - One to three half-height PCIe risers, or one to two full-height PCIe risers

The Cisco UCS C220 M7 SFF server can be used standalone, or as part of the Cisco Unified Computing System, which unifies computing, networking, management, virtualization, and storage access into a single integrated architecture, enabling end-to-end server visibility, management, and control in both bare metal and virtualized environments.

See [Figure 1 on page 3](#) for front and rear views of the UCS C220 M7 server.

Notes . . .

1. Available post first customer ship (FCS)

Figure 1 Cisco UCS C220 M7 SFF Rack Server

Front View



Rear View (one half-height riser card version)



Rear View (three half-height riser card version)



Rear View (two full-height riser card version - shown with riser blanks installed)



DETAILED VIEWS

Detailed Chassis Front View

Figure 2 shows the detailed front view of the Cisco UCS C220 M7 SFF Rack Server

Figure 2 Detailed Chassis Front View

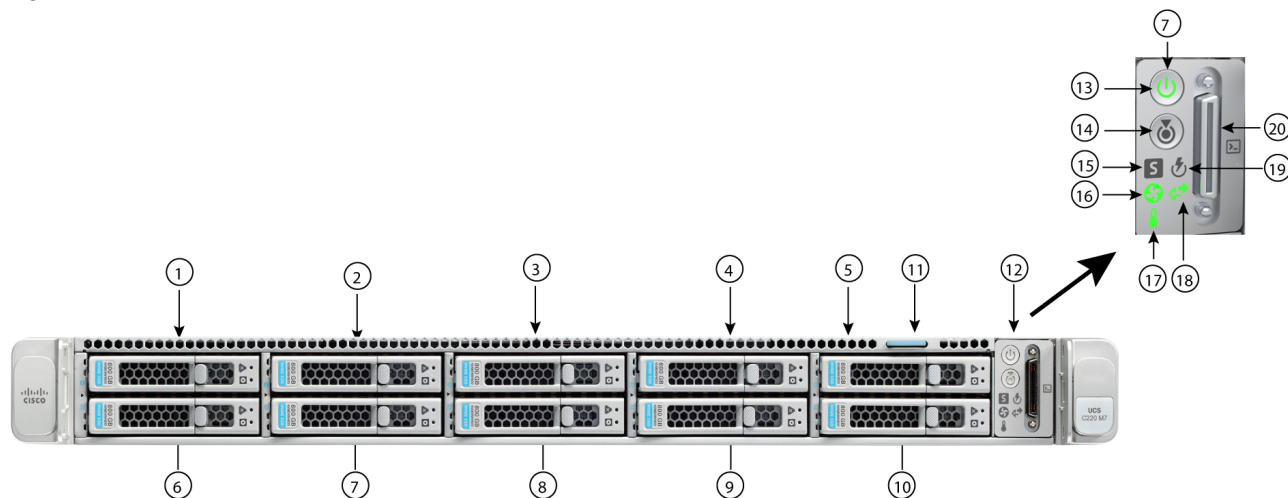

1 - 4	<p>Option 1 UCSC-C220-M7S</p> <ul style="list-style-type: none"> ■ Drive bays 1 - 4 support SAS/SATA hard drives and solid state drives (SSDs) or NVMe PCIe drives.^{1,2} <p>Option 2 UCSC-C220-M7N³</p> <ul style="list-style-type: none"> ■ Drive bays 1 - 4 support only NVMe PCIe drives 	15	System status LED
5 - 10	<p>Option 1 UCSC-C220-M7S</p> <ul style="list-style-type: none"> ■ Drive bays 5 - 10 support SAS/SATA hard drives and solid state drives (SSDs) only <p>Option 2 UCSC-C220-M7N³</p> <ul style="list-style-type: none"> ■ Drive bays 5 - 10 support NVMe PCIe drives only. 	16	Fan status LED
11	Asset tag location	17	Temperature status LED
12	Control panel	18	Network link activity LED
13	Power button/power status LED	19	Power supply status LED
14	Unit Identification button/LED	20	KVM connector (used with KVM cable that provides two USB 2.0, one VGA, and one serial connector)

Notes:

1. You can mix and match in drive bays 1 - 4. For example, slots 1 and 2 can hold NVMe drives and slots 3 and 4 can hold SAS/SATA HDDs or SSDs.
2. If using a SATA Interposer board, up to a maximum of 8 SATA-only drives can be configured (slots 1-4 and 6-9 only)
3. Two CPUs are required with all NVMe (UCSC-C220-M7N) server.

Detailed Chassis Rear Views

Figure 3 shows the details of the rear panel for the UCS C220 M7 with one rear half-height PCIe riser.

Figure 4 shows the details of the rear panel for the UCS C220 M7 with three rear half-height PCIe risers.

Figure 5 shows the details of the rear panel for the UCS C220 M7 with two rear full-height PCIe risers.

One Half-Height Riser



NOTE: 1-CPU servers support 1 and 2 half-height risers. 2-CPU servers support all three half-height risers.

Figure 3 Chassis Rear View (one half-height, 3/4 length PCIe riser)

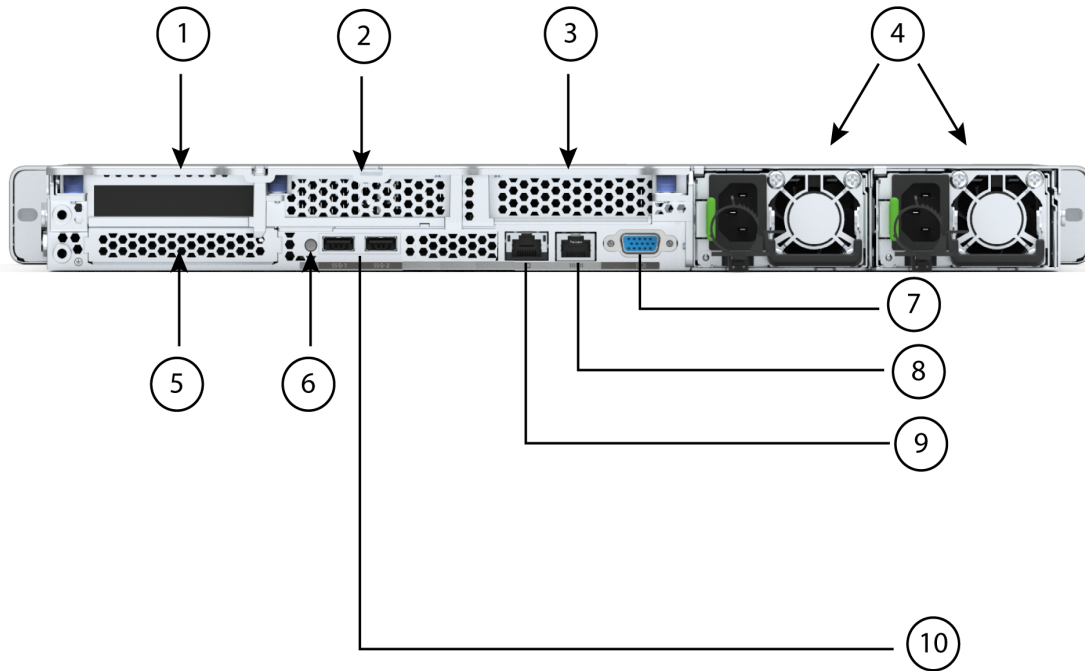

1	<p>There are two half height riser 1 options:</p> <p>Riser 1A PCIe Gen4 (CPU1 control)</p> <ul style="list-style-type: none"> ■ Supports one PCIe slot (slot 1) ■ Slot 1 is half-height, 3/4 length, x16, NCSI, Single Wide GPU <p>Riser 1B PCIe Gen5 (CPU1 control)</p> <ul style="list-style-type: none"> ■ Supports one PCIe slot (slot 1) ■ Slot 1 is half-height, 3/4 length, x16, NCSI, Single Wide GPU 	6	System ID pushbutton/LED
2	Riser 2 blanking panel	7	VGA display port (DB15 connector)
3	Riser 3 blanking panel	8	COM port (RJ45 connector)
4	Power supplies (two, redundant as 1+1)	9	1GBE dedicated Ethernet management port
5	Modular LAN on motherboard (mLOM)/OCP 3.0 slot	10	USB 3.0 ports (two)

Three Half-Height Risers



NOTE:

- Only 2-CPU servers support all three half-height risers.
- Gen4 and Gen5 risers cannot be mixed.

Figure 4 Chassis Rear View (three half-height, 3/4 length PCIe risers)

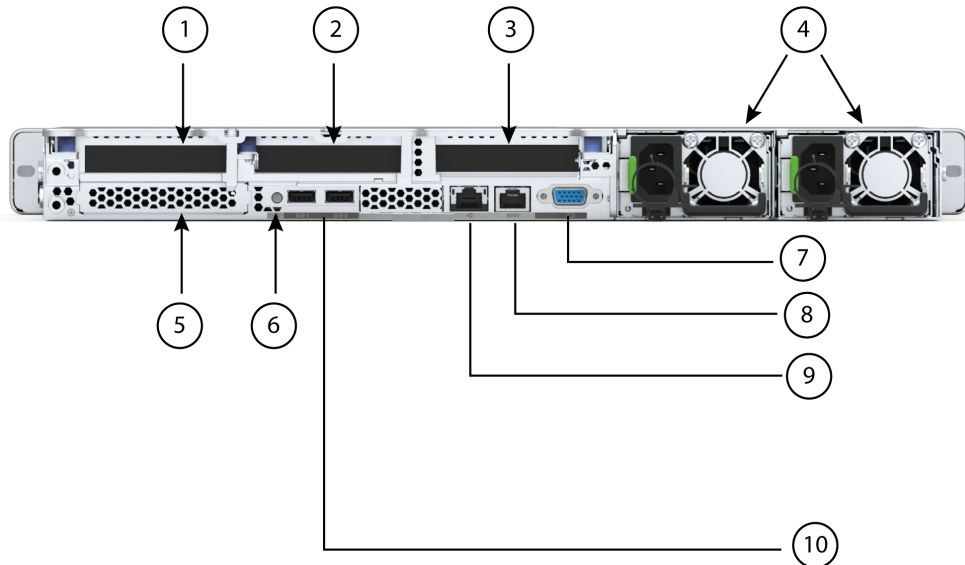

<p>1</p>	<p>There are two half height riser 1 options:</p> <p>Riser 1A PCIe Gen4 (CPU1 control)</p> <ul style="list-style-type: none"> ■ Supports one PCIe slot (slot 1) ■ Slot 1 is half-height, 3/4 length, x16, NCSI, Single Wide GPU <p>Riser 1B PCIe Gen5 (CPU1 control)</p> <ul style="list-style-type: none"> ■ Supports one PCIe slot (slot 1) ■ Slot 1 is half-height, 3/4 length, x16, NCSI, Single Wide GPU 	<p>6</p>	<p>System ID pushbutton/LED</p>
<p>2</p>	<p>There are two half height riser 2 options:</p> <p>Riser 2A PCIe Gen4 x16 (CPU1 control)</p> <ul style="list-style-type: none"> ■ Supports one PCIe slot (slot 2) ■ Slot 2 is half-height, 3/4 length, x16, Single Wide GPU <p>Riser 2B PCIe Gen5 x16 (CPU1 control)</p> <ul style="list-style-type: none"> ■ Supports one PCIe slot (slot 2) ■ Slot 2 is half-height, 3/4 length, x16, Single Wide GPU 	<p>7</p>	<p>VGA display port (DB15 connector)</p>

3	There is one half height riser 3 option: Riser 3A PCIe Gen4 x16 (CPU2 control) <ul style="list-style-type: none"> ■ Supports one PCIe slot (slot 3) ■ Slot 3 is half-height, 3/4 length, x16, NCSI, Single Wide GPU 	8	COM port (RJ45 connector)
4	Power supplies (two, redundant as 1+1)	9	1GBE dedicated Ethernet management port
5	Modular LAN on motherboard (mLOM)/OCP 3.0 slot	10	USB 3.0 ports (two)

Two Full-Height Risers



NOTE: 1-CPU servers support only full-height riser 1 while 2-CPU servers support both full-height risers.

Figure 5 Chassis Rear View (two full-height, 3/4-length PCIe risers)

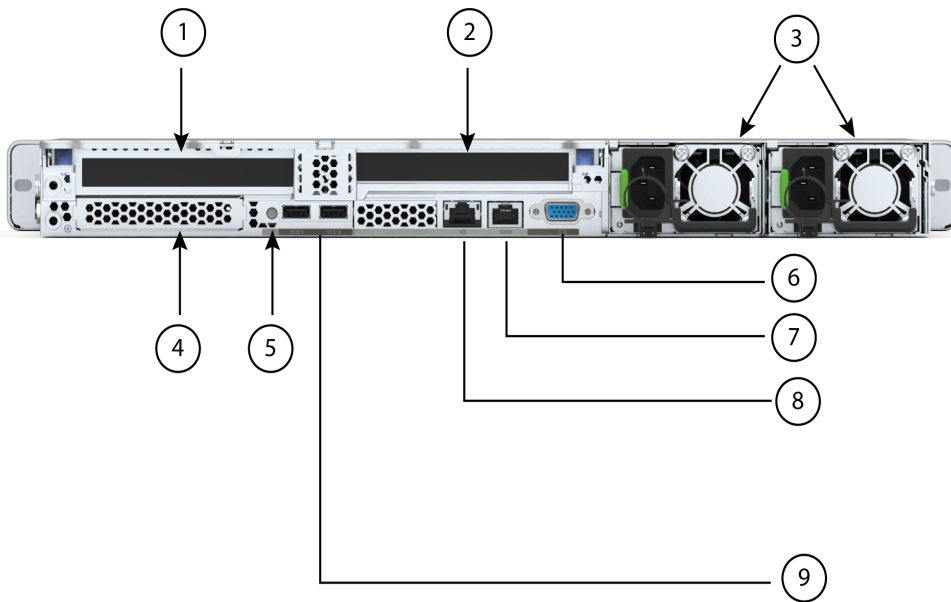

DETAILED VIEWS

1	Riser 1C PCIe Gen5 (CPU1 control) <ul style="list-style-type: none">■ Supports one PCIe slot (slot 1)■ Slot 1 is full-height, 3/4 length, x16, NCSI, Single Wide GPU	6	VGA display port (DB15 connector)
2	Riser 3C PCIe Gen5 x16 (CPU2 control) <ul style="list-style-type: none">■ Supports one PCIe slot (slot 3)■ Slot 3 is Full-height, 3/4 length, x16, NCSI, Single Wide GPU	7	COM port (RJ45 connector)
3	Power supplies (two, redundant as 1+1)	8	1GBE dedicated Ethernet management port
4	Modular LAN on motherboard (mLOM)/OCP 3.0 slot	9	USB 3.0 ports (two)
5	System ID pushbutton/LED	-	-

BASE SERVER STANDARD CAPABILITIES and FEATURES

Table 1 lists the capabilities and features of the base server. Details about how to configure the server for a particular feature or capability (for example, number of processors, disk drives, or amount of memory) are provided in *CONFIGURING the SERVER, page 14*.

Table 1 Capabilities and Features

Capability/Feature	Description
Chassis	One rack unit (1RU) chassis
CPU	<ul style="list-style-type: none"> ■ One or two 4th Gen Intel® Xeon® Scalable Processors (codenamed Sapphire Rapids) ■ Each CPU has 8 channels with up to 2 DIMMs per channel, for up to 16 DIMMs per CPU ■ UPI Links: Up to 3 at 16GT/s
Chipset	Intel® C741 series chipset
Memory	<ul style="list-style-type: none"> ■ 32 total DDR5-4800 MT/s DIMM slots (16 per CPU) ■ 50% peak bandwidth increase over DDR4-3200, with on-die ECC; all densities are Registered DIMMs (RDIMMs) ■ Up to 4TB DDR5-4800 DIMM memory capacity (32x 128GB DIMMs)
Video	<p>The Cisco Integrated Management Controller (CIMC) provides video using the Matrox G200e video/graphics controller:</p> <ul style="list-style-type: none"> ■ Integrated 2D graphics core with hardware acceleration ■ Embedded DDR memory interface supports up to 512 MB of addressable memory (8 MB is allocated by default to video memory) ■ Supports display resolutions up to 1920 x 1200 16bpp @ 60Hz ■ High-speed integrated 24-bit RAMDAC ■ Single lane PCI-Express host interface running at Gen 1 speed
Power subsystem	<p>Up to two of the following hot-swappable power supplies:</p> <ul style="list-style-type: none"> ■ 770 W (AC) ■ 1200W (AC) ■ 1600 W (AC) ■ 2300 W (AC) <p>One power supply is mandatory; one more can be added for 1 + 1 redundancy.</p>
Front Panel	A front panel controller provides status indications and control buttons
ACPI	This server supports the advanced configuration and power interface (ACPI) 6.2 standard.
Fans	Eight hot-swappable fans for front-to-rear cooling
Infiniband	The InfiniBand architecture is supported by the PCI slots.

Table 1 Capabilities and Features (continued)

Capability/Feature	Description
Expansion slots	<ul style="list-style-type: none"> ■ Half-height riser slots (select up to three) <ul style="list-style-type: none"> • Riser 1A PCIe Gen4 x16 HH • Riser 1B PCIe Gen5 x16 HH • Riser 2A PCIe Gen4 x16 HH • Riser 2B PCIe Gen5 x16 HH • Riser 3A PCIe Gen4 x16 HH (CPU2 Control) ■ Full-height riser slots (select up to two) <ul style="list-style-type: none"> • Riser 1C PCIe Gen5 x16 FH • Riser 3C PCIe Gen5 x16 FH (CPU2 Control)
Interfaces	<ul style="list-style-type: none"> ■ Rear panel <ul style="list-style-type: none"> • One 1Gbase-T RJ-45 management port • One RS-232 serial port (RJ45 connector) • One DB15 VGA connector • Two USB 3.0 port connectors • One flexible modular LAN on motherboard (mLOM/OCP 3.0) slot that can accommodate various interface cards ■ Front panel <ul style="list-style-type: none"> • One KVM console connector (supplies two USB 2.0 connectors, one VGA DB15 video connector, and one serial port (RS232) RJ45 connector)
Integrated management processor	<p>Baseboard Management Controller (BMC) running Cisco Integrated Management Controller (CIMC) firmware.</p> <p>Depending on your CIMC settings, the CIMC can be accessed through the 1GE dedicated management port. Cisco virtual interface card (VIC).</p> <p>CIMC manages certain components within the server, such as the Cisco 12G SAS HBA.</p>

Table 1 Capabilities and Features (continued)

Capability/Feature	Description
Internal storage devices	<p>Drive storage:</p> <p>Drives are installed into front-panel drive bays, which provide hot-swappable access for SAS/SATA or NVMe drives. The server is orderable in two different versions:</p> <ul style="list-style-type: none"> ■ UCSC-C220-M7S (option 1): <ul style="list-style-type: none"> • Up to 10 SFF SAS/SATA hard drives (HDDs) or SAS/SATA/NVMe solid state drives (SSDs). • Optionally, up to four direct-attach SFF NVMe PCIe SSDs. These drives must be placed in front drive bays 1, 2, 3, and 4 only, can be mixed with SAS/SATA drives, and are controlled from CPU 2. The rest of the bays (5 - 10) can be populated with SAS/SATA/NVMe SSDs or HDDs. Two CPUs are required when choosing direct-attach NVMe SSDs. • If using a SATA Interposer, up to 8 SATA-only drives can be installed (slots 1-4 and 6-9 only). ■ UCSC-C220-M7N (option 2): <ul style="list-style-type: none"> • Up to 10 2.5-inch direct-attach NVMe SSDs. only. • The drives in slots 1, 2, 3, 4, 6, and 7 are connected to CPU 2 and the drives in slots 5, 8, 9, and 10 are connected to CPU1. Up to 4 drives are allowed with single CPU configuration and can only be installed in slots 5, 8, 9, and 10. <p>Other storage:</p> <ul style="list-style-type: none"> ■ A mini-storage module connector on the motherboard supports a boot-optimized RAID controller carrier that holds up to two SATA M.2 SSDs. ■ 8GB FlexMMC utility storage for staging of firmware and other user data. 8GB FlexMMC storage is built into the motherboard on M7.

Table 1 Capabilities and Features (continued)

Capability/Feature	Description
Storage controllers	<p>Internal storage controllers:</p> <p>The SATA Interposer board, 24G Tri-mode RAID controller, 12G RAID controller or 12G SAS HBA. Only one of these at a time can be used.</p> <ul style="list-style-type: none"> ■ SATA Interposer board <ul style="list-style-type: none"> • AHCI support up to eight SATA-only drives (slots 1-8) ■ Cisco 24G Tri-mode RAID controller¹ <ul style="list-style-type: none"> • RAID support (RAID 0, 1, 5, 6, 10, 50, 60, RAID0, and RAID00) • Supports up to 10 internal SAS/SATA/NVMe drives ■ Cisco 12G RAID controller <ul style="list-style-type: none"> • RAID support (RAID 0, 1, 5, 6, 10, 50, 60, RAID0, and RAID00) • Supports up to 10 internal SAS/SATA drives ■ Cisco 12G SAS HBA <ul style="list-style-type: none"> • No RAID support • JBOD/Pass-through Mode support • Supports up to 10 SAS/SATA internal drives <p>External storage controllers:</p> <ul style="list-style-type: none"> ■ Cisco 12G 9500-8e 12G SAS HBA for external JBOD attach
Modular LAN on Motherboard (mLOM)/ Open Compute Project (OCP) 3.0 slot	<p>The dedicated mLOM/Open Compute Project (OCP) 3.0 slot on the motherboard can flexibly accommodate the following cards:</p> <ul style="list-style-type: none"> ■ Cisco Virtual Interface Cards ■ Open Compute Project (OCP) 3.0 network interface card
UCSM ¹	UCS Manager (UCSM) 4.3(2) or later runs in the Fabric Interconnect and automatically discovers and provisions some of the server components.
CIMC	Cisco Integrated Management Controller 4.3(1) or later
Intersight	Intersight provides server management capabilities

Notes:

1. Available post first customer ship (FCS)

CONFIGURING the SERVER

Follow these steps to configure the Cisco UCS C220 M7 SFF Rack Server:

- *STEP 1 SELECT SERVER SKU, page 15*
- *STEP 2 SELECT RISERS (REQUIRED), page 16*
- *STEP 3 SELECT CPU(s) (REQUIRED), page 18*
- *STEP 4 SELECT MEMORY (REQUIRED), page 22*
- *STEP 5 SELECT DRIVE CONTROLLERS (OPTIONAL), page 27*
- *STEP 6 SELECT DRIVES (OPTIONAL), page 31*
- *STEP 7 SELECT OPTION CARD(s) (OPTIONAL), page 35*
- *STEP 8 ORDER GPU CARDS (OPTIONAL), page 38*
- *STEP 9 ORDER POWER SUPPLY (REQUIRED), page 39*
- *STEP 10 SELECT INPUT POWER CORD(s) (REQUIRED), page 40*
- *STEP 11 ORDER TOOL-LESS RAIL KIT (REQUIRED) AND REVERSIBLE CABLE MANAGEMENT ARM (OPTIONAL), page 44*
- *STEP 12 SELECT MANAGEMENT CONFIGURATION (OPTIONAL), page 45*
- *STEP 13 ORDER SECURITY DEVICES (REQUIRED), page 46*
- *STEP 14 SELECT LOCKING SECURITY BEZEL (OPTIONAL), page 47*
- *STEP 15 ORDER M.2 SATA SSDs (OPTIONAL), page 48*
- *STEP 16 ORDER M.2 NVMe AND RAID CONTROLLER(OPTIONAL), page 49*
- *STEP 18 CHOOSE OPTIONAL OPERATING SYSTEM MEDIA KIT, page 53*
- *SUPPLEMENTAL MATERIAL, page 54*

STEP 1 SELECT SERVER SKU

Top level ordering product ID (PID) is shown in [Table 2](#).

Table 2 Top level ordering PID (Major Line Bundle)

Product ID (PID)	Description
UCS-M7-MLB	UCS M7 RACK, BLADE MLB This major line bundle (MLB) consists of the Rack Server (UCSC-C220-M7S or UCSC-C220-M7N) with software PIDs. Use this PID to begin a new configuration.

Select one product ID (PID) as shown in [Table 3](#).



CAUTION: This product may not be purchased outside of the approved bundles (must be ordered under the MLB)

Table 3 PID of the C220 M7 SFF Rack Base Server

Product ID (PID)	Description
UCSC-C220-M7S (option 1)	Small form-factor (SFF) drives, with 10-drive backplane. <ul style="list-style-type: none"> ■ Front facing drive bays 1-10 support 2.5in SAS/SATA/NVMe SSDs depending on controller type installed. ■ Optionally, front-loading drive bays 1, 2, 3, and 4 support 2.5-inch direct-attach NVMe SSDs and the rest can be SAS/SATA HDDs or SSDs.
UCSC-C220-M7N (option 2)	Small form-factor (SFF) drives, with 10-drive backplane. <ul style="list-style-type: none"> ■ Front-loading drive bays 1–10 support 2.5-inch NVMe SSDs (only) drives.

The Cisco UCS C220 M7 SFF Server:

- Includes a 10 drive backplane.
- Does not include power supply, CPU, memory, hard disk drives (HDDs), solid-state drives (SSDs), NVMe drives, SD cards, riser 1, riser 2, riser 3, tool-less rail kit, or PCIe cards.
- Use the steps on the following pages to configure the server with the components that you want to include.

STEP 2 SELECT RISERS (REQUIRED)

The riser PIDs are listed in [Table 4](#).



CAUTION:

- Full-height risers cannot be mixed with half-height risers.
- Gen4 and Gen5 risers cannot be mixed.

Table 4 PIDs of the Risers and Riser Blanks

Product ID (PID)	Description
Riser 1 Option	
UCSC-RIS1A-22XM7	UCS C-Series M7 1U Riser 1A PCIe Gen4 x16 HH <ul style="list-style-type: none"> ■ Half-height riser 1 (controlled by CPU 1) ■ One x16 PCIe Gen4 riser, standard PCIe, supports Cisco VIC, half-height, 3/4 length
UCSC-RIS1B-22XM7	UCS C-Series M7 1U Riser 1B PCIe Gen5 x16 HH <ul style="list-style-type: none"> ■ Half-height riser 1 (controlled by CPU 1) ■ One x16 PCIe Gen5 riser, standard PCIe, supports Cisco VIC, half-height, 3/4 length
UCSC-RIS1C-22XM7	UCS C-Series M7 1U Riser 1C PCIe Gen5 x16 FH <ul style="list-style-type: none"> ■ Full-height riser 1 (controlled by CPU 2) ■ One x16 PCIe Gen5 riser, standard PCIe, supports Cisco VIC, half-height, 3/4 length
Riser 2 Option	
UCSC-RIS2A-22XM7	UCS C-Series M7 1U Riser 2A PCIe Gen4 x16 HH <ul style="list-style-type: none"> ■ Half-height riser 1 (controlled by CPU 1) ■ One x16 PCIe Gen4 riser, standard PCIe, half-height, 3/4 length
UCSC-RIS2B-22XM7	UCS C-Series M7 1U Riser 2B PCIe Gen5 x16 HH <ul style="list-style-type: none"> ■ Half-height riser 1 (controlled by CPU1) ■ One x16 PCIe Gen5 riser, standard PCIe, half-height, 3/4 length
Riser 3 Option	
UCSC-RIS3A-22XM7	UCS C-Series M7 1U Riser 3A PCIe Gen4 x16 HH (CPU2) <ul style="list-style-type: none"> ■ Half-height riser 1 (controlled by CPU 2) ■ One x16 PCIe Gen4 riser, standard PCIe, supports Cisco VIC, half-height, 3/4 length
UCSC-RIS3C-22XM7	UCS C-Series M7 1U Riser 3C PCIe Gen5 x16 FH (CPU2) <ul style="list-style-type: none"> ■ Full-height riser 1 (controlled by CPU 2) ■ One x16 PCIe Gen5 riser, standard PCIe, supports Cisco VIC, half-height, 3/4 length
Accessories/spare included along with selected risers:	
<ul style="list-style-type: none"> ■ UCSC-FBRS2-C220M7 for riser 2 and UCSC-FBRS-C220-D riser filler blank for riser 3 is auto included, if riser 2 or riser 3 are not selected. UCSC-FBRSF-220M7 is auto included if only one full height riser is selected 	

Approved Configurations

- (1) Half-height riser 1A, 2A, and 3A only. riser 1A and 2A are controlled from CPU1 and Riser 3 is controlled from CPU2.
- (2) Half-height risers 1B, 2B, and 3A only. Risers 1B and 2B are controlled from CPU1 and Riser 3A is controlled from CPU2
- (3) Full-height risers 1C and 3C only. Riser 1C is controlled from CPU1 and riser 3C is controlled from CPU2.

STEP 3 SELECT CPU(s) (REQUIRED)

The standard CPU features are:

- The 4th Gen Intel® Xeon® Scalable Processors (codenamed Sapphire Rapids) are paired with Intel® C741 series chipset
- Up to 52 cores
- Cache size of up to 105 MB
- Power: Up to 300Watts
- UPI Links: Up to 3 at 16GT/s

Select CPUs

The available CPUs are listed in [Table 5](#). See [Table 6 on page 20](#) for CPU suffix notations.



CAUTION: Normal operating temperature is limited to 35° C [95° F], for the 2U NVMe/SAS SKU, and is lowered to 28° C [82.4° F], with a fan fault.

Table 5 Available CPUs

Product ID (PID)	Segment/Workload	Maximum Socket (S)	Cores (C)	Clock Freq (GHz)	Power (W)	Cache Size (MB)	Highest DDR5 DIMM Clock Support (MT/s)
8000 Series Processors							
UCS-CPU-I8471N	5G/Networking	1S	52	1.80	300	97.50	4800
UCS-CPU-I8470N	5G/Networking	2S	52	1.70	300	97.50	4800
UCS-CPU-I8462Y+	2S Performance	2S	32	2.80	300	60.00	4800
UCS-CPU-I8461V	Cloud/SaaS/Media	1S	48	2.20	300	97.50	4800
UCS-CPU-I8460Y+	2S Performance	2S	40	2.00	300	105.00	4800
UCS-CPU-I8454H	IMDB/Analytics	2S	32	2.10	270	82.50	4800
UCS-CPU-I8452Y	2S Mainline	2S	36	2.00	300	67.50	4800
UCS-CPU-I8450H	IMDB/Analytics	2S	28	2.00	250	75.00	4800
UCS-CPU-I8444H	IMDB/Analytics	2S	16	2.90	270	45.00	4800
6000 Series Processors							
UCS-CPU-I6454S	Storage	2S	32	2.20	270	60.00	4800
UCS-CPU-I6448Y	2S Performance	2S	32	2.10	225	60.00	4800
UCS-CPU-I6448H	IMDB/Analytics	2S	32	2.40	250	60.00	4800
UCS-CPU-I6444Y	2S Performance	2S	16	3.60	270	45.00	4800

Table 5 Available CPUs

Product ID (PID)	Segment/Workload	Maximum Socket (S)	Cores (C)	Clock Freq (GHz)	Power (W)	Cache Size (MB)	Highest DDR5 DIMM Clock Support (MT/s)
UCS-CPU-I6442Y	2S Performance	2S	24	2.60	225	60.00	4800
UCS-CPU-I6438Y+	2S Mainline	2S	32	2.00	205	60.00	4800
UCS-CPU-I6438N	5G/Networking	2S	32	2.00	205	60.00	4800
UCS-CPU-I6438M	Cloud/SaaS/Media	2S	32	2.20	205	60.00	4800
UCS-CPU-I6434H	IMDB/Analytics	2S	8	3.70	195	22.50	4800
UCS-CPU-I6434	2S Performance	2S	8	3.70	195	22.50	4800
UCS-CPU-I6430	2S Mainline	2S	32	2.10	270	60.00	4400
UCS-CPU-I6428N	5G/Networking	2S	32	1.80	185	60.00	4000
UCS-CPU-I6426Y	2S Performance	2S	16	2.50	185	37.50	4800
UCS-CPU-I6421N	5G/Networking	1S	32	1.80	185	60.00	4400
UCS-CPU-I6418H	IMDB/Analytics	2S	24	2.10	185	60.00	4800
UCS-CPU-I6416H	IMDB/Analytics	2S	18	2.20	165	45.00	4800
UCS-CPU-I6414U	1S gen. purpose	1S	32	2.00	250	60.00	4800
5000 Series Processors							
UCS-CPU-I5420+	2S Mainline	2S	28	2.00	205	52.50	4400
UCS-CPU-I5418Y	2S Mainline	2S	24	2.00	185	45.00	4400
UCS-CPU-I5418N	5G/Networking	2S	24	1.80	165	45.00	4000
UCS-CPU-I5416S	Storage	2S	16	2.00	150	30.00	4400
UCS-CPU-I5415+	2S Performance	2S	8	2.90	150	22.50	4400
UCS-CPU-I5412U	1S gen. purpose	1S	24	2.10	185	45.00	4400
UCS-CPU-I5411N	5G/Networking	1S	24	1.90	165	45.00	4400
4000 Series Processors							
UCS-CPU-I4416+	2S Mainline	2S	20	2.00	165	37.50	4000
UCS-CPU-I4410Y	2S Mainline	2S	12	2.00	150	30.00	4000
UCS-CPU-I4410T	IOT	2S	10	2.70	150	26.25	4000
3000 Series Processors							
UCS-CPU-I3408U	1S gen. purpose	1S	8	1.80	125	22.50	4000
Accessories/spare included with CPU configuration:							
<ul style="list-style-type: none"> ■ UCSC-HSLP-C220M7 							
Please note, if you are adding a second CPU later, you may need to order accessories with it.							

Table 6 CPU Suffixes

CPU Suffix	Description	Features
P	Cloud (IaaS)	Designed for cloud IaaS environments to deliver higher frequencies at constrained TDPs
V	Cloud (SaaS)	Designed for high rack density, maximize VM/core, and lower power VM environment
M	Media Transcode	Designed for Media processing, AI, and HPC workloads
H	DB and Analytics	Designed for Data Analytics and Big Data usages
N	Network/5G/Edge (High TDP/Low latency)	Designed and optimized for a range of broadly-deployed network and 5G workload environments from Edge to the Data Center
S	Storage & HCI	Designed for Storage usages and workloads
T	Long-life Use/High Tcase	Designed for Network Environment-Building System (NEBS) and IoT market
U	1-Socket	Optimized for targeted platforms adequately served by the cores, memory bandwidth and IO capacity available from a single processor
Y	General SKU with SST-PP	Designator is used for general SKU stack to highlight SST-PP (Speed Select Technology Performance Profile) feature enabled
+	Feature Plus SKU	Designed to enable 1 instance of each DSA, IAA, QAT, DLB embedded accelerator

Supported Configurations

- For 1-CPU systems, the server can support up to:
 - two half-height risers 1 and 2, or
 - one full-height riser 1
- For 2-CPU systems, the server can support up to:
 - three half-height risers 1, 2, and 3, or
 - two full-height risers 1 and 2,
- For the UCSC-C220-M7S:
 - 2 CPUs are required if direct-attach NVMe drives are selected
- For the UCSC-C220-M7N:
 - Select one or two identical CPUs listed in [Table 5 on page 18](#)
 - Up to 4 drives are allowed with 1-CPU configuration and can only be installed in slots 5, 8, 9, and 10.

**NOTE:**

- You cannot have two I8471N, or two I8461V, two I6421N, two I6414U, two I5412U, two I5411N or two I3408U CPUs in a two-CPU configuration.
 - If you configure a server with one I8471N, or one I8461V, one I6421N, one I6414U, one I5412U, one I5411N or one I3408U CPU you cannot later upgrade to a 2-CPU system with two of these CPUs.
-

The selection of 1 or 2 CPUs depends on the desired server functionality. See the following sections:

- [STEP 4 SELECT MEMORY \(REQUIRED\), page 22](#)
- [STEP 5 SELECT DRIVE CONTROLLERS \(OPTIONAL\), page 27](#)
- [STEP 6 SELECT DRIVES \(OPTIONAL\), page 31](#)
- [STEP 7 SELECT OPTION CARD\(s\) \(OPTIONAL\), page 35](#)

STEP 4 SELECT MEMORY (REQUIRED)

The [Table 7](#) below describes the main memory DIMM features supported on Cisco UCS C220 M7 Rack server.

Table 7 Main Memory Features

Memory DIMM server technologies	Description
Maximum DDR5 memory clock speed	Up to 4800MT/s 1DPC; Up to 4400MT/S 2DPC
Operational voltage	1.1 Volts
DRAM Fab. density	16Gb
DRAM DIMM type	RDIMM (Registered DDR5 DIMM with on die ECC)
Memory DIMM organization	Eight memory DIMM channels per CPU; up to 2 DIMMs per channel
Maximum number of DRAM DIMM per server	32 (2-Socket)
DRAM DIMM densities and ranks	16GB 1Rx8, 32GB 1Rx4, 64GB 2Rx4, 128GB 4Rx4
Maximum system capacity (DRAM DIMMs only)	4TB (32x 128GB)

Figure 6 Cisco UCS 220 M7 Memory Organization

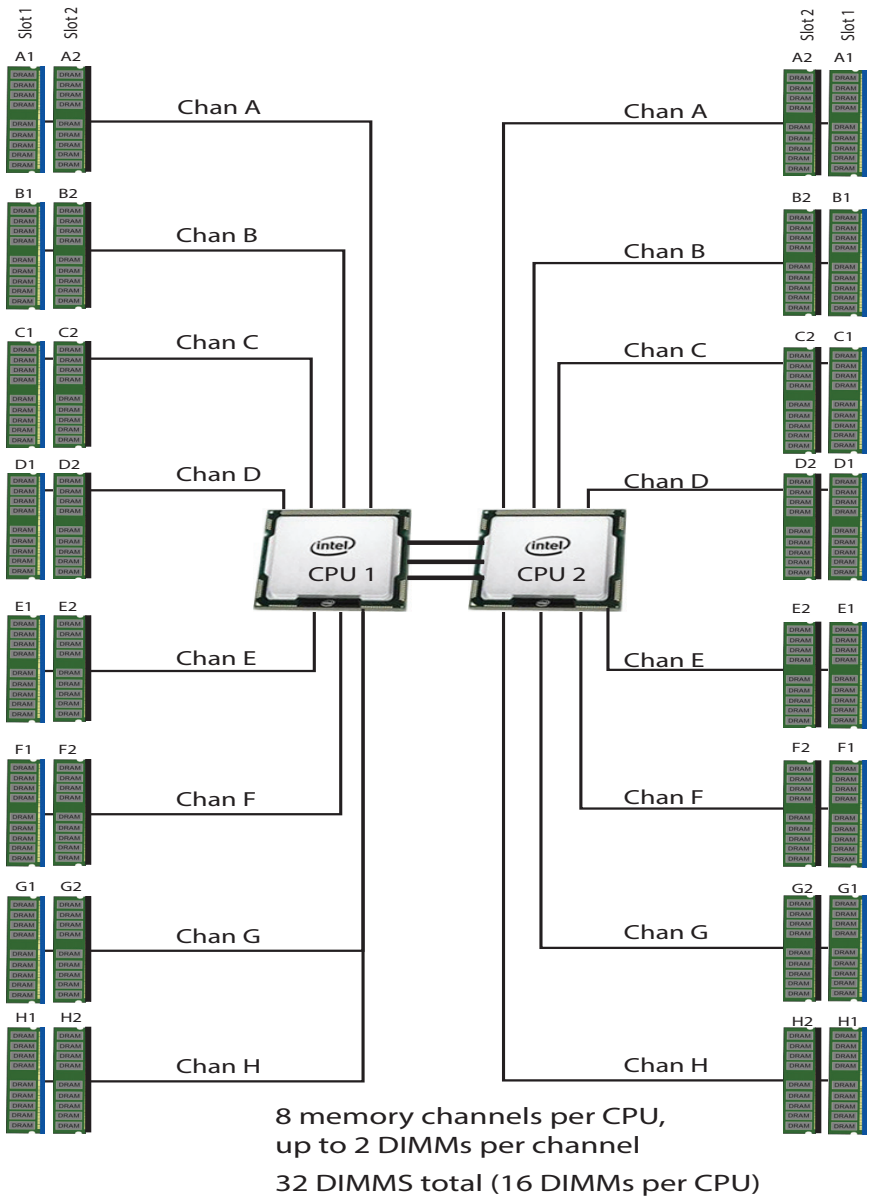

Select DIMMs and Memory Mirroring

Select the memory configuration and whether or not you want the memory mirroring option. The available memory DIMMs and mirroring option are listed in [Table 8](#).



NOTE: When memory mirroring is enabled, the memory subsystem simultaneously writes identical data to two channels. If a memory read from one of the channels returns incorrect data due to an uncorrectable memory error, the system automatically retrieves the data from the other channel. A transient or soft error in one channel does not affect the mirrored data, and operation continues unless there is a simultaneous error in exactly the same location on a DIMM and its mirrored DIMM. Memory mirroring reduces the amount of memory available to the operating system by 50% because only one of the two populated channels provides data.

Table 8 Available DDR5 DIMMs

Product ID (PID)	PID Description
DRAMs	
UCS-MRX16G1RE1	16GB DDR5-4800 RDIMM 1Rx8 (16Gb)
UCS-MRX32G1RE1	32GB DDR5-4800 RDIMM 1Rx4 (16Gb)
UCS-MRX64G2RE1	64GB DDR5-4800 RDIMM 2Rx4 (16Gb)
UCS-MR128G4RE1	128GB DDR5-4800 RDIMM 4Rx4 (16Gb)
Memory Mirroring Option	
N01-MMIRRORD	Memory mirroring option
Accessories/spare included with Memory configuration:	
<ul style="list-style-type: none"> ■ UCS-DDR5-BLK¹ is auto included for the unselected DIMMs slots 	

Notes:

1. Any empty DIMM slot must be populated with a DIMM blank to maintain proper cooling airflow.

Memory configurations and mixing rules

- Memory on every CPU socket shall be configured identically.
- System speed is dependent on the CPU DIMM speed support. Refer to [Available CPUs, page 18](#) for DIMM speeds.
- For full details on supported memory configurations see the [M7 Memory Guide](#).
- DIMM Count Rules:
 - Allowed DIMM count for 1-CPU:
 - Minimum DIMM count = 1; Maximum DIMM count = 16
 - 1, 2, 4, 6, 8, 12¹, or 16 DIMMs allowed
 - 3, 5, 7, 9, 10, 11, 13, 14, 15 DIMMs not allowed.
 - Allowed DIMM count for 2-CPU:
 - Minimum DIMM count = 2; Maximum DIMM count = 32
 - 2, 4, 8, 12, 16, 24¹, or 32 DIMMs allowed
 - 6, 10, 14, 18, 20, 22, 26, 28, 30 DIMMs not allowed.

NOTE(1): 12 DIMMs count for 1-CPU, 24 DIMMs count for 2-CPU configurations are only allowed when all DIMMs have the same density.

- DIMM Population Rules:
 - Each channel has two memory slots (for example, channel A = slots A1 and A2).
 - A channel can operate with one or two DIMMs installed.
 - If a channel has only one DIMM, populate slot 1 first (the blue slot).
 - When both CPUs are installed, populate the memory slots of each CPU identically. Fill the blue slots (slot 1) in the memory channels first according to the recommended DIMM populations in [Table 9](#).

Table 9 M7 DIMM Population Order per socket

#DIMMs per CPU	Population of DIMM slots per socket ¹	
	Slot 1 (Blue)	Slot 2 (Black)
1	A1	-
2	A1, G1	-
4	A1, C1, E1, G1	-
6	A1, C1, D1, E1, F1, G1	-
8	A1, B1, C1, D1, E1, F1, G1, H1	-
12 ²	A1, B1, C1, D1, E1, F1, G1, H1	A2, C2, E2, G2
16	A1, B1, C1, D1, E1, F1, G1, H1	A2, B2, C2, D2, E2, F2, G2, H2

Notes:

1. See [DIMM Mixing Rules](#) for allowed combinations across slots 1 and 2.
2. Only valid when DIMMs in blue and black slots are the same density.

- DIMM Mixing Rules:
 - Higher rank DIMMs shall be populated on Slot 1
 - Mixing different DIMM densities in the same slot across channels is not supported. All populated slots of the same color must have the same DIMM density.
 - The DIMM mixing rules matrix is described in the [Table 10](#), below

Table 10 Supported DIMM mixing and population across 2 slots in each channel

Channel Mixing		DIMM Slot 2 (Black)			
DIMM Slot 1 (Blue)		16GB	32GB	64GB	128GB
		1Rx8	1Rx4	2Rx4	4Rx4
16GB	1Rx8	Yes ¹	No	No	No
32GB	1Rx4	No	Yes ¹	No	No
64GB	2Rx4	No	Yes ²	Yes ¹	No
128GB	4Rx4	No	No	No	Yes ¹

Notes:

1. Only 6 or 8 channels are allowed (for 2, 4, or 8 DIMMs you would just populate 1 DPC on 2, 4, or 8 channels)
2. When mixing two different DIMM densities, all 8 channels per CPU must be populated. Use of fewer than 8 channels (16 slots per CPU) is not supported.

- Memory Limitations:

- Memory on every CPU socket shall be configured identically.
- Refer to [Table 9](#) and [Table 10](#) for DIMM population and DIMM mixing rules.
- Cisco memory from previous generation servers (DDR3 and DDR4) is not supported with the C220 M7 servers.

- For best performance, observe the following:

- For optimum performance, populate at least one DIMM per memory channel per CPU. When one DIMM per channel is used, it must be populated in DIMM slot 1 (blue slot farthest away from the CPU) of a given channel.
- The maximum 2 DPC speed is 4400 MT/s, refer to [Table 11](#) for the details below.

Table 11 DDR5-4800 DIMM 1DPC and 2DPC max speed matrix

CPU max speed/ DIMM max speed	DDR5 DIMM 1DPC	DDR5 DIMM 2DPC
CPU 4000 MT/s	4000 MT/s	4000 MT/s
CPU 4400 MT/s	4400 MT/s	4400 MT/s
CPU 4800 MT/s	4800 MT/s	4400 MT/s



NOTE: For full details on supported memory configurations see the [M7 Memory Guide](#).

STEP 5 SELECT DRIVE CONTROLLERS (OPTIONAL)

The following list summarizes how drives are controlled on the server:

- Servers with SATA drives (only) are controlled by an Intel C621 PCH through the SATA Interposer (AHCI)
- Up to 10 SAS/SATA/NVMe drives are controlled through a Cisco 24G Tri-mode RAID controller¹
- Up to 10 SAS/SATA drives are controlled through a Cisco 12G SAS RAID controller.
- Up to 10 SAS/SATA drives are controlled through a Cisco 12G SAS pass-through HBA.



NOTE: PCIe drives are controlled directly from the CPUs.

RAID Volumes and Groups

When creating each RAID volume, follow these guidelines:

- Use the same capacity for each drive in each RAID volume
- For the Cisco 12G SAS RAID controller, use either all SAS HDDs, or all SAS SSDs, or all SATA SSDs in each RAID volume
- For the Cisco 24G Tri-mode RAID controller, use either all SAS HDDs, or all SAS SSDs, or all SATA SSDs or NVMe SSDs in each RAID volume.



NOTE: 240 virtual drives (VDs) per controller, with up to 64 per disk group with the 12G Raid Controller, and 16 per disk group with the 24G Tri Mode Controller.

Notes . . .

1. Available post first customer ship (FCS).

RAID Controller Options

If you do not want the default AHCI 8 SATA-only drive setup (8 internal drives in drive bays 1-8 and 2 SATA M.2 drives), select one of the following from [Table 12](#).

- One Cisco 24G Tri-mode RAID controller **or**
- One Cisco 12G RAID controller **or**
- One Cisco 12G SAS HBA



NOTE:

- If the Cisco 24G Tri-mode RAID controller, 12G SAS RAID controller or Cisco 12G SAS HBA is selected, it is factory-installed in a dedicated slot.
- The default solution is AHCI, which supports a limited number of drives, operating systems, and virtualized environments. For a more comprehensive solution, choose a controller from [Table 12](#).
- vSAN HCL listed/qualified component is UCSC-SAS-T-D

Table 12 Hardware Controller Options

Product ID (PID)	PID Description
Controllers for Internal Drives	
UCSC-RAID-HP ^{1,2}	Cisco Tri-Mode 24G SAS RAID Controller w/4GB Cache <ul style="list-style-type: none"> ■ This RAID controller supports up to 10 SAS HDDs and SAS/SATA/NVMe SSDs operating at 3Gbps, 6Gbps, 12Gbps and 24Gbps. It includes a SuperCap and a 4GB flash-back write cache (FBWC). ■ Supports RAID0, RAID00, 1, 5, 6, 10, 50, 60, and JBOD mode and supports mixed RAID and JBOD mode. ■ The RAID controller plugs directly into a dedicated slot. ■ For all self-encrypting drives (SED), standalone Management (CIMC/UCSM) is supported for configuring and managing local keys. For now, SED drives are managed with local key management only. Third-party key management will be supported (KMIP compliant).
UCSC-RAID-T-D	Cisco M6 12G SAS RAID Controller with 4GB FBWC (16 Drives) <ul style="list-style-type: none"> ■ This RAID controller supports up to 10 SAS HDDs and SAS/SATA SSD operating at 3Gbps, 6Gbps, and 12Gbps. It includes a SuperCap and a 4GB flash-back write cache (FBWC). ■ Supports RAID0, RAID00, 1, 5, 6, 10, 50, 60, and JBOD mode and supports mixed RAID and JBOD mode. ■ The RAID controller plugs directly into a dedicated slot. ■ For all self-encrypting drives (SED), standalone Management (CIMC/UCSM) is supported for configuring and managing local keys. For now, SED drives are managed with local key management only. Third-party key management will be supported (KMIP compliant).

Table 12 Hardware Controller Options (continued)

Product ID (PID)	PID Description
UCSC-SAS-T-D	<p>Cisco M6 12G SAS HBA for (16 Drives)</p> <ul style="list-style-type: none"> ■ This SAS HBA supports up to 10 SAS HDDs and SAS/SATA SSDs operating at 3Gbps, 6Gbps, and 12Gbps. ■ No RAID support ■ Supports JBOD or pass-through mode ■ The 12G SAS HBA plugs directly into a dedicated slot.
Controller for External Drives	
UCSC-9500-8E-D	<p>Cisco 12G 9500-8e 12G SAS HBA for external JBOD attach</p> <ul style="list-style-type: none"> ■ External Storage HBA plugs in to PCIe slot ■ This controller is half-height half-length and can be installed in riser 1, 2, or 3.
SATA Interposer	
UCSC-SATAIN-220M7	<p>UCS C220 M7 SATA Interposer Board (for control of up to 8 SATA-only drives using AHCI)</p> <ul style="list-style-type: none"> ■ The default configuration is Advanced Host Control Interface (AHCI), which supports SATA-only drives. A maximum of 8 SATA drives are supported with AHCI and this configuration requires a SATA interposer board, which plugs directly into the drive backplane. The SATA Interposer supports drives in slots 1-8. ■ AHCI is limited to Windows and Linux operating systems only. There is no VMware support for AHCI.
<p>Accessories/spare included with drive controller (For UCSC-C220-M7S):</p> <ul style="list-style-type: none"> ■ UCSC-RDBKT-22XM7 is included with the selection of UCSC-SAS-T-D drive controller. ■ CBL-SAS-C220M7, CBL-SCAP-C220-D, UCS-SCAP-D and UCSC-RDBKT-22XM7 are included with the selection of UCSC-RAID-T-D drive controller ■ CBL-SAS-Y-C220M7, CBL-SCAP-C220-D, UCS-SCAP-D and UCSC-HPBKT-22XM7 are included with the selection of UCSC-RAID-HP drive controller. <p>NOTE: If you are adding drive controller later as spare, you may need to order cables/supercap/super cables and controllers bracket with it.</p>	

Notes:

1. Available post first customer ship (FCS).
2. For Tri-Mode 24G SAS RAID Controller (UCSC-RAID-HP) please select one of the two RAID settings:

UCSC-RAID-SASSATA	Controller limited to SAS/SATA RAID
UCSC-RAID-NVMe	Controller limited to NVMe RAID

- If NVMe RAID is selected:
 - Max 10 U.3 NVMe are allowed for NVMe RAID
 - Max 4 U.2 or U.3 NVMe are allowed as passthrough (slots 1-4)
 - No SAS/SATA drives are allowed
- If SAS/SATA RAID is selected:
 - Max 4 U.2 or U.3 NVMe are allowed as passthrough (slots 1-4)
 - Max 10 SAS/SATA drives are allowed

Select one of the RAID Configuration option from the following [Table 13](#).



CAUTION: All RAID options require drives of same sector size and media type. The smallest drive capacity will be used to calculate the RAID volume size.

Table 13 RAID Configuration Options

Product ID (PID)	PID Description
NOTE: Not available for Cisco 12G SAS HBA	
R2XX-SRAID0D	Enable single disk RAID 0 Setting.
R2XX-RAID0D	Factory preconfigured RAID striping option Enable RAID 0 Setting. Requires two or more drive.
R2XX-RAID00D	Factory preconfigured RAID striping option Enable RAID 00 Setting. Requires two or more drive.
R2XX-RAID1D	Factory preconfigured RAID mirroring option Enable RAID 1 Setting. Requires even number of drives (minimum of two).
R2XX-RAID5D	Factory preconfigured RAID option Enable RAID 5 Setting. Requires a minimum of three drives
R2XX-RAID6D	Factory preconfigured RAID option Enable RAID 6 Setting. Requires a minimum of four drives.
R2XX-RAID10D	Factory preconfigured RAID option Enable RAID 10 Setting. Requires even number of drives (minimum of 2 drives per span)
R2XX-RAID50D	Factory preconfigured RAID option Enable RAID 50 Setting. Requires minimum of three drives per span
R2XX-RAID60D	Factory preconfigured RAID option Enable RAID 60 Setting. Requires minimum of four drives per span.

Approved Configurations

Cisco UCS C220 M7 SFF server can be ordered as follows:

- UCSC-C220 M7S (10-drive SAS/SATA/NVMe backplane and optionally 4 of those can be direct-attach NVMe)
- UCSC-C220-M7N (10-drive direct-attach NVMe only)
- There is no RAID support for direct-attach NVMe drives.

STEP 6 SELECT DRIVES (OPTIONAL)

The standard disk drive features are:

- 2.5-inch small form factor
- Hot-pluggable
- Drives come mounted in sleds

Select Drives

- The available NVMe SSDs drives for UCSC-C220-M7N and UCSC-C220-M7S are listed in [Table 14](#)
- The available SAS/SATA SSDs and HDDs drives for UCSC-C220-M7S listed [Table 15](#)



CAUTION: Cisco uses solid state drives (SSDs) from a number of vendors. All solid state drives (SSDs) are subject to physical write limits and have varying maximum usage limitation specifications set by the manufacturer. Cisco will not replace any solid state drives (SSDs) that have exceeded any maximum usage specifications set by Cisco or the manufacturer, as determined solely by Cisco.

Table 14 Available NVMe drives for UCSC-C220-M7N and UCSC-C220-M7S

Product ID (PID)	PID Description	Drive Type	Form Factor	Capacity
PCIe/NVMe SFF (2.5-inch) SFF drives				
UCS-NVMEXP-I400-D	400GB 2.5in U.2 Intel P5800X Optane NVMe Extreme Perform SSD	NVMe	U.2	400 GB
UCS-NVMEXP-I800-D	800GB 2.5in U.2 Intel P5800X Optane NVMe Extreme Perform SSD	NVMe	U.2	800 GB
UCS-NVME4-1600-D	1.6TB 2.5in U.2 P5620 NVMe High Perf High Endurance	NVMe	U.2	1.6 TB
UCS-NVME4-1920-D	1.9TB 2.5in U.2 P5520 NVMe High Perf Medium Endurance	NVMe	U.2	1.9 TB
UCS-NVME4-3200-D	3.2TB 2.5in U.2 P5620 NVMe High Perf High Endurance	NVMe	U.2	3.2 TB
UCS-NVME4-3840-D	3.8TB 2.5in U.2 P5520 NVMe High Perf Medium Endurance	NVMe	U.2	3.8 TB
UCS-NVME4-6400-D	6.4TB 2.5in U.2 P5620 NVMe High Perf High Endurance	NVMe	U.2	6.4 TB
UCS-NVME4-7680-D	7.6TB 2.5in U.2 P5520 NVMe High Perf Medium Endurance	NVMe	U.2	7.6 TB
UCS-NVME4-15360-D	15.3TB 2.5in U.2 P5520 NVMe High Perf Medium Endurance	NVMe	U.2	15.3 TB
UCS-NVMEQ-1536-D	15.3TB 2.5in U.2 P5316 NVMe High Perf Low Endurance	NVMe	U.2	15.3 TB
UCS-NVMEG4-M960-D ¹	960GB 2.5in U.3 Micron P7450 NVMe High Perf Medium Endurance	NVMe	U.3	960 GB
UCS-NVMEG4-M1920D ²	1.9TB 2.5in U.3 Micron P7450 NVMe High Perf Medium Endurance	NVMe	U.3	1.9 TB

Table 14 Available NVMe drives (continued) for UCSC-C220-M7N and UCSC-C220-M7S

Product ID (PID)	PID Description	Drive Type	Form Factor	Capacity
UCS-NVMEG4-M3840D ²	3.8TB 2.5in U.3 Micron P7450 NVMe High Perf Medium Endurance	NVMe	U.3	3.8 TB
UCS-NVMEG4-M7680D ²	7.6TB 2.5in U.3 Micron P7450 NVMe High Perf Medium Endurance	NVMe	U.3	7.6 TB
UCS-NVMEG4-M1536D ²	15.3TB 2.5in U.3 Micron P7450 NVMe High Perf Medium Endurance	NVMe	U.3	15.3 TB
UCS-NVMEG4-M1600D ²	1.6TB 2.5in U.3 Micron P7450 NVMe High Perf High Endurance	NVMe	U.3	1.6 TB
UCS-NVMEG4-M3200D ²	3.2TB 2.5in U.3 Micron P7450 NVMe High Perf High Endurance	NVMe	U.3	3.2 TB
UCS-NVMEG4-M6400D ²	6.4TB 2.5in U.3 Micron P7450 NVMe High Perf High Endurance	NVMe	U.3	6.4 TB
■ CBL-FNVME-C220M7 is auto included with selection of U.3 NVMe drives and Raid controller UCSC-RAID-HP.				

Notes:

1. Only U.3 drives are allowed with RAID 24G Tri-mode RAID Controller and NVMe Hardware RAID.

Table 15 Available SAS/SATA SSD and HDDs for UCSC-C220-M7S

Product ID (PID)	PID Description	Drive Type	Capacity
HDDs			
HDDs (10K RPM)			
UCS-HD600G10KJ4-D	600 GB 12G SAS 10K RPM SFF HDD	SAS	600 GB
UCS-HD12TB10KJ4-D	1.2 TB 12G SAS 10K RPM SFF HDD	SAS	1.2 TB
UCS-HD18TB10KJ4-D	1.8 TB 12G SAS 10K RPM SFF HDD (4K)	SAS	1.8 TB
UCS-HD24TB10KJ4-D	2.4 TB 12G SAS 10K RPM SFF HDD (4K)	SAS	2.4 TB
Enterprise Performance SAS/SATA SSDs (High endurance, supports up to 10X or 3X DWPD (drive writes per day))			
SATA			
UCS-SD480G63XEP-D	480 GB 2.5in Enterprise Performance 6G SATA SSD(3X endurance)	SATA	480 GB
UCS-SD960G63XEP-D	960 GB 2.5in Enterprise performance 6G SATA SSD(3X endurance)	SATA	960 GB
UCS-SD19T63X-EP-D	1.9 TB 2.5in Enterprise performance 6G SATA SSD(3X endurance)	SATA	1.9 TB
UCS-SD38T63X-EP-D	3.8 TB 2.5in Enterprise performance 6G SATA SSD(3X endurance)	SATA	3.8 TB
UCS-SD480GBM3XEPD	480GB SATA SSD 3DWPD	SATA	480 GB
UCS-SD960GBM3XEPD	960GB SATA SSD 3DWPD	SATA	960 GB
UCS-SD19TBM3XEP-D	1.9TB SATA SSD 3DWPD	SATA	1.9 TB
SAS			
UCS-SD800GK3XEP-D	800 GB 2.5in Enterprise Performance 12G SAS SSD(3X endurance)	SAS	800 GB
UCS-SD16TK3X-EP-D	1.6 TB 2.5in Enterprise Performance 12G SAS SSD(3X endurance)	SAS	1.6 TB
UCS-SD32TK3X-EP-D	3.2 TB 2.5in Enterprise Performance 12G SAS SSD(3X endurance)	SAS	3.2 TB
UCS-SD16TKA3XEP-D	1.6TB 2.5in Enterprise Performance 12G SAS SSD(3X endurance)	SAS	1.6 TB
UCS-SD32TKA3XEP-D	3.2TB 2.5in Enterprise Performance 12G SAS SSD(3X endurance)	SAS	3.2 TB

Table 15 Available SAS/SATA SSD and HDDs (continued)for UCSC-C220-M7S

Product ID (PID)	PID Description	Drive Type	Capacity
Enterprise Value SAS/SATA SSDs (Low endurance, supports up to 1X DWPD (drive writes per day))			
SATA			
UCSSD480G6I1XEVD	480GB 2.5 inch Enterprise Value 6G SATA SSD	SATA	480 GB
UCSSD960G6S1XEVD	960GB 2.5 inch Enterprise Value 6G SATA SSD	SATA	960 GB
UCSSD960G6I1XEVD	960GB 2.5 inch Enterprise Value 6G SATA SSD	SATA	960 GB
UCS-SD19T6S1XEVD	1.9TB 2.5 inch Enterprise Value 6G SATA SSD	SATA	1.9 TB
UCS-SD38T6S1XEVD	3.8 TB 2.5 inch Enterprise Value 6G SATA SSD	SATA	3.8 TB
UCS-SD38T6I1XEVD	3.8TB 2.5 inch Enterprise Value 6G SATA SSD	SATA	3.8 TB
UCS-SD76T6S1XEVD	7.6TB 2.5 inch Enterprise Value 6G SATA SSD	SATA	7.6 TB
UCS-SD76TM1X-EVD	7.6TB 2.5 inch Enterprise Value 6G SATA SSD	SATA	7.6 TB
UCS-SD240GBM1XEVD	240GB SATA SSD 1DWPD	SATA	240 GB
UCS-SD480GBM1XEVD	480GB SATA SSD 1DWPD	SATA	480 GB
UCS-SD960GBM1XEVD	960GB SATA SSD 1DWPD	SATA	960 GB
UCS-SD16TBM1XEVD	1.6GB SATA SSD 1DWPD	SATA	1.6 TB
UCS-SD19TBM1XEVD	1.9TB SATA SSD 1DWPD	SATA	1.9 TB
UCS-SD38TBM1XEVD	3.8TB SATA SSD 1DWPD	SATA	3.8 TB
UCS-SD76TBM1XEVD	7.6TB SATA SSD 1DWPD	SATA	7.6 TB
SAS			
UCS-SD960GK1XEVD	960GB 2.5 inch Enterprise Value 12G SAS SSD	SAS	960 GB
UCS-SD19TK1X-EVD	1.9TB 2.5 inch Enterprise Value 12G SAS SSD	SAS	1.9 TB
UCS-SD38TK1X-EVD	3.8TB 2.5 inch Enterprise Value 12G SAS SSD	SAS	3.8 TB
UCS-SD76TK1X-EVD	7.6TB 2.5 inch Enterprise Value 12G SAS SSD	SAS	7.6 TB
UCS-SD15TK1X-EVD	15.3TB 2.5 inch Enterprise Value 12G SAS SSD	SAS	15.3 TB
UCS-SD19TKA1XEVD	1.9TB 2.5 inch Enterprise Value 12G SAS SSD	SAS	1.9 TB
UCS-SD38TKA1XEVD	3.8TB 2.5 inch Enterprise Value 12G SAS SSD	SAS	3.8 TB
UCS-SD76TKA1XEVD	7.6TB 2.5 inch Enterprise Value 12G SAS SSD	SAS	7.6 TB
UCS-SD15TKA1XEVD	15.3TB 2.5 inch Enterprise Value 12G SAS SSD	SAS	15.3 TB
Self-Encrypted Drives (SED) (1X or 3X)			
SATA			
UCSSD38TBEM2NK9-D	3.8TB Enterprise value SATA SSD (1X, SED) Non FIPS	SATA	3.8 TB
SAS			
UCS-SD800GBKNK9-D	800GB Enterprise Performance SAS SSD (3X DWPD, SED) FIPS140-2	SAS	800 GB
UCS-SD960GBKNK9-D	960GB Enterprise Value SAS SSD (1X DWPD, SED) FIPS140-2	SAS	960 GB
UCS-SD16TBKNK9-D	1.6TB Enterprise performance SAS SSD (3X DWPD, SED) FIPS140-2	SAS	1.6 TB
UCS-SD38TBKNK9-D	3.8TB Enterprise Value SAS SSD (1X DWPD, SED) FIPS140-2	SAS	3.8 TB
UCS-SD76TBKNK9-D	7.6TB Enterprise value SAS SSD (1X DWPD, SED-FIPS) FIPS140-2	SAS	7.6 TB
UCS-SD16TBKANK9-D	1.6TB 2.5" Enterprise performance 12GSAS SSD(3DWPD,SED-FIPS) FIPS140-2	SAS	1.6 TB

Table 15 Available SAS/SATA SSD and HDDs (*continued*)for UCSC-C220-M7S

Product ID (PID)	PID Description	Drive Type	Capacity
UCS-SD38TBKANK9-D	3.8TB 2.5" Enterprise value 12G SAS SSD (1DWP, SED-FIPS) FIPS140-2	SAS	3.8 TB
UCS-SD76TBKANK9-D	7.6TB Enterprise value SAS SSD (1DWP, SED-FIPS) FIPS140-2	SAS	7.6 TB
UCS-SD960GM2NK9-D ¹	960GB SED SSD 1DWP	SAS	960 GB
UCS-SD19TEM2NK9-D ¹	1.9TB SED SSD 1DWP	SAS	1.9 TB
UCS-SD38TEM2NK9-D ¹	3.8TB SED SSD 1DWP	SAS	3.8 TB
UCS-SD76TEM2NK9-D ¹	7.6TB SED SSD 1DWP	SAS	7.6 TB
Accessories/spare included with drives (For UCSC-C220-M7S):			
<ul style="list-style-type: none"> ■ CBL-FNVME-C220M7 is auto included with selection of U.3 NVMe drives and Raid controller UCSC-RAID-HP ■ CBL-SATA-C220-D is included with the selection of the SATA drives. ■ UCSC-BBLKD-M7 is included for the not selected front storage device. 			
NOTE: If you are adding drive later as spare, you may need to order cables with it.			

Notes:

1. [Available post first customer ship \(FCS\).](#)

Caveats

- With the UCSC-C220-M7S:
 - You can choose only SATA HDDs when using AHCI with a SATA Interposer. The drives must be installed in slots 1-8.
 - Unless RAID 24G Tri-mode RAID Controller and NVMe Hardware RAID are selected, SFF NVMe drives are connected directly to CPU2 and not managed by any drive controller.
 - If you order any direct-attach NVMe SFF drives, you must also order two CPUs.
 - You can mix HDDs and SSDs as long as you keep all HDDs in their own RAID volume and all SSDs in their own RAID volume.
 - SED drives can be mixed with the non-SED drives in [Table 15 on page 32](#).
- SFF NVMe drives are bootable in UEFI mode only.
- U.3 drives are allowed with RAID 24G Tri-mode RAID Controller and NVMe Hardware RAID.

STEP 7 SELECT OPTION CARD(S) (OPTIONAL)

For up-to-date server compatibility, please check the Hardware and Software compatibility list (HCL) at <https://ucshcltool.cloudapps.cisco.com/public/>.

The standard PCIe card offerings are:

- Modular LAN on Motherboard (mLOM)
- Open Compute Project (OCP) 3.0
- Virtual Interface Cards (VICs)
- Network Interface Cards (NICs)
- Host Bus Adapters (HBAs)

Select Option Cards

The available option cards are listed in [Table 16](#)

Table 16 Available PCIe Option Cards

Product ID (PID)	PID Description	Location	Card Size ¹
Modular LAN on Motherboard (mLOM)			
UCSC-M-V5Q50G-D	Cisco VIC 15428 4x 10/25/50G mLOM C-Series	mLOM	HHHL, SS
UCSC-M-V5D200G-D	Cisco VIC 15238 2x 40/100/200G mLOM C-Series	mLOM	HHHL, SS
UCSC-M-V5Q50GV2-D	Cisco VIC 15427 4x 10/25/50G mLOM C-Series w/Secure Boot	mLOM	HHHL, SS
UCSC-M-V5D200GV2D	Cisco VIC 15237 2x 40/100/200G mLOM C-Series w/Secure Boot	mLOM	HHHL, SS
Open Compute Project (OCP)			
UCSC-O-ID10GC-D ²	Intel X710T2LOCPV3G1L 2x10GbE RJ45 OCP 3.0 NIC	OCP	SFF
Virtual Interface Cards (VICs)			
UCSC-P-V5Q50G-D	Cisco VIC 15425 4x 10/25/50G PCIe C-Series w/Secure Boot	Riser 1 or 3	HHHL, SS
UCSC-P-V5D200G-D	Cisco VIC 15235 2x 40/100/200G PCIe C-Series w/Secure Boot	Riser 1 or 3	HHHL, SS
Network Interface Cards (NICs)			
1GB NICs			
UCSC-P-IQ1GC	Cisco-Intel I710-T4L 4x1GBASE-T NIC	Riser 1, 2, or 3	HHHL, SS
10GB NICs			
UCSC-PCIEID10GF-D	Intel X710-DA2 Dual Port 10Gb SFP+ NIC	Riser 1, 2, or 3	HHHL, SS
UCSC-PCIEIQ10GF-D	Intel X710 quad-port 10G SFP+ NIC	Riser 1, 2, or 3	HHHL, SS
UCSC-P-ID10GC-D	Cisco-Intel X710T2LG 2x10GBE RJ45 PCIe NIC	Riser 1, 2, or 3	HHHL, SS
UCSC-P-IQ10GC-D	Cisco-Intel X710T4LG 4x10GBE RJ45 PCIe NIC	Riser 1, 2, or 3	HHHL, SS
25GB NICs			
UCSC-P-I8D25GF-D ³	Cisco-Intel E810XXVDA2 2x25/10GBE SFP28 PCIe NIC	Riser 1, 2, or 3	HHHL, SS
UCSC-P-I8Q25GF-D ³	Cisco-Intel E810XXVDA4L 4x25/10GBE SFP28 PCIe NIC	Riser 1C or 3C	FHHL, SS

Table 16 Available PCIe Option Cards (*continued*)

Product ID (PID)	PID Description	Location	Card Size ¹
100GB NICs			
UCSC-P-MCD100GF-D ^{3,4}	Cisco-MLNX MCX623106AC-CDAT 2x100GbE QSFP56 PCIe NIC (with Crypto)	Riser 1, 2, or 3	HHHL, SS
UCSC-P-MDD100GF-D ^{3,4}	Cisco-MLNX MCX623106AS-CDAT 2x100GbE QSFP56 PCIe NIC	Riser 1, 2, or 3	HHHL, SS
UCSC-P-I8D100GF-D ^{3,4}	Cisco-Intel E810CQDA2 2x100 GbE QSFP28 PCIe NIC	Riser 1, 2, or 3	HHHL, SS
Host Bus Adapters (HBAs)			
UCSC-P-Q6D32GF-D	Cisco-QLogic QLE2772 2x32GFC Gen 6 Enhanced PCIe HBA	Riser 1, 2, or 3	HHHL, SS
UCSC-P-B7D32GF-D	Cisco-Emulex LPe35002-M2-2x32GFC Gen 7 PCIe HBA	Riser 1, 2, or 3	HHHL, SS
UCSC-PCIEQD16GF-D	Qlogic QLE2692 dual-port 16G FC HBA	Riser 1, 2, or 3	HHHL, SS
UCSC-PCIEBD16GF-D	Emulex LPe31002 dual port 16G FC HBA	Riser 1, 2, or 3	HHHL, SS
UCSC-P-Q7D64GF	Cisco-QLogic QLE2872, 2x64GFC Gen 7 PCIe HBA	Riser 1, 2, or 3	HHHL, SS
External Storage HBA			
UCSC-9500-8E-D	Cisco 12G 9500-8e 12G SAS HBA for external JBOD attach	Riser 1, 2, or 3	HHHL, SS
Accessories/spare included with PCI Card.			
<ul style="list-style-type: none"> ■ UCSC-OCP3-KIT-D is included along with the selection UCSC-O-ID10GC-D card 			

Notes:

1. HHHL = half-height, half-length; FHHL = full-height, half-length; SS = single-slot; DS = double-slot. SFF = small form factor.
2. For installation in the mLOM slot, you can order either an mLOM VIC, or the OCP NIC - but not both. If ordering the OCP NIC, the OCP Mechanical Kit (UCSC-OCP3-KIT) must also be installed in order to mount OCP NIC in the mLOM slot.
3. When present, the recommended Fan Speed Control policy setting is balanced.
4. NICs with 16 active electrical lanes, such as the 100G NICs, can be inserted in slots with 8 active electrical lanes. The NIC will function but may exhibit degraded performance.

Approved Configurations**(1) 1-CPU Systems**

- You can select up to two of the PCIe option cards listed in [Table 16](#) to be installed in Riser 1 and Riser 2. Riser 1 and Riser 2 is controlled by CPU 1. Risers 3 cannot installed in a 1-CPU system.

(2) 2-CPU Systems

- You can select up to two of the PCIe option cards listed in [Table 16](#) for a two-riser system and up to three of the PCIe option cards for a three-riser system. Risers 1 and 2 are controlled by CPU 1 and riser 3 is controlled by CPU 2.

Caveats

- For 1-CPU systems:
 - Half Height Riser 1 and Riser 2 is supported. Full Height Riser 1 is supported
 - Only a single plug-in PCIe VIC card is supported and must be installed in Riser 1. However, in addition to the one PCIe VIC card, you can also choose to install an mLOM/OCP 3.0 card in the mLOM slot at the rear of the chassis.
- For 2-CPU systems:
 - All risers (Risers 1, 2, and 3) are supported
 - Two plug-in PCIe VIC cards can be installed in 2-CPU systems. VICs can be placed in Riser 1 or 3 only for 1U in half height riser combination. For full height riser, you can use either Riser 1 or 2 for the VICs. In addition, you can order an mLOM/OCP 3.0 card, which is installed in the mLOM/OCP 3.0 slot at the rear of the chassis and thus have three VIC cards in operation at the same time. See [Table 16 on page 35](#) for the selection of plug-in and mLOM VIC cards. See also [Figure 7 on page 56](#) for the mLOM VIC card slot.
- To help ensure that your operating system is compatible with the card you have selected, or to see additional cards that have been qualified to work with the UCS C220 M7 server, but are not sold on the Cisco pricelist, check the Hardware Compatibility List at this URL:
http://www.cisco.com/en/US/products/ps10477/prod_technical_reference_list.html
- For installation in the mLOM slot, you can order either an mLOM VIC, or the OCP NIC - but not both. If ordering the OCP NIC, the OCP Mechanical Kit (UCSC-OCP3-KIT) must also be installed in order to mount OCP NIC in the mLOM slot.

ORDER OPTIONAL PCIe OPTION CARD ACCESSORIES

- At the time of first launch, the 3rd Party Ethernet adapters were tested for interoperability with an initial selection of Optical Modules and Cables. Please check the Product Briefs for this initial list of interoperable optics and cables at <https://www.cisco.com/c/en/us/products/servers-unified-computing/third-party-adapters-listing.html>.
- For list of supported optics and cables for VIC 15428 and VIC 15238, refer to the VIC 15000 series data sheet at <https://www.cisco.com/c/en/us/products/collateral/interfaces-modules/unified-computing-system-adapters/ucs-vic-15000-series-ds.htm>
- Cisco Transceiver Module Group (TMG) conducts tests with Cisco optics and cables and publishes the results in the TMG Compatibility Matrix. The latest compatibility with optical modules and DACs can be found at <https://tmgmatrix.cisco.com/>
- Refer to the these links for additional connectivity options.

Intel:
Product Guide
Speed White Paper

STEP 8 ORDER GPU CARDS (OPTIONAL)**CAUTION:**

- Gen4 and Gen5 risers cannot be mixed, for example: If UCSC-RIS2A-C22XM7 (GEN4) is selected, cannot select UCSC-RIS2B-C22XM7 (GEN5)

Select GPU Options

The available GPU PCIe options are listed in [Table 17](#).

Table 17 Available PCIe GPU Cards¹

Product ID (PID)	PID Description	Card Size	Maximum cards Per node	Riser Compatibility
UCSC-GPU-L4	NVIDIA L4:70W, 24GB, 1-slot HHHL GPU	HHHL, single-wide	3	Gen 4 & Gen 5 Half Height and Full Hight Riser
UCSC-GPU-FLEX140	Intel GPU Flex 140, Gen4x8, HHHL, 75W PCIe	HHHL, single-wide	3	Gen 5 Half Height Risers

Notes:

1. Refer to [C220 M7 installation guide](#) for more details.

**NOTE:**

- All GPU cards must be procured from Cisco as there is a unique SBIOS ID required by CIMC and UCSM
- GPUs cannot be mixed.

STEP 9 ORDER POWER SUPPLY (REQUIRED)

Power supplies share a common electrical and physical design that allows for hot-plug and tool-less installation into M7 C-series servers. Each power supply is certified for high-efficiency operation and offers multiple power output options. This allows users to “right-size” based on server configuration, which improves power efficiency, lowers overall energy costs and avoids stranded capacity in the data center.

Use the power calculator at the following link to determine the needed power based on the options chosen (CPUs, drives, memory, and so on):

<http://ucspowercalc.cisco.com>

Table 18 Power Supply

Product ID (PID)	PID Description
PSU (Input High Line 210VAC)	
UCSC-PSU1-770W-D	Cisco UCS 770W AC Power Supply for Rack Server Platinum
UCSC-PSUV21050D-D	Cisco UCS 1050W -48V DC Power Supply for Rack Server Platinum
UCSC-PSU1-1200W-D	1200W Titanium power supply for C-Series Servers Titanium
UCSC-PSU1-1600W-D	1600W AC power supply for C-Series servers Platinum
UCSC-PSU1-2300W-D	2300W Power supply for C-series servers Titanium
PSU (Input Low Line 110VAC)	
UCSC-PSU1-770W-D	Cisco UCS 770W AC Power Supply for Rack Server Platinum
UCSC-PSU1-1200W-D	1200W Titanium power supply for C-Series Servers Titanium
UCSC-PSU1-2300W-D	2300W Power supply for C-series servers Titanium



NOTE:

- In a server with two power supplies, both power supplies must be identical.
- Refer to [Power Specifications, page 76](#) section for the full details on the each power supply.

STEP 10 SELECT INPUT POWER CORD(S) (REQUIRED)

Using [Table 19](#) and [Table 20](#), select the appropriate AC power cords. You can select a minimum of no power cords and a maximum of two. If you select the option R2XX-DMYPWRCORD, no power cord is shipped with the server.



NOTE: [Table 19](#) lists the power cords for servers that use power supplies less than 2300 W. [Table 20](#) lists the power cords for servers that use 2300 W power supplies. Note that the power cords for 2300 W power supplies use a C19 connector so they only fit the 2300 W power supply connector.

Table 19 Available Power Cords (for server PSUs less than 2300 W)

Product ID (PID)	PID Description	Images
NO-POWER-CORD	ECO friendly green option, no power cable will be shipped	
CAB-48DC40A8AWG-D	C-Series -48VDC PSU Power Cord, 3.5M, 3 Wire, 8AWG, 40A	
CAB-N5K6A-NA	Power Cord, 200/240V 6A, North America	
CAB-AC-L620-C13-D	AC Power Cord, NEMA L6-20 - C13, 2M/6.5ft	
CAB-C13-CBN	CABASY,WIRE,JUMPER CORD, 27" L, C13/C14, 10A/250V	
CAB-C13-C14-2M	CABASY,WIRE,JUMPER CORD, PWR, 2 Meter, C13/C14,10A/250V	

Table 19 Available Power Cords (for server PSUs less than 2300 W)

Product ID (PID)	PID Description	Images
CAB-C13-C14-AC	CORD,PWR,JMP,IEC60320/C14,IEC60320/C13, 3.0M	
CAB-250V-10A-AR	Power Cord, 250V, 10A, Argentina	
CAB-9K10A-AU	Power Cord, 250VAC 10A 3112 Plug, Australia	
CAB-250V-10A-CN	AC Power Cord - 250V, 10A - PRC	
CAB-9K10A-EU	Power Cord, 250VAC 10A CEE 7/7 Plug, EU	
CAB-250V-10A-ID	Power Cord, 250V, 10A, India	
CAB-C13-C14-3M-IN	Power Cord Jumper, C13-C14 Connectors, 3 Meter Length, India	Image not available
CAB-C13-C14-IN	Power Cord Jumper,C13-C14 Connectors,1.4 Meter Length, India	Image not available
CAB-250V-10A-IS	Power Cord, SFS, 250V, 10A, Israel	

Table 19 Available Power Cords (for server PSUs less than 2300 W)

Product ID (PID)	PID Description	Images
CAB-9K10A-IT	Power Cord, 250VAC 10A CEI 23-16/VII Plug, Italy	
CAB-9K10A-SW	Power Cord, 250VAC 10A MP232 Plug, Switzerland	
CAB-9K10A-UK	Power Cord, 250VAC 10A BS1363 Plug (13 A fuse), UK	
CAB-9K12A-NA ¹	Power Cord, 125VAC 13A NEMA 5-15 Plug, North America	
CAB-250V-10A-BR	Power Cord - 250V, 10A - Brazil	
CAB-C13C142M-JP-D	Power Cord C13-C14, 2M/6.5ft Japan PSE mark	Image not available
CAB-9K10A-KOR ¹	Power Cord, 125VAC 13A KSC8305 Plug, Korea	Image not available
CAB-ACTW	AC Power Cord (Taiwan), C13, EL 302, 2.3M	Image not available
CAB-JPN-3PIN	Japan, 90-125VAC 12A NEMA 5-15 Plug, 2.4m	Image not available
CAB-48DC40A-INT-D	C-Series -48VDC PSU PWR Cord, 3.5M, 3 Wire, 8AWG, 40A (INT)	Image not available
CAB-48DC-40A-AS-D	C-Series -48VDC PSU PWR Cord, 3.5M, 3Wire, 8AWG, 40A (AS/NZ)	Image not available

Notes:

1. This power cord is rated to 125V and only supported for PSU rated at 1050W or less

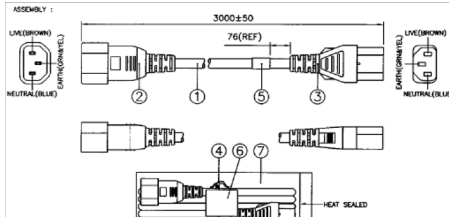
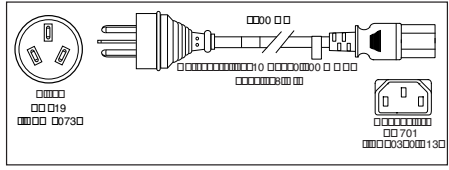
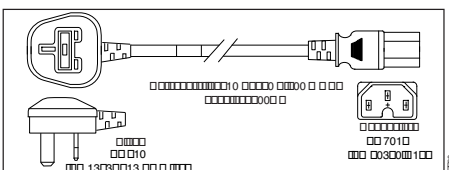
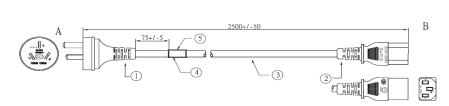
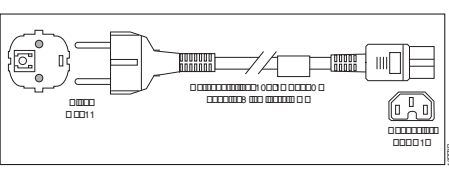
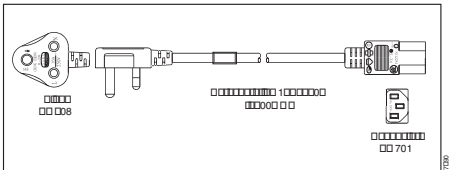
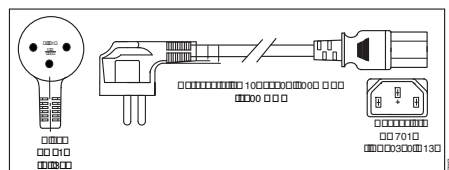
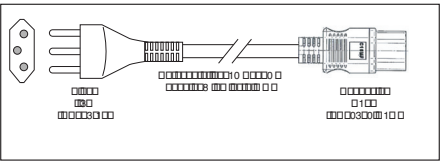
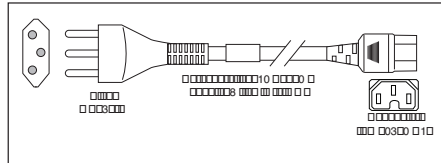
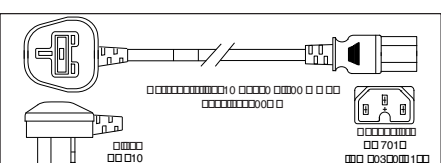
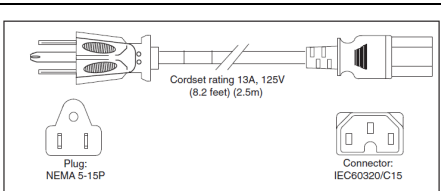
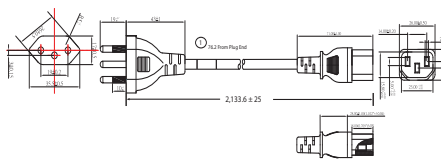
Table 20 Available Power Cords (for servers with 2300 W PSUs)

Product ID (PID)	PID Description	Images
CAB-C19-CBN	Cabinet Jumper Power Cord, 250 VAC 16A, C20-C19 Connectors	Not applicable
CAB-S132-C19-ISRL	S132 to IEC-C19 14ft Israeli	Image not available
CAB-IR2073-C19-AR	IRSM 2073 to IEC-C19 14ft Argen	Image not available
CAB-BS1363-C19-UK	BS-1363 to IEC-C19 14ft UK	Image not available
CAB-SABS-C19-IND	SABS 164-1 to IEC-C19 India	Image not available
CAB-C2316-C19-IT	CEI 23-16 to IEC-C19 14ft Italy	Image not available
CAB-L520P-C19-US	NEMA L5-20 to IEC-C19 6ft US	Image not available
CAB-US515P-C19-US	NEMA 5-15 to IEC-C19 13ft US	Image not available
CAB-US520-C19-US	NEMA 5-20 to IEC-C19 14ft US	Image not available
CAB-US620P-C19-US	NEMA 6-20 to IEC-C19 13ft US	Image not available

STEP 11 ORDER TOOL-LESS RAIL KIT (REQUIRED) AND REVERSIBLE CABLE MANAGEMENT ARM (OPTIONAL)

■ Tool-less Rail Kit:

Select a tool-less rail kit (or no rail kit) from [Table 21](#).



NOTE:

- Cisco recommends a minimum quantity of 1 Rail Kit
- If you plan to rackmount your UCS C220 M7 server, you must order a tool-less rail kit.

Table 21 Tool-less Rail Kit Options

Product ID (PID)	PID Description
UCSC-RAIL-D	Ball Bearing Rail Kit for C220 & C240 M6/M7 rack servers
UCSC-RAIL-NONE-D	No rail kit option

■ Optional Reversible Cable Management Arm:

The reversible cable management arm mounts on either the right or left slide rails at the rear of the server and is used for cable management. Select an Optional Reversible Cable Management Arm from [Table 22](#).



NOTE: If you plan to rackmount your UCS C220 M7 server, you must order a tool-less rail kit. The same rail kits and CMAs are used for M6 and M7 servers.

Table 22 Cable Management Arm

Product ID (PID)	PID Description
UCSC-CMA-C220-D	Reversible CMA for C220 M6/M7 ball bearing rail kit

For more information about the tool-less rail kit and cable management arm, check the [Cisco UCS C220 M7 Installation Guide](#).

STEP 12 SELECT MANAGEMENT CONFIGURATION (OPTIONAL)

By default, the C220 M7 server NIC mode is configured to be Shared LOM Extended. This NIC mode allows any LOM port or adapter card port to be used to access the Cisco Integrated Management Controller (CIMC). The Cisco VIC card must be installed in a slot with NCSI support.



NOTE:

- There are no LOM ports on the C220 and C240 M7 servers. Servers ordered without a VIC or OCP card will ship in Dedicated network mode, unless otherwise specified by a configurable SW PID (**UCSC-CCARD-01**)
- For full details on all the NIC mode settings, see

https://www.cisco.com/c/en/us/td/docs/unified_computing/ucs/c/hw/c220m6/install/c220m7/m_maintaining_the_server.html?bookSearch=true

Table 23 Management Configuration Ordering Information

Product ID (PID)	PID Description
UCSC-DLOM-01-D	Dedicated Mode BIOS setting for C-Series Servers <ul style="list-style-type: none"> ■ To change the default NIC mode to Dedicated NIC mode, select this card. ■ In Dedicated NIC mode, the CIMC can be accessed only through the dedicated management port. ■ See <i>Chassis Rear View (two full-height, 3/4-length PCIe risers)</i>, page 8 for the location of the management port
UCSC-CCARD-01-D	Cisco Card Mode BIOS setting for C-Series Servers <ul style="list-style-type: none"> ■ To change the default NIC mode to Cisco Card Mode, select this card. ■ If Cisco card selected, a VIC or MLOM must also be included in the configuration. if OCP card is included in the configuration, a VIC card must be selected. ■ In this mode, you can assign an IP address to the CIMC using DHCP and from there you can fully automate your deployment.

In addition, the optional software PIDs listed in [Table 30 on page 50](#) can be ordered for setting the server to operate in various modes.

STEP 13 ORDER SECURITY DEVICES (REQUIRED)

A Trusted Platform Module (TPM) is a computer chip (microcontroller) that can securely store artifacts used to authenticate the platform (server). These artifacts can include passwords, certificates, or encryption keys. A TPM can also be used to store platform measurements that help ensure that the platform remains trustworthy. Authentication (ensuring that the platform can prove that it is what it claims to be) and attestation (a process helping to prove that a platform is trustworthy and has not been breached) are necessary steps to ensure safer computing in all environments.

A chassis intrusion switch gives a notification of any unauthorized mechanical access into the server.

The security device ordering information is listed in [Table 24](#)



NOTE:

- The TPM module used in this system conforms to TPM v1.2 and 2.0, as defined by the Trusted Computing Group (TCG). It is also SPI-based.
- TPM installation is supported after-factory. However, a TPM installs with a one-way screw and cannot be replaced, upgraded, or moved to another server. If a server with a TPM is returned, the replacement server must be ordered with a new TPM.

Table 24 Security Devices

Product ID (PID)	PID Description
UCSX-TPM-002C-D	Trusted Platform Module 2.0 for UCS servers
UCSC-INT-SW02-D	C220 and C240 M7 Chassis Intrusion Switch
UCSX-TPM-OPT-OUT-D	OPT OUT, TPM 2.0, TCG, FIPS140-2, CC EAL4+ Certified ¹

Notes:

1. Please note that Microsoft certification requires a TPM 2.0 for bare-metal or guest VM deployments. Opt-out of the TPM 2.0 voids the Microsoft certification

STEP 14 SELECT LOCKING SECURITY BEZEL (OPTIONAL)

An optional locking bezel can be mounted to the front of the chassis to prevent unauthorized access to the drives.

Select the locking bezel from [Table 25](#).

Table 25 Locking Bezel Option

Product ID (PID)	Description
UCSC-BZL-C220-D	C220 M7 Security Bezel

STEP 15 ORDER M.2 SATA SSDs (OPTIONAL)

- Order one or two matching M.2 SATA SSDs from [Table 26](#) along with a boot-optimized RAID controller (see [Table 27](#)). See [Figure 7 on page 56](#) for the location of the module connector on the motherboard. This connector accepts the boot-optimized RAID controller. Each boot-optimized RAID controller can accommodate up to two SATA M.2 SSDs.



NOTE:

- It is recommended that M.2 SATA SSDs be used as boot-only devices.
- Order one or two identical M.2 SATA SSDs for the boot optimized RAID controller
- You cannot mix M.2 SATA SSD capacities.

Table 26 M.2 SATA SSDs

Product ID (PID)	PID Description
UCS-M2-240GB-D	240GB M.2 SATA SSD
UCS-M2-960GB-D	960GB M.2 SATA SSD
UCS-M2-I240GB-D	240GB SATA M.2 SSD
UCS-M2-I480GB-D	480GB SATA M.2 SSD
UCS-M2-240G-D	240GB M.2 SATA Micron G2 SSD
UCS-M2-960G-D	960GB M.2 SATA Micron G2 SSD

- Order Cisco boot optimized M.2 RAID controller from [Table 27](#). The boot optimized RAID controller plugs into a connector on the motherboard and holds up to two M.2 SATA drives.



NOTE:

- The Cisco boot optimized M.2 RAID controller supports VMWare, Windows and Linux Operating Systems
- The Cisco boot optimized M.2 RAID controller supports RAID 1 and JBOD mode
- The Cisco boot optimized M.2 RAID controller is available only with 240GB, 480GB, and 960GB M.2 SSDs.
- CIMC is supported for configuring of volumes and monitoring of the controller and installed SATA M.2 drives
- The SATA M.2 drives can boot in UEFI mode only. Legacy boot mode is not supported
- Hot-plugin replacement is not supported. The server must be powered off.

Table 27 Boot-Optimized RAID Controller

Product ID (PID)	PID Description
UCS-M2-HWRAID-D	Cisco Boot optimized M.2 RAID controller (holds up to two M.2 SATA SSDs)

STEP 16 ORDER M.2 NVMe AND RAID CONTROLLER(OPTIONAL)

- Order one or two matching M.2 NVMe from [Table 28](#) along with a boot-optimized RAID controller (see [Table 29](#)). See [Figure 7 on page 56](#) for the location of the module connector on the motherboard. This connector accepts the boot-optimized RAID controller. Each boot-optimized RAID controller can accommodate up to two SATA M.2 NVMe



NOTE:

- It is recommended that M.2 NVMe be used as boot-only devices.
- Order one or two identical M.2 NVMe for the boot optimized RAID controller
- You cannot mix M.2 NVMe capacities.

Table 28 M.2 NVMe

Product ID (PID)	PID Description
UCS-NVM2-400GB	400GB M.2 Boot NVMe
UCS-NVM2-960GB	960GB M.2 Boot NVMe

- Order Cisco boot optimized M.2 NVMe RAID controller from [Table 29](#). The boot optimized RAID controller plugs into a connector on the motherboard and holds up to two M.2 NVMe drives.

Table 29 Boot-Optimized RAID Controller

Product ID (PID)	PID Description
UCS-M2-NVRAID	Cisco M.2 NVMe BOOT RAID Controller (HHHL)

STEP 17 SELECT OPERATING SYSTEM AND VALUE-ADDED SOFTWARE

Select

- Cisco Software ([Table 30](#))
- Operating System ([Table 31](#))



NOTE: See this link for operating system guidance:
<https://ucshcltool.cloudapps.cisco.com/public/>

Table 30 OEM Software

Product ID (PID)	PID Description
VMware vCenter	
VMW-VCS-STD-D1A	VMware vCenter 7 Server Standard, 1 yr support required
VMW-VCS-STD-D3A	VMware vCenter 7 Server Standard, 3 yr support required
VMW-VCS-STD-D5A	VMware vCenter 7 Server Standard, 5 yr support required
VMW-VCS-FND-D1A	VMware vCenter Server 7 Foundation (4 Host), 1 yr supp reqd
VMW-VCS-FND-D3A	VMware vCenter Server 7 Foundation (4 Host), 3 yr supp reqd
VMW-VCS-FND-D5A	VMware vCenter Server 7 Foundation (4 Host), 5 yr supp reqd

Table 31 Operating System

Product ID (PID)	PID Description
Microsoft Windows Server	
MSWS-22-ST16CD	Windows Server 2022 Standard (16 Cores/2 VMs)
MSWS-22-ST16CD-NS	Windows Server 2022 Standard (16 Cores/2 VMs) - No Cisco SVC
MSWS-22-DC16CD	Windows Server 2022 Data Center (16 Cores/Unlimited VMs)
MSWS-22-DC16CD-NS	Windows Server 2022 DC (16 Cores/Unlim VMs) - No Cisco SVC
MSWS-19-ST16CD	Windows Server 2019 Standard (16 Cores/2 VMs)
MSWS-19-ST16CD-NS	Windows Server 2019 Standard (16 Cores/2 VMs) - No Cisco SVC
MSWS-19-DC16CD	Windows Server 2019 Data Center (16 Cores/Unlimited VMs)
MSWS-19-DC16CD-NS	Windows Server 2019 DC (16 Cores/Unlim VMs) - No Cisco SVC
Red Hat	
RHEL-2S2V-D1A	Red Hat Enterprise Linux (1-2 CPU,1-2 VN); 1-Yr Support Req

Table 31 Operating System (continued)

Product ID (PID)	PID Description
RHEL-2S2V-D3A	Red Hat Enterprise Linux (1-2 CPU,1-2 VN); 3-Yr Support Req
RHEL-2S2V-D5A	Red Hat Enterprise Linux (1-2 CPU,1-2 VN); 5-Yr Support Req
RHEL-VDC-2SUV-D1A	RHEL for Virt Datacenters (1-2 CPU, Unlim VN) 1 Yr Supp Req
RHEL-VDC-2SUV-D3A	RHEL for Virt Datacenters (1-2 CPU, Unlim VN) 3 Yr Supp Req
RHEL-VDC-2SUV-D5A	RHEL for Virt Datacenters (1-2 CPU, Unlim VN) 5 Yr Supp Req
Red Hat Ent Linux/ High Avail/ Res Strg/ Scal	
RHEL-2S2V-D1S	Red Hat Enterprise Linux (1-2 CPU,1-2 VN); Prem 1Yr SnS Reqd
RHEL-2S2V-D3S	Red Hat Enterprise Linux (1-2 CPU,1-2 VN); Prem 3Yr SnS Reqd
RHEL-2S-HA-D1S	RHEL High Availability (1-2 CPU); Premium 1-yr SnS Reqd
RHEL-2S-HA-D3S	RHEL High Availability (1-2 CPU); Premium 3-yr SnS Reqd
RHEL-2S-RS-D1S	RHEL Resilent Storage (1-2 CPU); Premium 1-yr SnS Reqd
RHEL-2S-RS-D3S	RHEL Resilent Storage (1-2 CPU); Premium 3-yr SnS Reqd
RHEL-VDC-2SUV-D1S	RHEL for Virt Datacenters (1-2 CPU, Unlim VN) 1 Yr SnS Reqd
RHEL-VDC-2SUV-D3S	RHEL for Virt Datacenters (1-2 CPU, Unlim VN) 3 Yr SnS Reqd
Red Hat SAP	
RHEL-SAP-2S2V-D1S	RHEL for SAP Apps (1-2 CPU, 1-2 VN); Prem 1-Yr SnS Reqd
RHEL-SAP-2S2V-D3S	RHEL for SAP Apps (1-2 CPU, 1-2 VN); Prem 3-Yr SnS Reqd
RHEL-SAPSP-D3S	RHEL SAP Solutions Premium - 3 Years
RHEL-SAPSS-D3S	RHEL SAP Solutions Standard - 3 Years
VMware	
VMW-VSP-STD-D1A	VMware vSphere 7 Std (1 CPU, 32 Core) 1-yr, Support Required
VMW-VSP-STD-D3A	VMware vSphere 7 Std (1 CPU, 32 Core) 3-yr, Support Required
VMW-VSP-STD-D5A	VMware vSphere 7 Std (1 CPU, 32 Core) 5-yr, Support Required
VMW-VSP-EPL-D1A	VMware vSphere 7 Ent Plus (1 CPU, 32 Core) 1Yr, Support Reqd
VMW-VSP-EPL-D3A	VMware vSphere 7 Ent Plus (1 CPU, 32 Core) 3Yr, Support Reqd
VMW-VSP-EPL-D5A	VMware vSphere 7 Ent Plus (1 CPU, 32 Core) 5Yr, Support Reqd
SUSE	
SLES-2S2V-D1A	SUSE Linux Enterprise Svr (1-2 CPU,1-2 VM); 1-Yr Support Req
SLES-2S2V-D3A	SUSE Linux Enterprise Svr (1-2 CPU,1-2 VM); 3-Yr Support Req

Table 31 Operating System (*continued*)

Product ID (PID)	PID Description
SLES-2S2V-D5A	SUSE Linux Enterprise Svr (1-2 CPU,1-2 VM); 5-Yr Support Req
SLES-2SUVM-D1A	SUSE Linux Enterprise Svr (1-2 CPU,Unl VM) LP; 1Y Supp Req
SLES-2SUVM-D3A	SUSE Linux Enterprise Svr (1-2 CPU,Unl VM) LP; 3Y Supp Req
SLES-2SUVM-D5A	SUSE Linux Enterprise Svr (1-2 CPU,Unl VM) LP; 5Y Supp Req
SLES-2S-LP-D1A	SUSE Linux Live Patching Add-on (1-2 CPU); 1yr Support Req
SLES-2S-LP-D3A	SUSE Linux Live Patching Add-on (1-2 CPU); 3yr Support Req
SLES-2S2V-D1S	SUSE Linux Enterprise Svr (1-2 CPU,1-2 VM); Prio 1-Yr SnS
SLES-2S2V-D3S	SUSE Linux Enterprise Svr (1-2 CPU,1-2 VM); Prio 3-Yr SnS
SLES-2S2V-D5S	SUSE Linux Enterprise Svr (1-2 CPU,1-2 VM); Prio 5-Yr SnS
SLES-2SUVM-D1S	SUSE Linux Enterprise Svr (1-2 CPU,Unl VM) LP; Prio 1Y SnS
SLES-2SUVM-D3S	SUSE Linux Enterprise Svr (1-2 CPU,Unl VM) LP; Prio 3Y SnS
SLES-2SUVM-D5S	SUSE Linux Enterprise Svr (1-2 CPU,Unl VM) LP; Prio 5Y SnS
SLES-2S-HA-D1S	SUSE Linux High Availability Ext (1-2 CPU); 1yr SnS
SLES-2S-HA-D3S	SUSE Linux High Availability Ext (1-2 CPU); 3yr SnS
SLES-2S-HA-D5S	SUSE Linux High Availability Ext (1-2 CPU); 5yr SnS
SLES-2S-GC-D1S	SUSE Linux GEO Clustering for HA (1-2 CPU); 1yr Sns
SLES-2S-GC-D3S	SUSE Linux GEO Clustering for HA (1-2 CPU); 3yr SnS
SLES-2S-GC-D5S	SUSE Linux GEO Clustering for HA (1-2 CPU); 5yr SnS
SLES-2S-LP-D1S	SUSE Linux Live Patching Add-on (1-2 CPU); 1yr SnS Required
SLES-2S-LP-D3S	SUSE Linux Live Patching Add-on (1-2 CPU); 3yr SnS Required
SLES and SAP	
SLES-SAP-2S2V-D1S	SLES for SAP Apps (1-2 CPU, 1-2 VM); Priority 1-Yr SnS
SLES-SAP-2S2V-D3S	SLES for SAP Apps (1-2 CPU, 1-2 VM); Priority 3-Yr SnS
SLES-SAP-2S2V-D5S	SLES for SAP Apps (1-2 CPU, 1-2 VM); Priority 5-Yr SnS
SLES-SAP-2S2V-D1A	SLES for SAP Apps w/ HA (1-2 CPU, 1-2 VM); 1-Yr Support Reqd
SLES-SAP-2S2V-D3A	SLES for SAP Apps w/ HA (1-2 CPU, 1-2 VM); 3-Yr Support Reqd
SLES-SAP-2S2V-D5A	SLES for SAP Apps w/ HA (1-2 CPU, 1-2 VM); 5-Yr Support Reqd

STEP 18 CHOOSE OPTIONAL OPERATING SYSTEM MEDIA KIT

Select the optional operating system media listed in [Table 32](#).

Table 32 OS Media

Product ID (PID)	PID Description
MSWS-19-ST16CD-RM	Windows Server 2019 Stan (16 Cores/2 VMs) Rec Media DVD Only
MSWS-19-DC16CD-RM	Windows Server 2019 DC (16Cores/Unlim VM) Rec Media DVD Only
MSWS-22-ST16CD-RM	Windows Server 2022 Stan (16 Cores/2 VMs) Rec Media DVD Only
MSWS-22-DC16CD-RM	Windows Server 2022 DC (16Cores/Unlim VM) Rec Media DVD Only

SUPPLEMENTAL MATERIAL

Block Diagrams

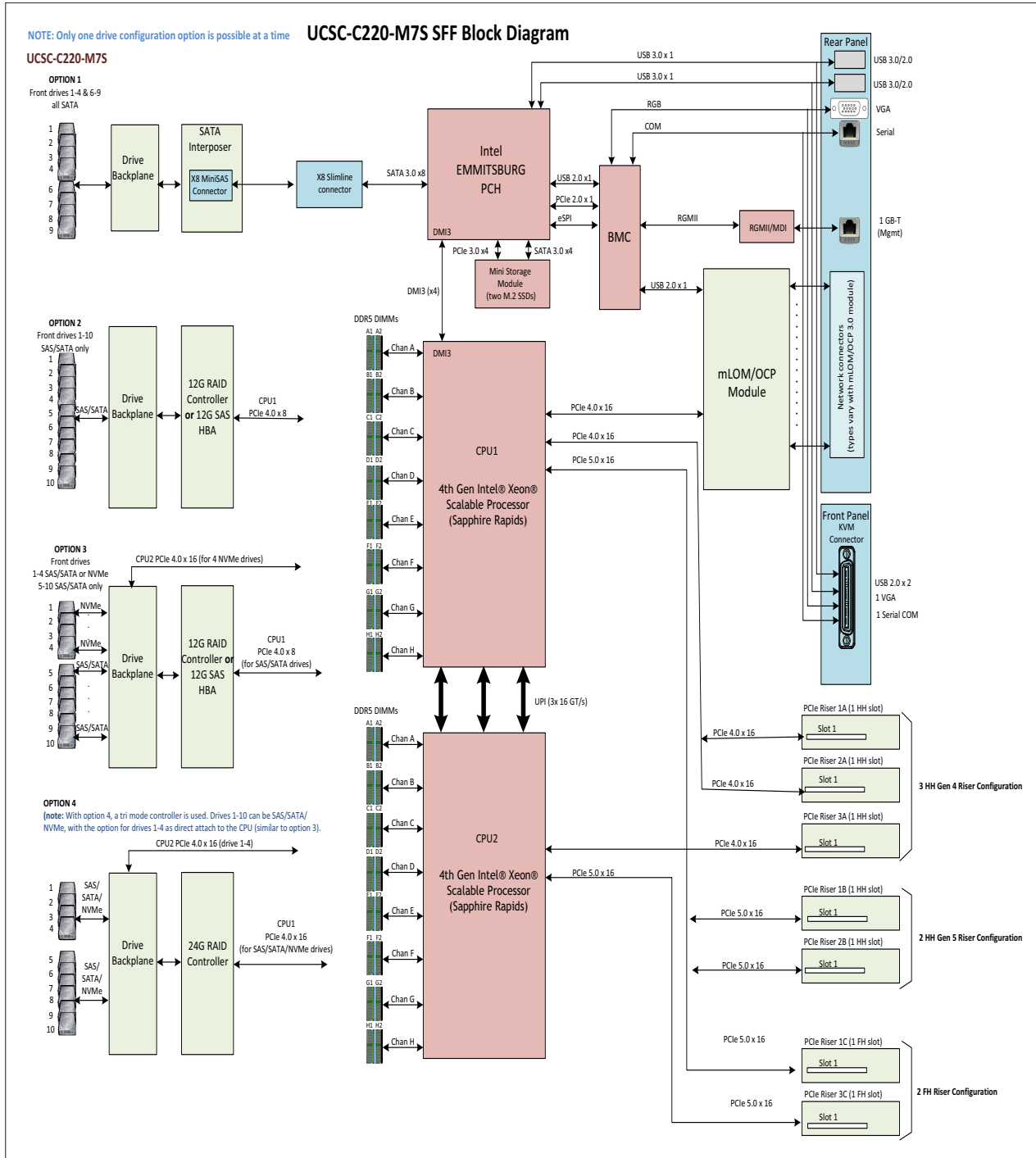

NOTE: Only one drive configuration option is possible at a time

UCSC-C220-M7N SFF Block Diagram

UCSC-C220-M7N

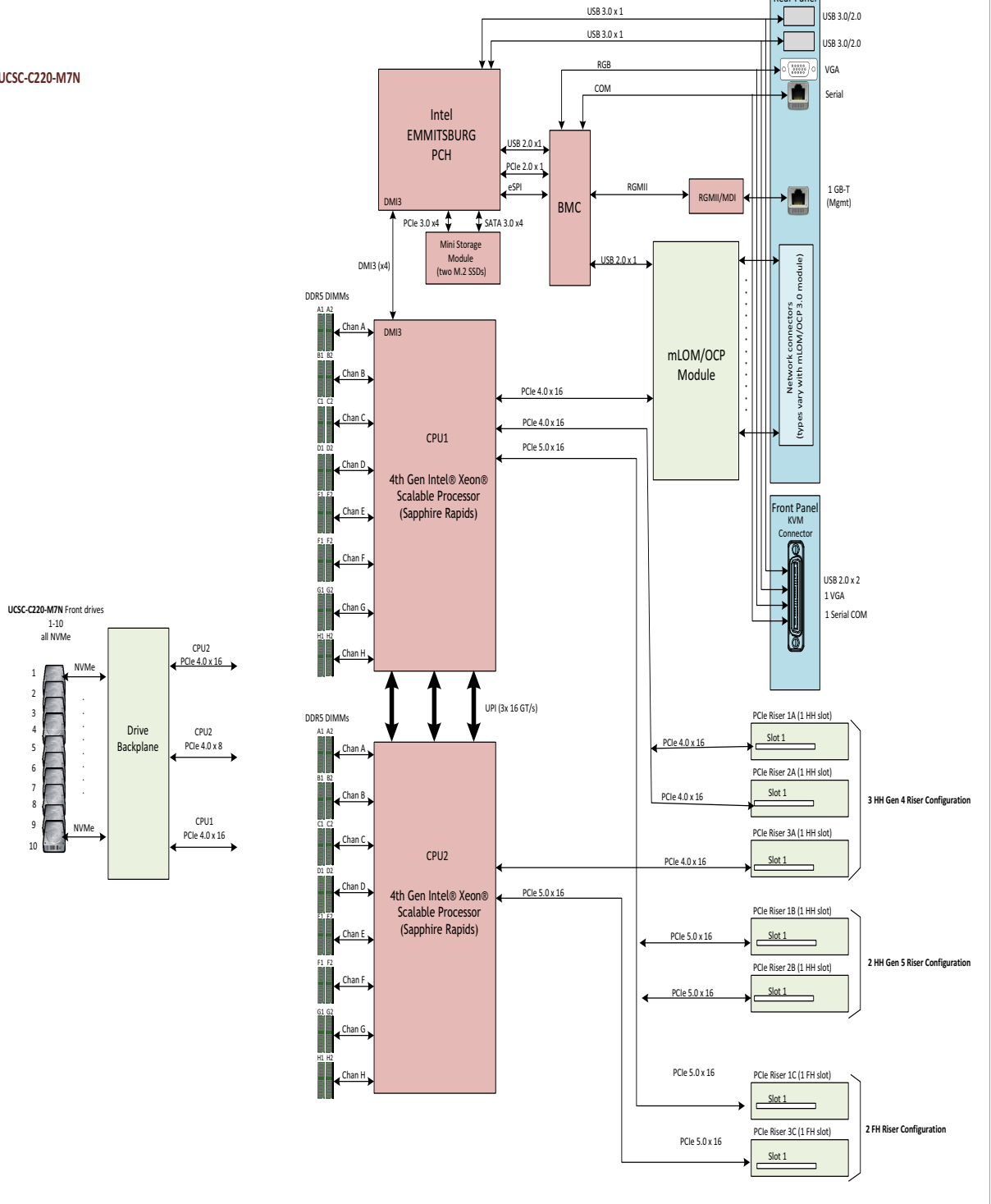

Chassis

Figure 7 and Figure 8 shows the Internal views of the C220 M7 chassis with the top cover removed.

Figure 7 C220 M7 SFF With Top Cover Off (full-height, full-width PCIe cards)

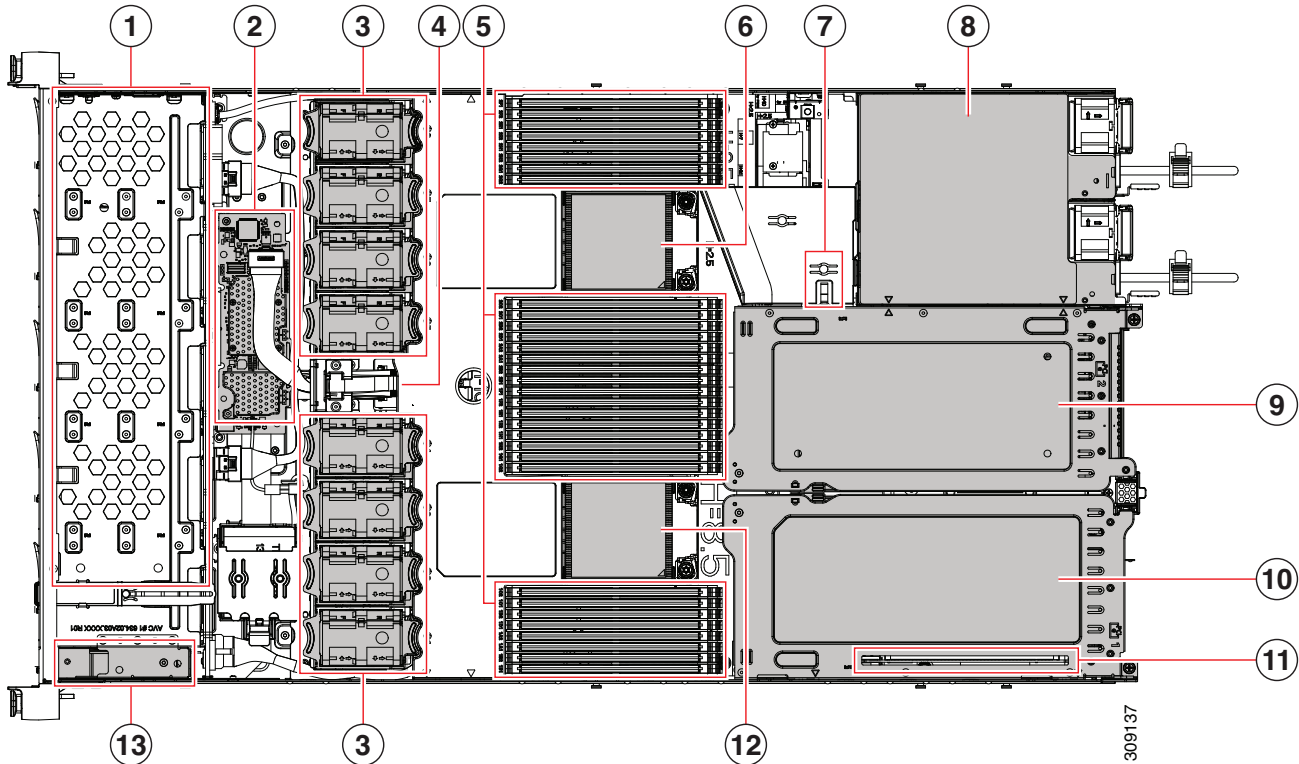

1	Front-loading drive bays	2	M7 modular RAID card (or SATA Interposer)
3	Cooling fan modules (eight) Each fan is hot-swappable	4	Supercap module mounting bracket
5	DIMM sockets on motherboard, 32 total, 16 per CPU CPUs are arranged in groups of eight sockets above the top CPU and below the bottom CPU, and 16 sockets between the CPUs.	6	Motherboard CPU2 socket
7	M.2 module connector, supporting a boot-optimized RAID controller with connectors for up to two SATA M.2 SSDs.	8	Two power supplies
9	PCIe riser 3 Accepts 1 full height, full width PCIe riser card	10	PCIe riser 1 Accepts 1 full height, full width PCIe riser card
11	Modular LOM (mLOM) card bay on chassis floor(x16 PCIe lane) Connector shown, but the card bay sits below PCIe riser 1.	12	Motherboard CPU1 socket
13	Front Panel Controller board	-	

Figure 8 C220 M7 SFF With Top Cover Off (full-height, half-width PCIe cards)

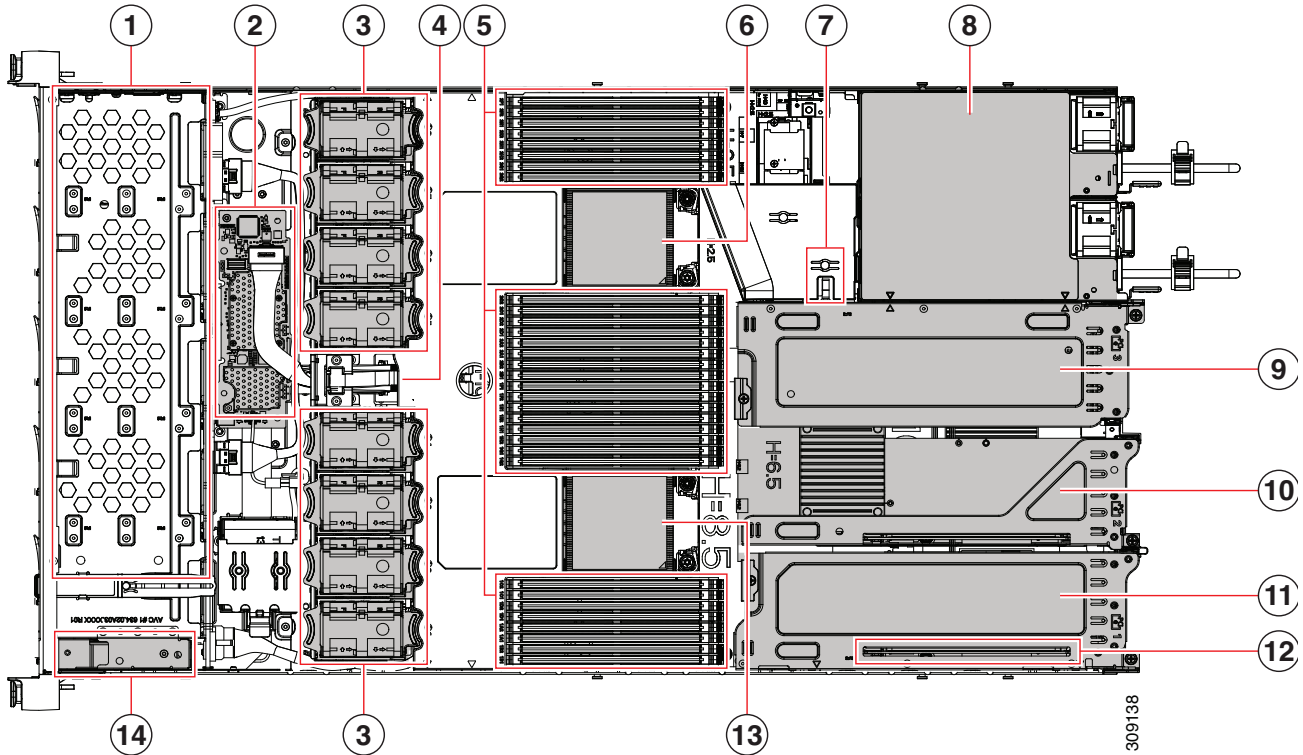

1	Front-loading drive bays	2	M7 modular RAID card (or SATA Interposer)
3	Cooling fan modules (eight) Each fan is hot-swappable	4	Supercap module mounting bracket
5	DIMM sockets on motherboard, 32 total, 16 per CPU CPUs are arranged in groups of eight sockets above the top CPU and below the bottom CPU, and 16 sockets between the CPUs.	6	Motherboard CPU2 socket
7	M.2 module connector, supporting a boot-optimized RAID controller with connectors for up to two SATA M.2 SSDs.	8	Two power supplies
9	PCIe riser 3 Accepts 1 half height, half width PCIe riser card	10	PCIe riser 2 Accepts 1 half height, half width PCIe riser card
11	PCIe riser 1 Accepts 1 half height, half width PCIe riser card	12	Modular LOM (mLOM)/OCP 3.0 card bay on chassis floor (x16 PCIe lane) Connector shown, but the card bay sits below PCIe riser slot 1.
13	Motherboard CPU1 socket	14	Front Panel Controller board

Risers

Figure 9 shows the locations of the PCIe riser connectors on the C220 M7 SFF motherboard. The allowed configurations are:

- Half-height risers in riser 1 connector, riser 2 connector, and riser 3 connector, or
- Full-height risers in riser 1 connector and riser 3 connector.

See *Figure 10* and *Figure 11* for more details.

Figure 9 C220 M7 SFF Riser Connector Locations
C220 M7 SFF Motherboard

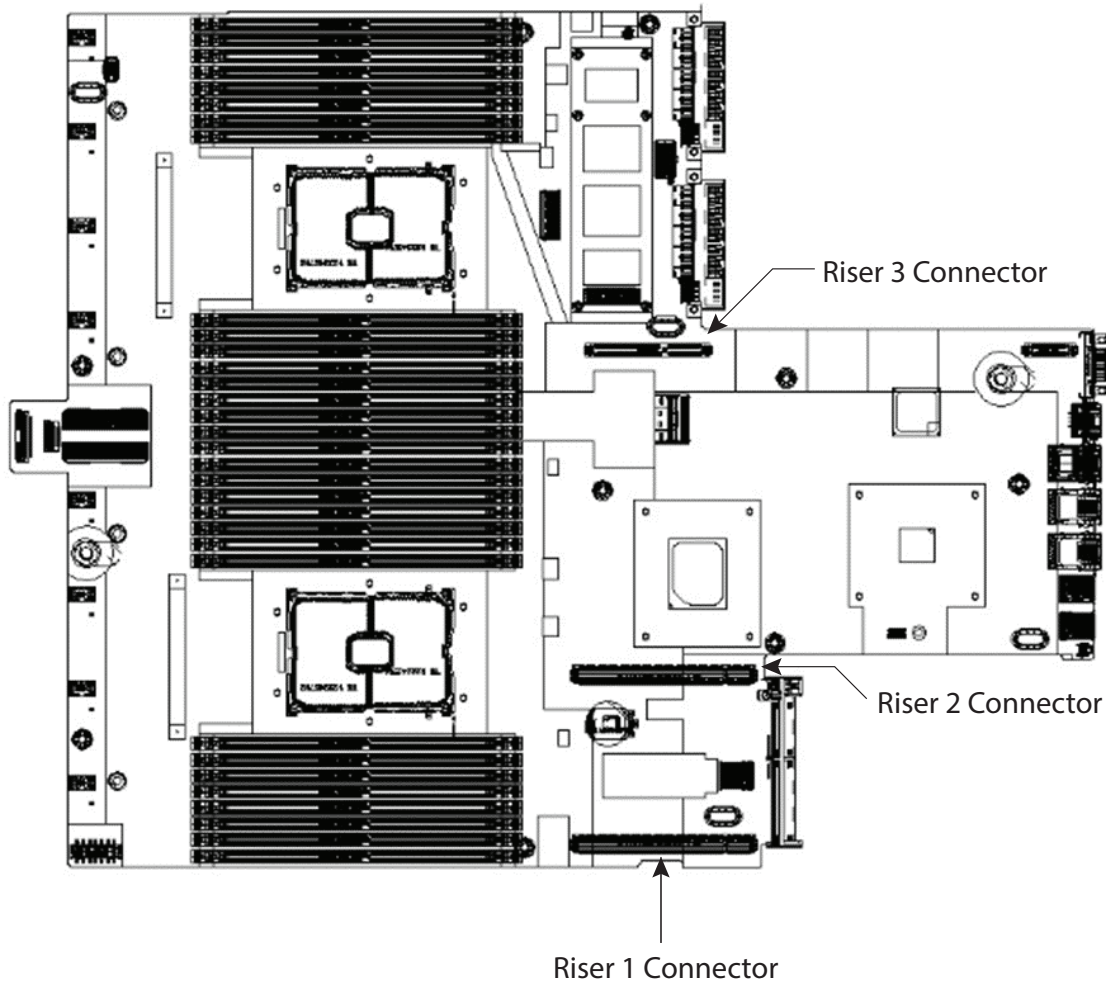

Figure 10 shows three half-height risers plugged into their respective connectors.

Figure 10 C220 M7 SFF With Three Half-Height Risers Plugged In
C220 M7 SFF Motherboard

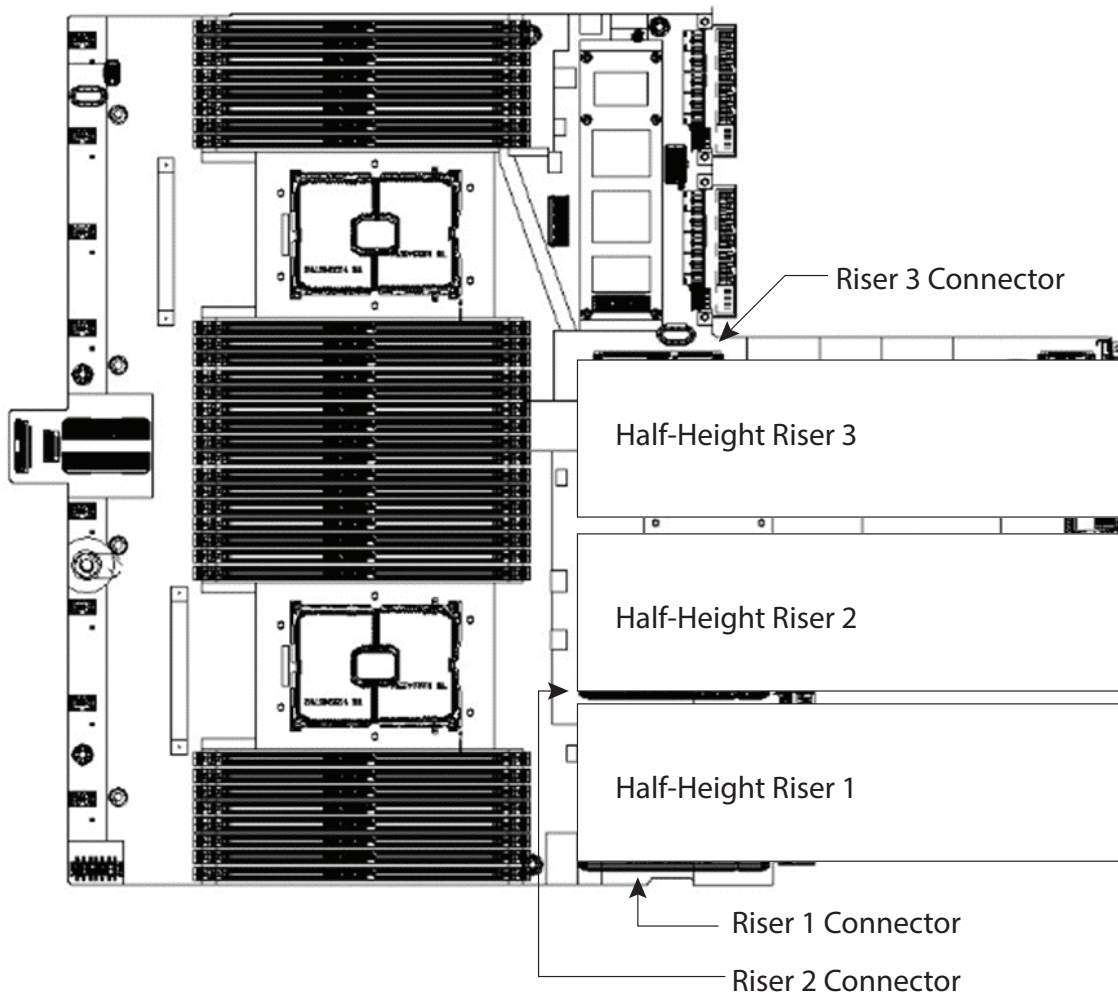
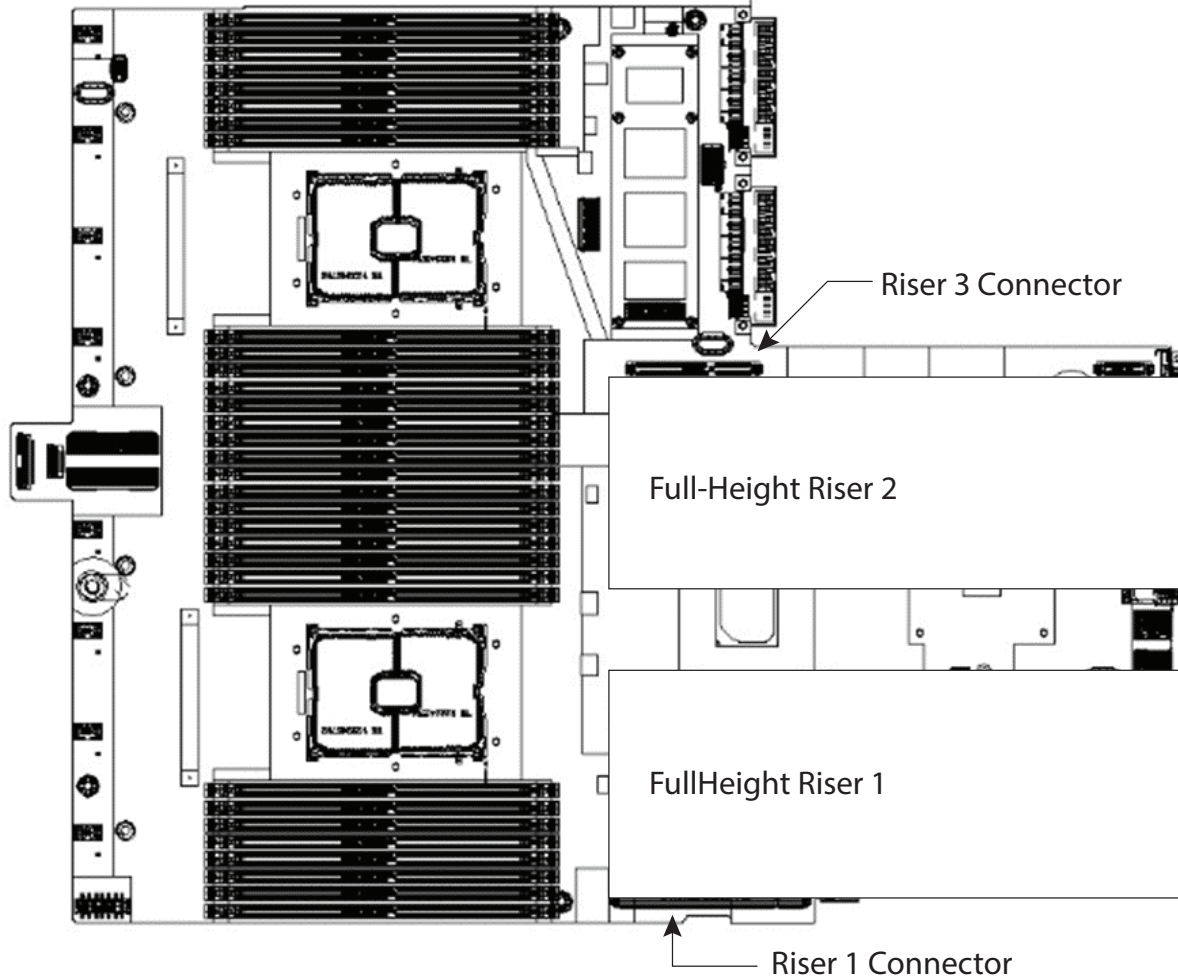

Figure 11 shows two full-height risers plugged in. Note that riser 1 is plugged into the riser 1 connector and riser 2 is plugged into the riser 3 connector. Riser 2 connector is not used.

Figure 11 C220 M7 SFF With Two Full-Height Risers Plugged In
C220 M7 SFF Motherboard



Serial Port Details

The pinout details of the rear RJ-45 serial port connector are shown in [Figure 12](#).

Figure 12 Serial Port (Female RJ-45 Connector) Pinout
Serial Port (RJ-45 Female Connector)

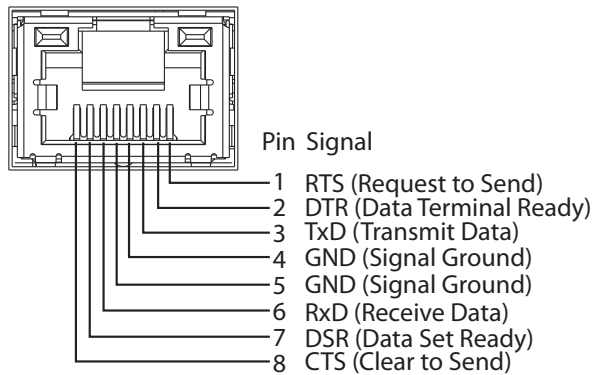

KVM Cable

The KVM cable provides a connection into the server, providing a DB9 serial connector, a VGA connector for a monitor, and dual USB ports for a keyboard and mouse. With this cable, you can create a direct connection to the operating system and the BIOS running on the server.

The KVM cable ordering information is listed in [Table 33](#).

Table 33 KVM Cable

Product ID (PID)	PID Description
N20-BKVM	KVM cable for UCS Server console port

Figure 13 KVM Cable

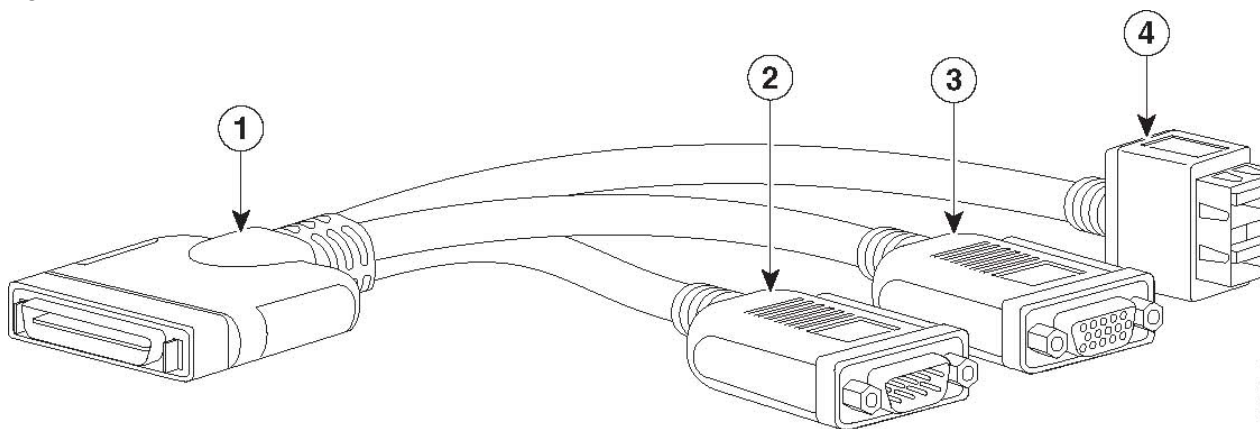

1	Connector (to server front panel)	3	VGA connector (for a monitor)
2	DB-9 serial connector	4	Two-port USB connector (for a mouse and keyboard)

UPGRADING or REPLACING CPUs and Memory

- Refer to [Cisco UCS C220 M7 Server Installation and Service Guide](#) to upgrading or replacing the CPUs
- Refer to [Cisco UCS C220 M7 Server Installation and Service Guide](#) to upgrading or replacing the Memory

SPARE PARTS

This section lists the upgrade and service-related parts for the UCS C220 M7 server. Some of these parts are configured with every server.



NOTE: Some spare parts you order may also require accessories for full functionality. For example, drives or RAID controllers may need accompanying cables. CPUs may need heatsinks, thermal paste, and installation tools. The spares and their accessory parts are listed in [Table 34](#).

Table 34 Spare Parts

Product ID (PID)	Description
Risers	
Riser 1 Option	
UCSC-RIS1A-22XM7=	UCS C-Series M7 1U Riser 1A PCIe Gen4 x16 HH
UCSC-RIS1B-22XM7=	UCS C-Series M7 1U Riser 1B PCIe Gen5 x16 HH
UCSC-RIS1C-22XM7=	UCS C-Series M7 1U Riser 1C PCIe Gen5 x16 FH
Riser 2 Option	
UCSC-RIS2A-22XM7=	UCS C-Series M7 1U Riser 2A PCIe Gen4 x16 HH
UCSC-RIS2B-22XM7=	UCS C-Series M7 1U Riser 2B PCIe Gen5 x16 HH
Riser 3 Option	
UCSC-RIS3A-22XM7=	UCS C-Series M7 1U Riser 3A PCIe Gen4 x16 HH (CPU2)
UCSC-RIS3C-22XM7=	UCS C-Series M7 1U Riser 3C PCIe Gen5 x16 FH (CPU2)
Riser Blank	
UCSC-FBRS2-C220M7=	C220 M7 Riser2 HH Filler Blank
UCSC-FBRS-C220-D=	C220M7 HH Riser3 blank
UCSC-FBRSF-220M7=	C220 M7 Riser FH Filler Blank
CPUs	
<p>Note: If you are ordering a second CPU, see the CPU Accessories section in this table for additional parts you may need to order for the second CPU.</p>	
8000 Series Processors	
UCS-CPU-I8471N=	
UCS-CPU-I8470N=	
UCS-CPU-I8462Y+=	
UCS-CPU-I8461V=	
UCS-CPU-I8460Y+=	
UCS-CPU-I8454H=	
UCS-CPU-I8452Y=	
UCS-CPU-I8450H=	

Table 34 Spare Parts

Product ID (PID)	Description
UCS-CPU-I8444H=	
6000 Series Processors	
UCS-CPU-I6454S=	
UCS-CPU-I6448Y=	
UCS-CPU-I6448H=	
UCS-CPU-I6444Y=	
UCS-CPU-I6442Y=	
UCS-CPU-I6438Y+=	
UCS-CPU-I6438N=	
UCS-CPU-I6438M=	
UCS-CPU-I6434H=	
UCS-CPU-I6434=	
UCS-CPU-I6430=	
UCS-CPU-I6428N=	
UCS-CPU-I6426Y=	
UCS-CPU-I6421N=	
UCS-CPU-I6418H=	
UCS-CPU-I6416H=	
UCS-CPU-I6414U=	
5000 Series Processors	
UCS-CPU-I5420+=	
UCS-CPU-I5418Y=	
UCS-CPU-I5418N=	
UCS-CPU-I5416S=	
UCS-CPU-I5415+=	
UCS-CPU-I5412U=	
UCS-CPU-I5411N=	
4000 Series Processors	
UCS-CPU-I4416+=	
UCS-CPU-I4410Y=	
UCS-CPU-I4410T=	
3000 Series Processors	

Table 34 Spare Parts





Product ID (PID)	Description
UCS-CPU-I3408U=	
CPU Accessories	
UCSC-HSLP-C220M7=  Note: Order this Heatsink, if you are adding additional CPU/spare CPU	UCS C220 M7 Heatsink for & C240 GPU Heatsink
UCS-CPU-TIM=  Note: This part is included with the purchase of spare CPU.Can be ordered separately.	Single CPU thermal interface material syringe for M5 server HS seal ¹
UCS-M6-CPU-CAR=  Note: This part is included with the purchase of spare CPU.Can be ordered separately.	Spare CPU Carrier for M7
UCSX-HSCK=  Note: This part is included with the purchase of spare CPU.Can be ordered separately.	UCS CPU/Heatsink Cleaning Kit, for up to 4 CPU/heatsink sets
UCS-CPUAT=  Note: This part is included with the purchase of spare CPU.Can be ordered separately.	CPU Assembly Tool for Servers
UCSC-FAN-C22XM7=	UCS C-Series M7 1U Fan
Memory	
UCS-MRX16G1RE1=	16GB DDR5-4800 RDIMM 1Rx8 (16Gb)
UCS-MRX32G1RE1=	32GB DDR5-4800 RDIMM 1Rx4 (16Gb)
UCS-MRX64G2RE1=	64GB DDR5-4800 RDIMM 2Rx4 (16Gb)

Table 34 Spare Parts



Product ID (PID)	Description
UCS-MR128G4RE1=	128GB DDR5-4800 RDIMM 4Rx4 (16Gb)
UCS-DDR5-BLK=	UCS DDR5 DIMM Blanks
	Note: Order this DIMM Blank, if you are not using DIMM slots. Any empty DIMM slot must be populated with a DIMM blank to maintain proper cooling airflow.
RAID Controllers	
	Note: When ordering additional RAID controllers, you may need to order a cable/supercap to connect from the RAID controller to the motherboard. See the RAID Controller Accessories section in this table.
UCSC-RAID-HP=	Cisco Tri-Mode 24G SAS RAID Controller w/4GB Cache
UCSC-RAID-HP= accessories (note: the below accessories only required if it is not in the system configuration. Must select all option within a single accessory or OPTOUT PID.	
UCS-SCAP-D=	M6 SuperCap
CBL-SCAP-C220-D=	C220/C240M6 1U/2U Super Cap cable
CBL-SAS-Y-C220M7=	C220M7 SAS CABLE; MB CPU1 P-1 to HP RAID Controller
UCSC-HPBKT-22XM7=	UCS C-Series M7 1U HP RAID Controller Bracket
UCSC-OPTOUT=	Opt out from Ordering Accessories
UCSC-RAID-T-D=	Cisco M6 12G SAS RAID Controller with 4GB FBWC (16 Drives)
UCSC-RAID-T-D= accessories (note: the below accessories only required if it is not in the system configuration. Must select all option within a single accessory or OPTOUT PID.	
UCS-SCAP-D=	M6 SuperCap
CBL-SCAP-C220-D=	C220/C240M6 1U/2U Super Cap cable
CBL-SAS-C220M7=	C220M7 SAS CABLE; MB CPU1 P-1 to SAS RAID Controller
UCSC-RDBKT-22XM7=	UCS C-Series M7 1U RAID/HBA Controller Bracket
UCSC-OPTOUT=	Opt out from Ordering Accessories
UCSC-SAS-T-D=	Cisco M6 12G SAS HBA for (16 Drives)
UCSC-SAS-T-D= accessories (note: the below accessories only required if it is not in the system configuration. Must select all option within a single accessory or OPTOUT PID.	
UCSC-RDBKT-22XM7=	UCS C-Series M7 1U RAID/HBA Controller Bracket
CBL-SAS-C220M7=	C220M7 SAS CABLE; MB CPU1 P-1 to SAS RAID Controller
Controller for External Drives	
UCSC-9500-8E-D=	Cisco 12G 9500-8e 12G SAS HBA for external JBOD attach
SATA Interposer	
UCSC-SATAIN-220M7=	UCS C220 M7 SATA Interposer Board (for control of up to 8 SATA-only drives using AHCI)

Table 34 Spare Parts

Product ID (PID)	Description
Drives	
 <p>Note: When ordering additional SAS/SATA or NVMe front or rear drives, you may need to order a cable to connect from the drive to the motherboard. See the Drive Cables section in this table.</p>	
PCIe/NVMe SFF (2.5-inch) SFF drives	
UCS-NVMEXP-I400-D=	400GB 2.5in U.2 Intel P5800X Optane NVMe Extreme Perform SSD
UCS-NVMEXP-I800-D=	800GB 2.5in U.2 Intel P5800X Optane NVMe Extreme Perform SSD
UCS-NVME4-1600-D=	1.6TB 2.5in U.2 P5620 NVMe High Perf High Endurance
UCS-NVME4-1920-D=	1.9TB 2.5in U.2 P5520 NVMe High Perf Medium Endurance
UCS-NVME4-3200-D=	3.2TB 2.5in U.2 P5620 NVMe High Perf High Endurance
UCS-NVME4-3840-D=	3.8TB 2.5in U.2 P5520 NVMe High Perf Medium Endurance
UCS-NVME4-6400-D=	6.4TB 2.5in U.2 P5620 NVMe High Perf High Endurance
UCS-NVME4-7680-D=	7.6TB 2.5in U.2 P5520 NVMe High Perf Medium Endurance
UCS-NVME4-15360-D=	15.3TB 2.5in U.2 P5520 NVMe High Perf Medium Endurance
UCS-NVMEQ-1536-D=	15.3TB 2.5in U.2 P5316 NVMe High Perf Low Endurance
UCS-NVMEG4-M960-D=	960GB 2.5in U.3 Micron P7450 NVMe High Perf Medium Endurance
UCS-NVMEG4-M1920D=	1.9TB 2.5in U.3 Micron P7450 NVMe High Perf Medium Endurance
UCS-NVMEG4-M3840D=	3.8TB 2.5in U.3 Micron P7450 NVMe High Perf Medium Endurance
UCS-NVMEG4-M7680D=	7.6TB 2.5in U.3 Micron P7450 NVMe High Perf Medium Endurance
UCS-NVMEG4-M1536D=	15.3TB 2.5in U.3 MicronP7450 NVMe High Perf Medium Endurance
UCS-NVMEG4-M1600D=	1.6TB 2.5in U.3 Micron P7450 NVMe High Perf High Endurance
UCS-NVMEG4-M3200D=	3.2TB 2.5in U.3 Micron P7450 NVMe High Perf High Endurance
UCS-NVMEG4-M6400D=	6.4TB 2.5in U.3 Micron P7450 NVMe High Perf High Endurance
HDDs	
HDDs (10K RPM)	
UCS-HD600G10KJ4-D=	600 GB 12G SAS 10K RPM SFF HDD
UCS-HD12TB10KJ4-D=	1.2 TB 12G SAS 10K RPM SFF HDD
UCS-HD18TB10KJ4-D=	1.8 TB 12G SAS 10K RPM SFF HDD (4K)
UCS-HD24TB10KJ4-D=	2.4 TB 12G SAS 10K RPM SFF HDD (4K)
Enterprise Performance SAS/SATA SSDs (High endurance, supports up to 10X or 3X DWPD (drive writes per day))	
SATA	
UCS-SD480G63XEP-D=	480 GB 2.5in Enterprise Performance 6G SATA SSD(3X endurance)
UCS-SD960G63XEP-D=	960 GB 2.5in Enterprise performance 6G SATA SSD(3X endurance)
UCS-SD19T63X-EP-D=	1.9 TB 2.5in Enterprise performance 6G SATA SSD(3X endurance)
UCS-SD38T63X-EP-D=	3.8 TB 2.5in Enterprise performance 6G SATA SSD(3X endurance)
UCS-SD480GBM3XEPD=	480GB SATA SSD 3DWPD
UCS-SD960GBM3XEPD=	960GB SATA SSD 3DWPD
UCS-SD19TBM3XEP-D=	1.9TB SATA SSD 3DWPD

Table 34 Spare Parts

Product ID (PID)	Description
SAS	
UCS-SD800GK3XEP-D=	800 GB 2.5in Enterprise Performance 12G SAS SSD(3X endurance)
UCS-SD16TK3X-EP-D=	1.6 TB 2.5in Enterprise Performance 12G SAS SSD(3X endurance)
UCS-SD32TK3X-EP-D=	3.2 TB 2.5in Enterprise Performance 12G SAS SSD(3X endurance)
UCS-SD16TKA3XEP-D=	1.6TB 2.5in Enterprise Performance 12G SAS SSD(3X endurance)
UCS-SD32TKA3XEP-D=	3.2TB 2.5in Enterprise Performance 12G SAS SSD(3X endurance)
Enterprise Value SAS/SATA SSDs (Low endurance, supports up to 1X DWPD (drive writes per day))	
SATA	
UCSSD480G6I1XEVD=	480GB 2.5 inch Enterprise Value 6G SATA SSD
UCSSD960G6S1XEVD=	960GB 2.5 inch Enterprise Value 6G SATA SSD
UCSSD960G6I1XEVD=	960GB 2.5 inch Enterprise Value 6G SATA SSD
UCS-SD19T6S1XEVD=	1.9TB 2.5 inch Enterprise Value 6G SATA SSD
UCS-SD38T6S1XEVD=	3.8 TB 2.5 inch Enterprise Value 6G SATA SSD
UCS-SD38T6I1XEVD=	3.8TB 2.5 inch Enterprise Value 6G SATA SSD
UCS-SD76T6S1XEVD=	7.6TB 2.5 inch Enterprise Value 6G SATA SSD
UCS-SD240GBM1XEVD=	240GB SATA SSD 1DWPD
UCS-SD480GBM1XEVD=	480GB SATA SSD 1DWPD
UCS-SD960GBM1XEVD=	960GB SATA SSD 1DWPD
UCS-SD16TBM1XEVD=	1.6GB SATA SSD 1DWPD
UCS-SD19TBM1XEVD=	1.9TB SATA SSD 1DWPD
UCS-SD38TBM1XEVD=	3.8TB SATA SSD 1DWPD
UCS-SD76TBM1XEVD=	7.6TB SATA SSD 1DWPD
SAS	
UCS-SD960GK1XEVD=	960GB 2.5 inch Enterprise Value 12G SAS SSD
UCS-SD19TK1X-EV-D=	1.9TB 2.5 inch Enterprise Value 12G SAS SSD
UCS-SD38TK1X-EV-D=	3.8TB 2.5 inch Enterprise Value 12G SAS SSD
UCS-SD76TK1X-EV-D=	7.6TB 2.5 inch Enterprise Value 12G SAS SSD
UCS-SD15TK1X-EV-D=	15.3TB 2.5 inch Enterprise Value 12G SAS SSD
UCS-SD19TKA1XEVD=	1.9TB 2.5 inch Enterprise Value 12G SAS SSD
UCS-SD38TKA1XEVD=	3.8TB 2.5 inch Enterprise Value 12G SAS SSD
UCS-SD76TKA1XEVD=	7.6TB 2.5 inch Enterprise Value 12G SAS SSD
UCS-SD15TKA1XEVD=	15.3TB 2.5 inch Enterprise Value 12G SAS SSD
Self-Encrypted Drives (SED) (1X or 3X)	
SATA	
SAS	
UCS-SD800GBKNK9-D=	800GB Enterprise Performance SAS SSD (3X DWPD, SED) FIPS140-2
UCS-SD960GBKNK9-D=	960GB Enterprise Value SAS SSD (1X DWPD, SED) FIPS140-2
UCS-SD16TBKNK9-D=	1.6TB Enterprise performance SAS SSD (3X DWPD, SED) FIPS140-2
UCS-SD38TBKNK9-D=	3.8TB Enterprise Value SAS SSD (1X DWPD, SED) FIPS140-2

Table 34 Spare Parts



Product ID (PID)	Description
UCS-SD76TBKNK9-D=	7.6TB Enterprise value SAS SSD (1X DWPD, SED-FIPS) FIPS140-2
UCS-SD16TBKANK9-D=	1.6TB 2.5" Enterprise performance 12GSAS SSD(3DWPD, SED-FIPS) FIPS140-2
UCS-SD38TBKANK9-D=	3.8TB 2.5" Enterprise value 12G SAS SSD (1DWPD, SED-FIPS) FIPS140-2
UCS-SD76TBKANK9-D=	7.6TB Enterprise value SAS SSD (1DWPD, SED-FIPS) FIPS140-2
UCS-SD960GM2NK9-D=	960GB SED SSD 1DWPD
UCS-SD19TEM2NK9-D=	1.9TB SED SSD 1DWPD
UCS-SD38TEM2NK9-D=	3.8TB SED SSD 1DWPD
UCS-SD76TEM2NK9-D=	7.6TB SED SSD 1DWPD
Drive Cables	
CBL-SATA-C220-D=	SATA cable C220M7 (1U)
 Note: Order this cable if you are adding a front SAS/SATA drive.	
CBL-FNVME-C220M7=	C220M7 NVMe CABLE; MB to BP (NVMe 1-4) Y-CBL
 Note: You may need to order this cable if you are adding a front NVMe drive to UCSC-C220-M7S	
Drive Blanking Panel	
UCSC-BBLKD-M7	UCS C-Series M7 SFF drive blanking panel
PCIe Cards	
Modular LAN on Motherboard (mLOM)	
UCSC-M-V5Q50G-D=	Cisco UCS VIC 15428 Quad Port 10/25G/50G CNA MLOM
UCSC-M-V5D200G-D=	Cisco UCS VIC 15238 Dual Port 40/100/200G CNA MLOM
UCSC-M-V5Q50GV2-D=	Cisco UCS VIC 15427 Quad Port CNA MLOM with Secure Boot
UCSC-M-V5D200GV2D=	Cisco UCS VIC 15238 Dual Port CNA MLOM with Secure Boot
Open Compute Project (OCP)	
UCSC-O-ID10GC-D=	Intel X710T2LOCPV3G1L 2x10GbE RJ45 OCP 3.0 NIC
Virtual Interface Cards (VICs)	
UCSC-P-V5Q50G-D=	Cisco UCS VIC 15425 Quad Port 10/25/50G CNA PCIE
UCSC-P-V5D200G-D=	Cisco UCS VIC 15235 Dual Port 40/100/200G CNA PCIE
Network Interface Cards (NICs)	
1GB NICs	
UCSC-P-IQ1GC=	Cisco-Intel I710-T4L 4x1GBASE-T NIC
10GB NICs	

Table 34 Spare Parts

Product ID (PID)	Description
UCSC-PCIEID10GF-D=	Intel X710-DA2 Dual Port 10Gb SFP+ NIC
UCSC-PCIEIQ10GF-D=	Intel X710 quad-port 10G SFP+ NIC
UCSC-P-ID10GC-D=	Cisco-Intel X710T2LG 2x10GBE RJ45 PCIe NIC
UCSC-P-IQ10GC-D=	Cisco-Intel X710T4LG 4x10GBE RJ45 PCIe NIC
25GB NICs	
UCSC-P-I8D25GF-D=	Cisco-Intel E810XXVDA2 2x25/10GBE SFP28 PCIe NIC
UCSC-P-I8Q25GF-D=	Cisco-Intel E810XXVDA4L 4x25/10GBE SFP28 PCIe NIC
100GB NICs	
UCSC-P-MCD100GF-D=	Cisco-MLNX MCX623106AC-CDAT 2x100GbE QSFP56 PCIe NIC (with Crypto)
UCSC-P-MDD100GF-D=	Cisco-MLNX MCX623106AS-CDAT 2x100GbE QSFP56 PCIe NIC
UCSC-P-I8D100GF-D=	Cisco-Intel E810CQDA2 2x100 GbE QSFP28 PCIe NIC
Host Bus Adapters (HBAs)	
UCSC-P-Q6D32GF-D=	Cisco-QLogic QLE2772 2x32GFC Gen 6 Enhanced PCIe HBA
UCSC-P-B7D32GF-D=	Cisco-Emulex LPe35002-M2-2x32GFC Gen 7 PCIe HBA
UCSC-PCIEQD16GF-D=	Qlogic QLE2692 dual-port 16G FC HBA
UCSC-PCIEBD16GF-D=	Emulex LPe31002 dual port 16G FC HBA
UCSC-P-Q7D64GF=	Cisco-QLogic QLE2872, 2x64GFC Gen 7 PCIe HBA
External Storage HBA	
UCSC-9500-8E-D=	Cisco 12G 9500-8e 12G SAS HBA for external JBOD attach
GPU	
UCSC-GPU-L4=	NVIDIA L4:70W, 24GB, 1-slot HHL GPU
UCSC-GPU-FLEX140=	Intel GPU Flex 140, Gen4x8, HHL, 75W PCIe
Power Supply	
PSU (Input High Line 210VAC)	
UCSC-PSU1-770W-D=	Cisco UCS 770W AC Power Supply for Rack Server Platinum
UCSC-PSUV21050D-D=	Cisco UCS 1050W -48V DC Power Supply for Rack Server Platinum
UCSC-PSU1-1200W-D=	1200W Titanium power supply for C-Series Servers Titanium
UCSC-PSU1-1600W-D=	1600W AC power supply for C-Series servers Platinum
UCSC-PSU1-2300W-D=	2300W Power supply for C-series servers Titanium
PSU (Input Low Line 110VAC)	
UCSC-PSU1-770W-D=	Cisco UCS 770W AC Power Supply for Rack Server Platinum
UCSC-PSU1-1200W-D=	1200W Titanium power supply for C-Series Servers Titanium
UCSC-PSU1-2300W-D=	2300W Power supply for C-series servers Titanium
Power Cords	
NO-POWER-CORD=	ECO friendly green option, no power cable will be shipped
CAB-48DC40A8AWG-D=	C-Series -48VDC PSU Power Cord, 3.5M, 3 Wire, 8AWG, 40A
CAB-N5K6A-NA=	Power Cord, 200/240V 6A, North America
CAB-AC-L620-C13-D=	AC Power Cord, NEMA L6-20 - C13, 2M/6.5ft

Table 34 Spare Parts

Product ID (PID)	Description
CAB-C13-CBN=	CABASY,WIRE,JUMPER CORD, 27" L, C13/C14, 10A/250V
CAB-C13-C14-2M=	CABASY,WIRE,JUMPER CORD, PWR, 2 Meter, C13/C14,10A/250V
CAB-C13-C14-AC=	CORD,PWR,JMP,IEC60320/C14,IEC6 0320/C13, 3.0M
CAB-250V-10A-AR=	Power Cord, 250V, 10A, Argentina
CAB-9K10A-AU=	Power Cord, 250VAC 10A 3112 Plug, Australia
CAB-250V-10A-CN=	AC Power Cord - 250V, 10A - PRC
CAB-9K10A-EU=	Power Cord, 250VAC 10A CEE 7/7 Plug, EU
CAB-250V-10A-ID=	Power Cord, 250V, 10A, India
CAB-C13-C14-3M-IN=	Power Cord Jumper, C13-C14 Connectors, 3 Meter Length, India
CAB-C13-C14-IN=	Power Cord Jumper,C13-C14 Connectors,1.4 Meter Length, India
CAB-250V-10A-IS=	Power Cord, SFS, 250V, 10A, Israel
CAB-9K10A-IT=	Power Cord, 250VAC 10A CEI 23-16/VII Plug, Italy
CAB-9K10A-SW=	Power Cord, 250VAC 10A MP232 Plug, Switzerland
CAB-9K10A-UK=	Power Cord, 250VAC 10A BS1363 Plug (13 A fuse), UK
CAB-9K12A-NA=	Power Cord, 125VAC 13A NEMA 5-15 Plug, North America
CAB-250V-10A-BR =	Power Cord - 250V, 10A - Brazil
CAB-C13C142M-JP-D=	Power Cord C13-C14, 2M/6.5ft Japan PSE mark
CAB-9K10A-KOR=	Power Cord, 125VAC 13A KSC8305 Plug, Korea
CAB-ACTW=	AC Power Cord (Taiwan), C13, EL 302, 2.3M
CAB-JPN-3PIN=	Japan, 90-125VAC 12A NEMA 5-15 Plug, 2.4m
CAB-48DC40A-INT-D=	C-Series -48VDC PSU PWR Cord, 3.5M, 3 Wire, 8AWG, 40A (INT)
CAB-48DC-40A-AS-D=	C-Series -48VDC PSU PWR Cord, 3.5M, 3Wire, 8AWG, 40A (AS/NZ)
CAB-C19-CBN=	Cabinet Jumper Power Cord, 250 VAC 16A, C20-C19 Connectors
CAB-S132-C19-ISRL=	S132 to IEC-C19 14ft Israeli
CAB-IR2073-C19-AR=	IRSM 2073 to IEC-C19 14ft Argen
CAB-BS1363-C19-UK=	BS-1363 to IEC-C19 14ft UK
CAB-SABS-C19-IND=	SABS 164-1 to IEC-C19 India
CAB-C2316-C19-IT=	CEI 23-16 to IEC-C19 14ft Italy
CAB-L520P-C19-US =	NEMA L5-20 to IEC-C19 6ft US
CAB-US515P-C19-US=	NEMA 5-15 to IEC-C19 13ft US
CAB-US520-C19-US=	NEMA 5-20 to IEC-C19 14ft US
CAB-US620P-C19-US =	NEMA 6-20 to IEC-C19 13ft US
Rail Kit	
UCSC-RAIL-D=	Ball Bearing Rail Kit for C220 & C240 M6/M7 rack servers
UCSC-RAIL-NONE-D=	No rail kit option
UCSC-CMA-C220-D=	Reversible CMA for C220 M6/M7 ball bearing rail kit
Security	

Table 34 Spare Parts

Product ID (PID)	Description
UCSC-DLOM-01-D=	Dedicated Mode BIOS setting for C-Series Servers
UCSC-CCARD-01-D=	Cisco Card Mode BIOS setting for C-Series Servers
UCSX-TPM-002C-D=	Trusted Platform Module 2.0 for UCS servers
UCSC-INT-SW02-D=	C220 and C240 M7 Chassis Intrusion Switch
UCSX-TPM-OPT-OUT-D=	OPT OUT, TPM 2.0, TCG, FIPS140-2, CC EAL4+ Certified
Security	
UCSC-BZL-C220-D=	C220 M7 Security Bezel
M.2 SATA SSD and M.2 RAID controller	
UCS-M2-I240GB-D=	240GB SATA M.2 SSD
UCS-M2-I480GB-D=	480GB SATA M.2 SSD
UCS-M2-240G-D=	240GB M.2 SATA Micron G2 SSD
UCS-M2-960G-D=	960GB M.2 SATA Micron G2 SSD
UCS-M2-HWRAID-D=	Cisco Boot optimized M.2 RAID controller (holds up to two M.2 SATA SSDs)
M.2 NVMe and M.2 RAID controller	
UCS-NVM2-400GB=	400GB M.2 Boot NVMe
UCS-NVM2-960GB=	960GB M.2 Boot NVMe
UCS-M2-NVRAID=	Cisco M.2 NVMe BOOT RAID Controller (HHHL)
Operating system and Software	
VMware vCenter	
VMW-VCS-STD-D1A =	VMware vCenter 7 Server Standard, 1 yr support required
VMW-VCS-STD-D3A=	VMware vCenter 7 Server Standard, 3 yr support required
VMW-VCS-STD-D5A=	VMware vCenter 7 Server Standard, 5 yr support required
VMW-VCS-FND-D1A=	VMware vCenter Server 7 Foundation (4 Host), 1 yr supp reqd
VMW-VCS-FND-D3A=	VMware vCenter Server 7 Foundation (4 Host), 3 yr supp reqd
VMW-VCS-FND-D5A=	VMware vCenter Server 7 Foundation (4 Host), 5 yr supp reqd
Microsoft Windows Server	
MSWS-22-ST16CD =	Windows Server 2022 Standard (16 Cores/2 VMs)
MSWS-22-ST16CD-NS=	Windows Server 2022 Standard (16 Cores/2 VMs) - No Cisco SVC
MSWS-22-DC16CD=	Windows Server 2022 Data Center (16 Cores/Unlimited VMs)
MSWS-22-DC16CD-NS=	Windows Server 2022 DC (16 Cores/Unlim VMs) - No Cisco SVC
MSWS-19-ST16CD=	Windows Server 2019 Standard (16 Cores/2 VMs)
MSWS-19-ST16CD-NS=	Windows Server 2019 Standard (16 Cores/2 VMs) - No Cisco SVC
MSWS-19-DC16CD=	Windows Server 2019 Data Center (16 Cores/Unlimited VMs)
MSWS-19-DC16CD-NS=	Windows Server 2019 DC (16 Cores/Unlim VMs) - No Cisco SVC
Red Hat	
RHEL-2S2V-D1A=	Red Hat Enterprise Linux (1-2 CPU,1-2 VN); 1-Yr Support Req
RHEL-2S2V-D3A=	Red Hat Enterprise Linux (1-2 CPU,1-2 VN); 3-Yr Support Req
RHEL-2S2V-D5A=	Red Hat Enterprise Linux (1-2 CPU,1-2 VN); 5-Yr Support Req
RHEL-VDC-2SUV-D1A=	RHEL for Virt Datacenters (1-2 CPU, Unlim VN) 1 Yr Supp Req

Table 34 Spare Parts

Product ID (PID)	Description
RHEL-VDC-2SUV-D3A=	RHEL for Virt Datacenters (1-2 CPU, Unlim VN) 3 Yr Supp Req
RHEL-VDC-2SUV-D5A=	RHEL for Virt Datacenters (1-2 CPU, Unlim VN) 5 Yr Supp Req
Red Hat Ent Linux/ High Avail/ Res Strg/ Scal	
RHEL-2S2V-D1S=	Red Hat Enterprise Linux (1-2 CPU,1-2 VN); Prem 1Yr SnS Reqd
RHEL-2S2V-D3S=	Red Hat Enterprise Linux (1-2 CPU,1-2 VN); Prem 3Yr SnS Reqd
RHEL-2S-HA-D1S=	RHEL High Availability (1-2 CPU); Premium 1-yr SnS Reqd
RHEL-2S-HA-D3S=	RHEL High Availability (1-2 CPU); Premium 3-yr SnS Reqd
RHEL-2S-RS-D1S=	RHEL Resilent Storage (1-2 CPU); Premium 1-yr SnS Reqd
RHEL-2S-RS-D3S=	RHEL Resilent Storage (1-2 CPU); Premium 3-yr SnS Reqd
RHEL-VDC-2SUV-D1S=	RHEL for Virt Datacenters (1-2 CPU, Unlim VN) 1 Yr SnS Reqd
RHEL-VDC-2SUV-D3S=	RHEL for Virt Datacenters (1-2 CPU, Unlim VN) 3 Yr SnS Reqd
Red Hat SAP	
RHEL-SAP-2S2V-D1S=	RHEL for SAP Apps (1-2 CPU, 1-2 VN); Prem 1-Yr SnS Reqd
RHEL-SAP-2S2V-D3S=	RHEL for SAP Apps (1-2 CPU, 1-2 VN); Prem 3-Yr SnS Reqd
RHEL-SAPSP-D3S=	RHEL SAP Solutions Premium - 3 Years
RHEL-SAPSS-D3S=	RHEL SAP Solutions Standard - 3 Years
VMware	
VMW-VSP-STD-D1A=	VMware vSphere 7 Std (1 CPU, 32 Core) 1-yr, Support Required
VMW-VSP-STD-D3A=	VMware vSphere 7 Std (1 CPU, 32 Core) 3-yr, Support Required
VMW-VSP-STD-D5A=	VMware vSphere 7 Std (1 CPU, 32 Core) 5-yr, Support Required
VMW-VSP-EPL-D1A=	VMware vSphere 7 Ent Plus (1 CPU, 32 Core) 1Yr, Support Reqd
VMW-VSP-EPL-D3A=	VMware vSphere 7 Ent Plus (1 CPU, 32 Core) 3Yr, Support Reqd
VMW-VSP-EPL-D5A=	VMware vSphere 7 Ent Plus (1 CPU, 32 Core) 5Yr, Support Reqd
SUSE	
SLES-2S2V-D1A=	SUSE Linux Enterprise Svr (1-2 CPU,1-2 VM); 1-Yr Support Req
SLES-2S2V-D3A=	SUSE Linux Enterprise Svr (1-2 CPU,1-2 VM); 3-Yr Support Req
SLES-2S2V-D5A=	SUSE Linux Enterprise Svr (1-2 CPU,1-2 VM); 5-Yr Support Req
SLES-2SUVM-D1A=	SUSE Linux Enterprise Svr (1-2 CPU,Unl VM) LP; 1Y Supp Req
SLES-2SUVM-D3A=	SUSE Linux Enterprise Svr (1-2 CPU,Unl VM) LP; 3Y Supp Req
SLES-2SUVM-D5A=	SUSE Linux Enterprise Svr (1-2 CPU,Unl VM) LP; 5Y Supp Req
SLES-2S-LP-D1A=	SUSE Linux Live Patching Add-on (1-2 CPU); 1yr Support Req
SLES-2S-LP-D3A=	SUSE Linux Live Patching Add-on (1-2 CPU); 3yr Support Req
SLES-2S2V-D1S=	SUSE Linux Enterprise Svr (1-2 CPU,1-2 VM); Prio 1-Yr SnS
SLES-2S2V-D3S=	SUSE Linux Enterprise Svr (1-2 CPU,1-2 VM); Prio 3-Yr SnS
SLES-2S2V-D5S=	SUSE Linux Enterprise Svr (1-2 CPU,1-2 VM); Prio 5-Yr SnS
SLES-2SUVM-D1S=	SUSE Linux Enterprise Svr (1-2 CPU,Unl VM) LP; Prio 1Y SnS
SLES-2SUVM-D3S=	SUSE Linux Enterprise Svr (1-2 CPU,Unl VM) LP; Prio 3Y SnS
SLES-2SUVM-D5S=	SUSE Linux Enterprise Svr (1-2 CPU,Unl VM) LP; Prio 5Y SnS
SLES-2S-HA-D1S=	SUSE Linux High Availability Ext (1-2 CPU); 1yr SnS
SLES-2S-HA-D3S=	SUSE Linux High Availability Ext (1-2 CPU); 3yr SnS
SLES-2S-HA-D5S=	SUSE Linux High Availability Ext (1-2 CPU); 5yr SnS

Table 34 Spare Parts

Product ID (PID)	Description
SLES-2S-GC-D1S=	SUSE Linux GEO Clustering for HA (1-2 CPU); 1yr SnS
SLES-2S-GC-D3S=	SUSE Linux GEO Clustering for HA (1-2 CPU); 3yr SnS
SLES-2S-GC-D5S=	SUSE Linux GEO Clustering for HA (1-2 CPU); 5yr SnS
SLES-2S-LP-D1S=	SUSE Linux Live Patching Add-on (1-2 CPU); 1yr SnS Required
SLES-2S-LP-D3S=	SUSE Linux Live Patching Add-on (1-2 CPU); 3yr SnS Required
SLES and SAP	
SLES-SAP-2S2V--D1S=	SLES for SAP Apps (1-2 CPU, 1-2 VM); Priority 1-Yr SnS
SLES-SAP-2S2V-D3S=	SLES for SAP Apps (1-2 CPU, 1-2 VM); Priority 3-Yr SnS
SLES-SAP-2S2V-D5S=	SLES for SAP Apps (1-2 CPU, 1-2 VM); Priority 5-Yr SnS
SLES-SAP-2S2V-D1A=	SLES for SAP Apps w/ HA (1-2 CPU, 1-2 VM); 1-Yr Support Reqd
SLES-SAP-2S2V-D3A=	SLES for SAP Apps w/ HA (1-2 CPU, 1-2 VM); 3-Yr Support Reqd
SLES-SAP-2S2V-D5A=	SLES for SAP Apps w/ HA (1-2 CPU, 1-2 VM); 5-Yr Support Reqd

Notes:

1. This part is included with the purchase of option or spare CPU or CPU processor kits.

TECHNICAL SPECIFICATIONS

Dimensions and Weight

Table 35 UCS C220 M7 Dimensions and Weight

Parameter	Value
Height	1.70 in. (4.3 cm)
Width (including slam latches)	16.9 in.(42.9 cm)
Depth	30 in. (76.2 cm)
Weight	
Weight with following options and no rail kit: 1*HDD, 1*CPU(with Heat Sink), 1*DIMM, 1*1600W PSU, mLOM card, 3HH rear wall, 3HH riser cage1, 3HH riser cage2, 3HH riser cage3, Raid tray, BBU module (with holder)	15.05 kgs = 33.18 lbs (3HH SKU)
Weight with following options and no rail kit: 1*HDD, 1*CPU(with Heat Sink), 1*DIMM, 1*1600W PSU, mLOM card, 2FH rear wall, 2FH riser cage1, 2FH riser cage2, Raid tray, BBU module (with holder)	15.1 kgs = 33.29 lbs (2FH SKU)
Weight with following options and including rail kit: 1*HDD, 1*CPU(with Heat Sink), 1*DIMM, 1*1600W PSU, mLOM card, 3HH rear wall, 3HH riser cage1, 3HH riser cage2, 3HH riser cage3, Raid tray, BBU module (with holder)	18.8 kgs = 41.45 lbs (3HH SKU)
Weight with following options and including rail kit: 1*HDD, 1*CPU(with Heat Sink), 1*DIMM, 1*1600W PSU, mLOM card, 2FH rear wall, 2FH riser cage1, 2FH riser cage2, Raid tray, BBU module (with holder),	18.85 kgs = 41.56 lbs (2FH SKU)
Weight with following options and no rail kit: 10*HDDs, 2*CPUs(with Heat Sink), 32*DIMMs, 2*1600W PSUs, mLOM card, 3HH rear wall, 3HH riser cage1, 3HH riser cage2, 3HH riser cage3, Raid tray, BBU module (with holder)	19.73 kgs = 43.5 lbs (3HH SKU)
Weight with following options and no rail kit: 10*HDDs, 2*CPUs(with Heat Sink), 32*DIMMs, 2*1600W PSUs, mLOM card, 2FH rear wall, 2FH riser cage1, 2FH riser cage2, Raid tray, BBU module (with holder)	19.78 kgs = 43.61 lbs (2FH SKU)
Weight with following options and including rail kit: 10*HDDs, 2*CPUs(with Heat Sink), 32*DIMMs, 2*1600W PSUs, mLOM card, 3HH rear wall, 3HH riser cage1, 3HH riser cage2, 3HH riser cage3, Raid tray, BBU module (with holder)	23.49 kgs = 51.79 lbs (3HH SKU)
Weight with following options and including rail kit: 10*HDDs, 2*CPUs(with Heat Sink), 32*DIMMs, 2*1600W PSUs, mLOM card, 2FH rear wall, 2FH riser cage1, 2FH riser cage2, Raid tray, BBU module (with holder)	23.54 kgs = 51.9 lbs (2FH SKU)

Power Specifications

The server is available with the following types of power supplies:

- 770 W (AC) power supply (see [Table 36](#))
- 1050W DC power supply (see [Table 37](#))
- 1200 W (AC) power supply (see [Table 38](#))
- 1600 W (AC) power supply (see [Table 39](#))
- 2300 W (AC) power supply (see [Table 40](#))

Table 36 UCS C220 M7 770 W (AC) Power Supply Specifications

Parameter	Specification			
Input Connector	IEC320 C14			
Input Voltage Range (Vrms)	100 to 240			
Maximum Allowable Input Voltage Range (Vrms)	90 to 264			
Frequency Range (Hz)	50 to 60			
Maximum Allowable Frequency Range (Hz)	47 to 63			
Maximum Rated Output (W)	770			
Maximum Rated Standby Output (W)	36			
Nominal Input Voltage (Vrms)	100	120	208	230
Nominal Input Current (Arms)	8.8	7.4	4.2	3.8
Maximum Input at Nominal Input Voltage (W)	855	855	855	846
Maximum Input at Nominal Input Voltage (VA)	882	882	882	872
Minimum Rated Efficiency (%) ¹	90	90	90	91
Minimum Rated Power Factor ¹	0.97	0.97	0.97	0.97
Maximum Inrush Current (A peak)	15			
Maximum Inrush Current (ms)	0.2			
Minimum Ride-Through Time (ms) ²	12			

Notes:

1. This is the minimum rating required to achieve 80 PLUS Platinum certification, see test reports published at <http://www.80plus.org/> for certified values
2. Time output voltage remains within regulation limits at 100% load, during input voltage dropout

Table 37 UCS C220 M7 SFF Power Specifications (1050 W V2 DC power supply)

Parameter	Specification
Input Connector	Molex 42820
Input Voltage Range (V rms)	-48
Maximum Allowable Input Voltage Range (V rms)	-40 to -72
Frequency Range (Hz)	NA
Maximum Allowable Frequency Range (Hz)	NA
Maximum Rated Output (W)	1050
Maximum Rated Standby Output (W)	36
Nominal Input Voltage (V rms)	-48
Nominal Input Current (A rms)	24
Maximum Input at Nominal Input Voltage (W)	1154
Maximum Input at Nominal Input Voltage (VA)	1154
Minimum Rated Efficiency (%) ¹	91
Minimum Rated Power Factor ¹	NA
Maximum Inrush Current (A peak)	15
Maximum Inrush Current (ms)	0.2
Minimum Ride-Through Time (ms) ²	5

Notes:

1. This is the minimum rating required to achieve 80 PLUS Platinum certification, see test reports published at <http://www.80plus.org/> for certified values
2. Time output voltage remains within regulation limits at 100% load, during input voltage dropout

Table 38 UCS C220 M7 1200 W (AC) Power Supply Specifications

Parameter	Specification			
Input Connector	IEC320 C14			
Input Voltage Range (Vrms)	100 to 240			
Maximum Allowable Input Voltage Range (Vrms)	90 to 264			
Frequency Range (Hz)	50 to 60			
Maximum Allowable Frequency Range (Hz)	47 to 63			
Maximum Rated Output (W) ¹	1100	1200		
Maximum Rated Standby Output (W)	48			
Nominal Input Voltage (Vrms)	100	120	208	230
Nominal Input Current (Arms)	12.97	10.62	6.47	5.84
Maximum Input at Nominal Input Voltage (W)	1300	1264	1343	1340
Maximum Input at Nominal Input Voltage (VA)	1300	1266	1345	1342
Minimum Rated Efficiency (%) ²	90	90	91	91
Minimum Rated Power Factor ²	0.97	0.97	0.97	0.97
Maximum Inrush Current (A peak)	20			
Maximum Inrush Current (ms)	0.2			
Minimum Ride-Through Time (ms) ³	12			

Notes:

1. Maximum rated output is limited to 1100W when operating at low-line input voltage (100-127V)
2. This is the minimum rating required to achieve 80 PLUS Titanium certification, see test reports published at <http://www.80plus.org/> for certified values
3. Time output voltage remains within regulation limits at 100% load, during input voltage dropout

Table 39 UCS C220 M7 1600 W (AC) Power Supply Specifications

Parameter	Specification			
Input Connector	IEC320 C14			
Input Voltage Range (V rms)	200 to 240			
Maximum Allowable Input Voltage Range (V rms)	180 to 264			
Frequency Range (Hz)	50 to 60			
Maximum Allowable Frequency Range (Hz)	47 to 63			
Maximum Rated Output (W)	1600			
Maximum Rated Standby Output (W)	36			
Nominal Input Voltage (V rms)	100	120	208	230
Nominal Input Current (A rms)	NA	NA	8.8	7.9
Maximum Input at Nominal Input Voltage (W)	NA	NA	1778	1758
Maximum Input at Nominal Input Voltage (VA)	NA	NA	1833	1813
Minimum Rated Efficiency (%) ¹	NA	NA	90	91
Minimum Rated Power Factor ²	NA	NA	0.97	0.97
Maximum Inrush Current (A peak)	30			
Maximum Inrush Current (ms)	0.2			
Minimum Ride-Through Time (ms) ²	12			

Notes:

1. This is the minimum rating required to achieve 80 PLUS Platinum certification, see test reports published at <http://www.80plus.org/> for certified values
2. Time output voltage remains within regulation limits at 100% load, during input voltage dropout

Table 40 UCS C220 M7 2300 W (AC) Power Supply Specifications

Parameter	Specification			
Input Connector	IEC320 C20			
Input Voltage Range (Vrms)	100 to 240			
Maximum Allowable Input Voltage Range (Vrms)	90 to 264			
Frequency Range (Hz)	50 to 60			
Maximum Allowable Frequency Range (Hz)	47 to 63			
Maximum Rated Output (W) ¹	2300			
Maximum Rated Standby Output (W)	36			
Nominal Input Voltage (Vrms)	100	120	208	230
Nominal Input Current (Arms)	13	11	12	10.8
Maximum Input at Nominal Input Voltage (W)	1338	1330	2490	2480
Maximum Input at Nominal Input Voltage (VA)	1351	1343	2515	2505
Minimum Rated Efficiency (%) ²	92	92	93	93
Minimum Rated Power Factor ²	0.99	0.99	0.97	0.97
Maximum Inrush Current (A peak)	30			
Maximum Inrush Current (ms)	0.2			
Minimum Ride-Through Time (ms) ³	12			

Notes:

1. Maximum rated output is limited to 1200W when operating at low-line input voltage (100-127V)
2. This is the minimum rating required to achieve 80 PLUS Titanium certification, see test reports published at <http://www.80plus.org/> for certified values
3. Time output voltage remains within regulation limits at 100% load, during input voltage dropout



NOTE: For configuration-specific power specifications, use the Cisco UCS Power Calculator at this URL: <http://ucspowercalc.cisco.com>

Environmental Specifications

The environmental specifications for Cisco UCS C220 M7 SFF server are listed in [Table 41](#).

Table 41 UCS C220 M7 Environmental Specifications

Parameter	Minimum
Operating Temperature	5 °C to 45 °C (supports ASHRAE Class A4 and/or Class A3 and/or Class A2) ASHRAE Class A3 will be generic test profile unless otherwise specified by product engineering. System shall continue to operate with a single fan failure (one failed impeller in dual impeller housings) across the ASHRAE recommended operating range of 18 °C to 27 °C. While undesired, increased power consumption and/or acoustic noise is permitted during a fan fail event.
Extended Operating Temperature	5 °C to 40 °C (41 °F to 104 °F) with no direct sunlight Humidity condition: Uncontrolled, not to exceed 50% RH starting condition Derate the maximum temperature by 1 °C (33.8 °F) per every 305 meters of altitude above 900m
Non-Operating Temperature	Dry bulb temperature of -40 °C to 65 °C (-40 °F to 149 °F)
Operating Relative Humidity	8% to 90% relative humidity, non-condensing, with maximum wet bulb 28 °C (82.4 °F) within operational temperature range of 5 °C to 50 °C (41 °F to 122 °F)
Non-Operating Relative Humidity	5% to 93% relative humidity, non-condensing, with a maximum wet bulb temperature of 28 °C across the 20 °C to 40 °C dry bulb range.
Maximum Operating Duration	Unlimited
Operating Altitude	A maximum elevation of 3050 meters (10,006 ft)
Non-Operating Altitude	An elevation of 0 to 12,000 meters (39,370 ft)
Sound Power level, Measure A-weighted per ISO7779 LWAd (Bels) Operation at 23 °C (73 °F)	1RU: 5.5B 2RU: 5.8B Racked product: 6.8B
Sound Pressure level, Measure A-weighted per ISO7779 LpAm (dBA) Operation at 23 °C (73 °F)	1RU: 40dB 2RU: 43dB Racked product: 55dB

Extended Operating Temperature Hardware Configuration Limits

Table 42 Cisco UCS C220 M7 Extended Operating Temperature Hardware Configuration Limits

Platform ¹	ASHRAE A3 (5°C to 40°C) ²	ASHRAE A4 (5°C to 45°C) ³
Processors:	155W+	155W+ and 105W+ (4 or 6 Cores)
Memory:	LRDIMMs	LRDIMMs
Storage:	M.2 SATA SSDs NVMe SSDs	M.2 SATA SSDs NVMe SSDs
Peripherals:	PCIe NVMe SSDs GPUs	MRAID PCIe NVMe SSDs GPUs mLOMs/OCP NICs HBAs

Notes:

1. Two PSUs are required and PSU failure is not supported
2. Non-Cisco UCS qualified peripherals and/or peripherals that consume more than 25W are not supported
3. High power or maximum power fan control policy must be applied

Compliance Requirements

The regulatory compliance requirements for C-Series servers are listed in [Table 43](#).

Table 43 UCS C-Series Regulatory Compliance Requirements

Parameter	Description
Regulatory Compliance	Products should comply with CE Markings per directives 2014/30/EU and 2014/35/EU
Safety	UL 60950-1 / 62368-1 CAN/CSA-C22.2 No. 60950-1, CAN/CSA-C22.2 No. 62368-1 EN 60950-1 / EN 62368-1 IEC 60950-1 / IEC 62368-1 AS/NZS 60950-1/62368.1 GB4943
EMC - Emissions	47CFR Part 15 (CFR 47) Class A AS/NZS CISPR32 Class A CISPR32 Class A EN55032 Class A ICES003 Class A VCCI Class A EN61000-3-2 EN61000-3-3 KN32 Class A CNS13438 Class A
EMC - Immunity	EN55024 CISPR24 EN300386 KN35



Americas Headquarters
Cisco Systems, Inc.
San Jose, CA

Asia Pacific Headquarters
Cisco Systems (USA) Pte. Ltd.
Singapore

Europe Headquarters
Cisco Systems International BV Amsterdam,
The Netherlands

Cisco has more than 200 offices worldwide. Addresses, phone numbers, and fax numbers are listed on the Cisco Website at www.cisco.com/go/offices.

Cisco and the Cisco Logo are trademarks of Cisco Systems, Inc. and/or its affiliates in the U.S. and other countries. A listing of Cisco's trademarks can be found at www.cisco.com/go/trademarks. Third party trademarks mentioned are the property of their respective owners. The use of the word partner does not imply a partnership relationship between Cisco and any other company. (1005R)