



ACX5448, ACX5448-D, and ACX5448-M Universal Metro Routers Quick Start Guide

IN THIS GUIDE

- ACX5448, ACX5448-D, and ACX5448-M Router Description | 1
- Step 1: Prepare the Site for Installing an ACX5400 Router | 7
- Step 2: Install the ACX5400 Chassis in the Rack | 11
- Step 3: Connect the Grounding Cable | 16
- Step 4: Connect Power Cables | 18
- Step 5: Connect External Devices and Cables | 25
- Step 6: Perform Initial Software Configuration | 28
- Safety Warnings | 32
- Compliance Statements for NEBS | 33
- Compliance Statements for EMC Requirements | 34
- Contacting Customer Support | 35

ACX5448, ACX5448-D, and ACX5448-M Router Description

IN THIS SECTION

- ACX5448 System Overview | 2
- ACX5448-D System Overview | 3
- ACX5448-M System Overview | 5



This Quick Start Guide contains information you need to install and configure the router quickly. For complete installation instructions, see the *ACX5448, ACX5448-D, and ACX5448-M Universal Metro Routers Hardware Guide* at <https://www.juniper.net/documentation/>, or scan the QR code at the bottom of the page to go directly to the router product page.

The Juniper Networks ACX5400 Universal Metro Routers are top-of-rack routers with deep packet buffer solutions for metro network or aggregation environments. The ACX5400 router portfolio consists of high-performance, fixed-configuration, 1-U routers that add higher port densities, additional scalability, and improved latency to the ACX Series. The routers have a high-throughput Packet Forwarding Engine, which provides full duplex throughput of 800 Gbps. The 1.9 Ghz six-core Intel CPU with 32 GB of memory and two 100 GB of enterprise-grade solid-state drive (SSD) storage enhance the performance of the ACX5400 control plane.

We ship these routers with redundant fans and redundant power supply modules (PSMs). You can order the routers with front-to-back airflow (airflow out or AFO) or back-to-front airflow (airflow in or AFI), and with AC or DC PSMs.

The ACX5400 routers are available in three variants:

- ACX5448
- ACX5448-D
- ACX5448-M

ACX5448 System Overview

The ACX5448 router provides a system throughput of up to 800 Gbps through the following port configurations:

- Forty-eight 10-Gigabit or 1-Gigabit Ethernet ports (ports **0** through **47**) that support small form-factor pluggable plus (SFP+) transceivers. These ports can also operate at 1-Gbps speed when you use 1-gigabit SFP optics.
- Four 100-Gigabit Ethernet ports (ports **48** through **51**) that support quad small form-factor pluggable 28 (QSFP28) transceivers. You can channelize these ports into four 25-Gbps interfaces using breakout cables (and channelization configuration). These ports also support 40-Gbps speed, when you use QSFP+ optics. You can channelize these 40-Gbps ports into four 10-Gbps interfaces using breakout cables (and channelization configuration).

[Figure 1](#) shows the front of the ACX5448 router.

Figure 1: Front View of the ACX5448 Router

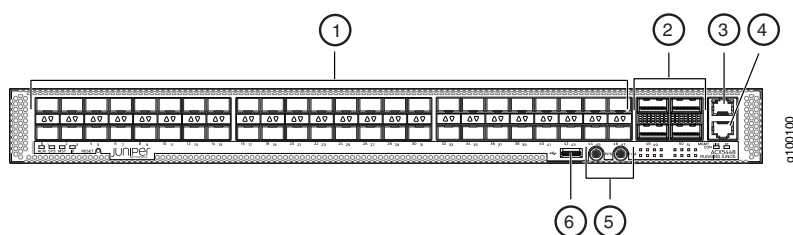

1–1-Gigabit/10-Gigabit Ethernet ports (48 SFP+ or SFP ports)	4–Console (CON) port
2–100-Gigabit Ethernet ports (4 QSFP28 ports)	5–1-PPS and 10-MHz GPS output ports
3–Management (MGMT) port	6–USB port

Figure 2 and Figure 3 present rear views of the fully configured ACX5448 routers, one with AC power and the other with DC power.

Figure 2: Rear View of the AC-Powered ACX5448 Router

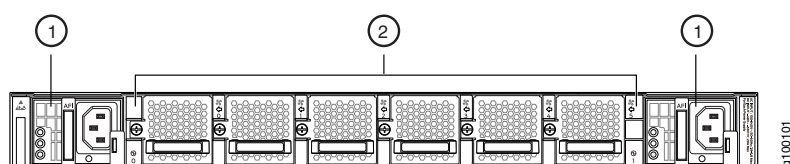

1–Power supply modules (AC)	2–Fan modules
-----------------------------	---------------

Figure 3: Rear View of the DC-Powered ACX5448 Router

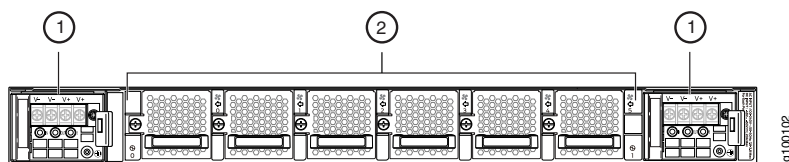

1–Power supply modules (DC)	2–Fan modules
-----------------------------	---------------

ACX5448-D System Overview

The ACX5448-D router provides a system throughput of up to 800 Gbps through the following port configurations:

- Thirty-six 10-Gigabit or 1-Gigabit Ethernet ports (0 through 35, mapped to CLI PIC 0) that support SFP+ transceivers. These ports can also operate at 1-Gbps speed when you use 1-gigabit SFP optics.

- Two 100-Gigabit Ethernet ports (36 and 37, mapped to CLI PIC 1) that support QSFP28 transceivers. You can channelize each of these ports into four 25-Gbps interfaces using breakout cables (and channelization configuration). These ports also support 40-Gbps speed, when you use QSFP+ optics. You can then channelize each of these 40-Gbps ports into four 10-Gbps interfaces using breakout cables (and channelization configuration).
- Two 200-Gigabit Ethernet ports (38 and 39, mapped to logical PIC 2) that support 200-gigabit CFP2-DCO transceivers.

NOTE: One QSFP28 port (port 36) and one CFP2-DCO port (port 38) can operate as multiplexer ports.

Figure 4 shows the front of the ACX5448-D router.

Figure 4: Front View of the ACX5448-D Router

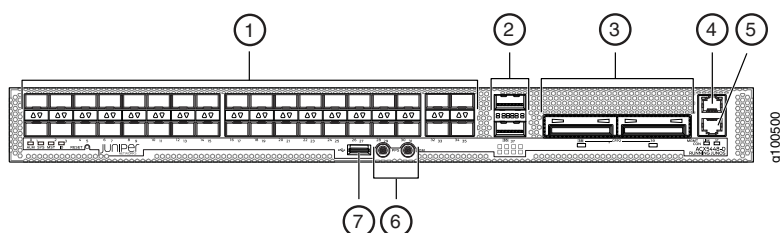

1–1- Gigabit/10-Gigabit Ethernet ports (36 SFP+ or SFP ports)	5–Console (CON) port
2–100-Gigabit Ethernet ports (2 QSFP28 ports)	6–PPS and 10M GPS output ports
3–100-Gigabit/200-Gigabit Ethernet ports (2 CFP2-DCO ports)	7–USB port
4–Management (MGMT) port	

Figure 5 and Figure 6 present rear views of the fully configured ACX5448-D routers, one with AC power and the other with DC power.

Figure 5: Rear View of the AC-Powered ACX5448-D Router

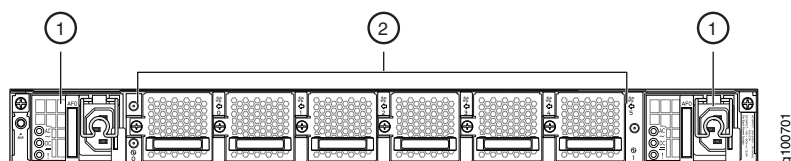

1–Power supply modules (AC)	2–Fan modules
-----------------------------	---------------

Figure 6: Rear View of the DC-Powered ACX5448-D Router

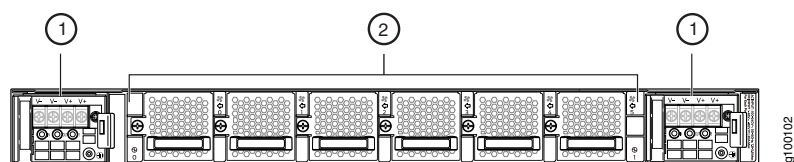

1—Power supply modules (DC)

2—Fan modules

ACX5448-M System Overview

The ACX5448-M router provides a system throughput of up to 800 Gbps through the following port configuration:

- Forty-four 10-Gigabit Ethernet ports (**0** through **43**) that support SFP+ transceivers. These ports can also operate at 1-Gbps speed when you use 1-gigabit SFP optics.
- Six 100-Gigabit Ethernet ports (**44** through **49**) that support QSFP28 transceivers. You can channelize each of these ports into four 25-Gbps interfaces using breakout cable (and channelization configuration). These ports also support 40-Gbps speed, when you use QSFP+ optics. You can then channelize each of these 40-Gbps ports into four 10-Gbps interfaces using breakout cable (and channelization configuration).

NOTE: The ACX5448-M routers support advanced security capabilities such as Media Access Control Security (MACsec). MACsec is supported only on the forty-four 10-Gigabit or 1-Gigabit Ethernet ports.

Figure 7 shows the front of the ACX5448-M router.

Figure 7: Front View of the ACX5448-M Router

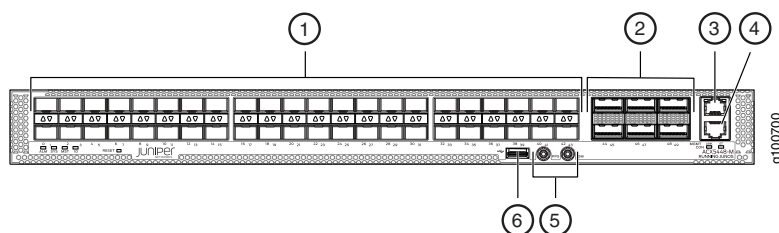

1—1-Gigabit/10-Gigabit Ethernet ports (44 SFP+ or SFP ports)

4—Console (**CON**) port

2—100-Gigabit Ethernet ports (6 QSFP28 ports)

5—**PPS** and **10M** GPS output ports3—Management (**MGMT**) port

6—USB port

Figure 8 and Figure 9 present rear views of the fully configured ACX5448-M routers, one with AC power and the other with DC power.

Figure 8: Rear View of the AC-Powered ACX5448-M Router

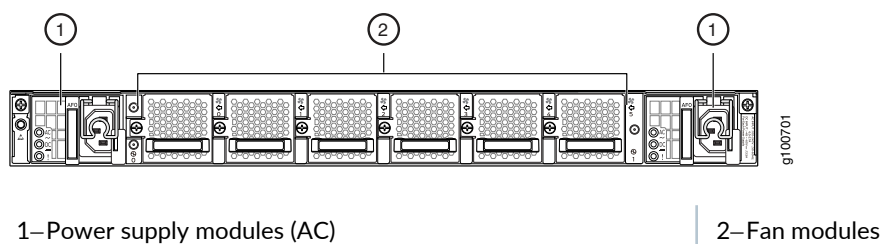
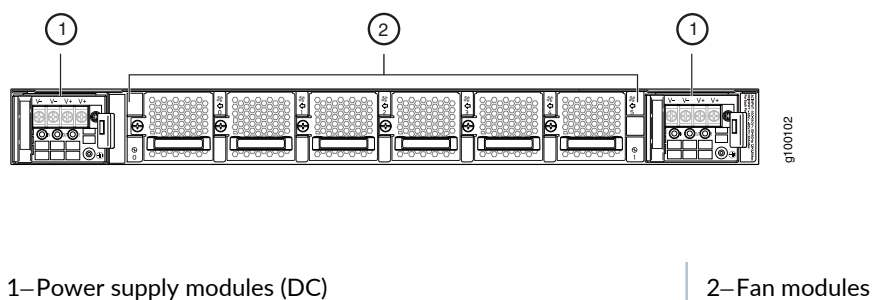

Figure 9: Rear View of the DC-Powered ACX5448-M Router



The electrostatic discharge (ESD) point on the router is located on the rear of the chassis. [Figure 10](#) shows the ESD point on the ACX5448 router and [Figure 11](#) shows the ESD point on the ACX5448-D and ACX5448-M routers.



CAUTION: Before removing or installing components, attach an ESD strap to an ESD point, and wrap and fasten the other end of the strap around your bare wrist. Failure to use an ESD strap can result in damage to the hardware components.



WARNING: This Quick Start contains a summary of safety warnings in [“Safety Warnings” on page 32](#). For a complete list of warnings for this router, including translations, see the *ACX5448 Universal Metro Router Hardware Guide*.

Figure 10: ESD Point on the ACX5448 Router

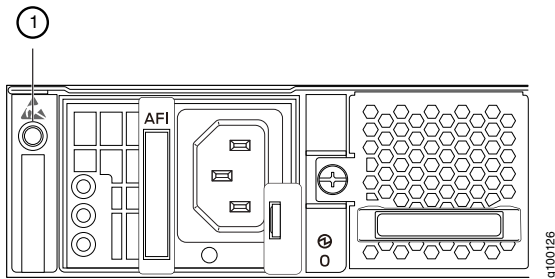

1—ESD point

Figure 11: ESD Point on the ACX5448-D and ACX5448-M Router

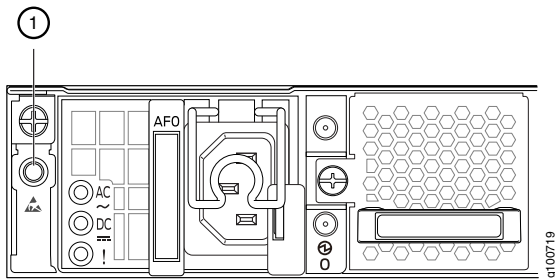

1—ESD point

Step 1: Prepare the Site for Installing an ACX5400 Router

IN THIS SECTION

- [Rack Requirements for ACX5400 Routers | 7](#)
- [Router Clearance Requirements | 8](#)
- [Router Cooling and Airflow Requirements | 10](#)
- [Tools Required to Prepare the ACX5400 Router for Installation | 11](#)

Rack Requirements for ACX5400 Routers

The ACX5400 routers are designed to be installed on four-post racks.

[Table 1](#) provides the rack requirements and specifications for ACX5400 routers.

Table 1: Rack Requirements for ACX5400 Routers

Rack Requirement	Guidelines
Rack type	<p>Use a four-post rack that provides bracket holes or hole patterns spaced at 1-U increments (1.75 in. or 4.45 cm) and that the rack meets the size and strength requirements to support the weight.</p> <p>A U is the standard rack unit defined in <i>Cabinets, Racks, Panels, and Associated Equipment</i> (document number EIA-310-D) published by the Electronics Industry Association.</p>
Mounting bracket hole spacing	<p>Ensure that the holes in the mounting brackets are spaced at 1 U (1.75 in. or 4.45 cm) so that the router can be mounted in any rack that provides holes spaced at that distance.</p>
Rack size and strength	<ul style="list-style-type: none"> • Ensure that the rack complies with the standards for a 19-in. rack as defined in <i>Cabinets, Racks, Panels, and Associated Equipment</i> (document number EIA-310-D) published by the Electronics Industry Association. • Use an 800-mm rack as defined in the four-part <i>Equipment Engineering (EE) European telecommunications standard for equipment practice</i> (document numbers ETS 300 119-1 through 119-4) published by the European Telecommunications Standards Institute (http://www.etsi.org). <p>The horizontal spacing between the rails in a rack that complies with this standard is usually wider than the device's mounting brackets, which measure 19 in. (48.26 cm) from outer edge to outer edge. Use approved wing devices to narrow the opening between the rails as required.</p> <ul style="list-style-type: none"> • Ensure that the rack rails are spaced widely enough to accommodate the router chassis' external dimensions. The outer edges of the front-mounting brackets extend the width to 19 in. (48.26 cm). • Ensure that for four-post installations, the front and rear rack rails are spaced between 23.6 in. (60 cm) and 36 in. (91.4 cm) front-to-back. • Ensure that the rack is strong enough to support the weight of the router. The fully configured ACX5448 router weighs about 22.48 lb (10.2 kg), the ACX5448-D router weighs 23.14 lb (10.5 kg), and the ACX5448-M router weighs 26.12 lb (11.85 kg). • Ensure that the spacing of rails and adjacent racks allows for proper clearance around the router and rack.
Rack connection to building structure	<ul style="list-style-type: none"> • Secure the rack to the building structure. • If earthquakes are a possibility in your geographical area, secure the rack to the floor. • Secure the rack to the ceiling brackets as well as wall or floor brackets for maximum stability.

Router Clearance Requirements

For the cooling system to function properly, the airflow around the chassis must be unrestricted. You must allow sufficient clearance around the installed chassis for cooling and maintenance.

If you are mounting an ACX5400 in a rack with other equipment, ensure that the exhaust from the other equipment does not blow into the intake vents of the ACX5400 chassis.

For service personnel to remove and install hardware components, and to accommodate the interface and power cable bend radius, there must be adequate space at the front and rear of the router. Allow at least 24 in. (61 cm) of space both at the front and the rear of the router. See [Figure 12](#) for clearance requirements in ACX5448 and ACX5448-D routers and [Figure 13](#) for clearance requirements in ACX5448-M routers.

Figure 12: Clearance Requirements for Airflow and Hardware Maintenance for ACX5448 and ACX5448-D Routers

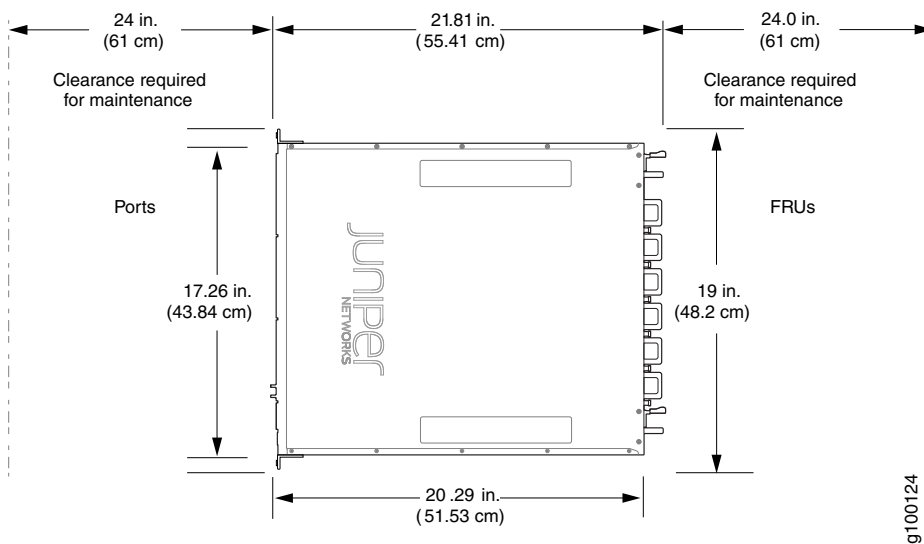
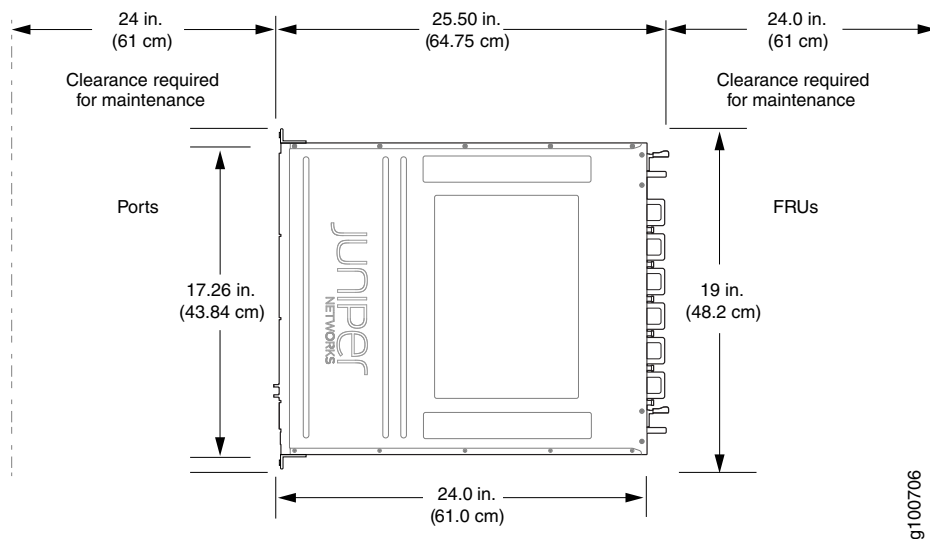

Figure 13: Clearance Requirements for Airflow and Hardware Maintenance for ACX5448-M Routers



Router Cooling and Airflow Requirements

- The ACX5400 routers are available with either front-to-back airflow (airflow out, ports-to-FRUs, or AFO), or back-to-front airflow (airflow in, FRUs-to-ports, or AFI). In AFO models, the air is pulled through the front of the chassis toward the fan modules, from where it is exhausted out of the chassis. In AFI models, the air is pulled through the fan modules and toward the front of the chassis, from where it is exhausted out of the chassis. The fan modules and the power supply modules (PSMs) are available in both AFO and AFI variants. [Figure 14](#) and [Figure 15](#) show the airflow through the two router models.
- For the cooling system to function properly, the airflow around the chassis must be unrestricted.
- The PSMs are self-cooling and are located in the rear of the router. The exhaust for the PSMs are also located on the rear of the chassis.
- The rack or cabinet must have an adequate supply of cooling air.

Figure 14: Air Out Airflow (AFO) Through the ACX5400 Chassis

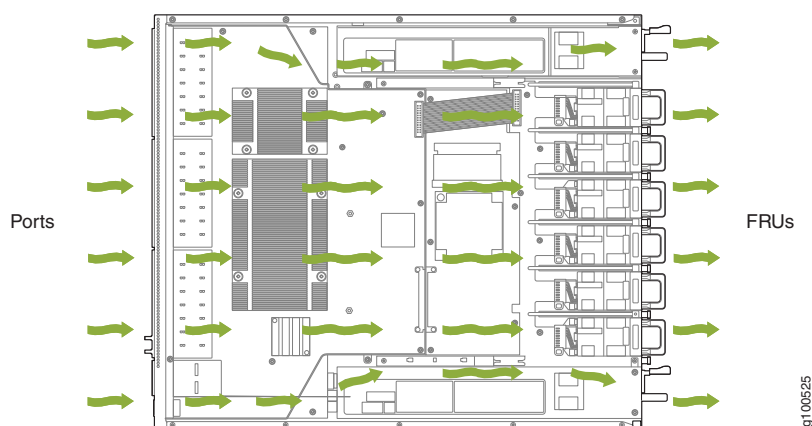
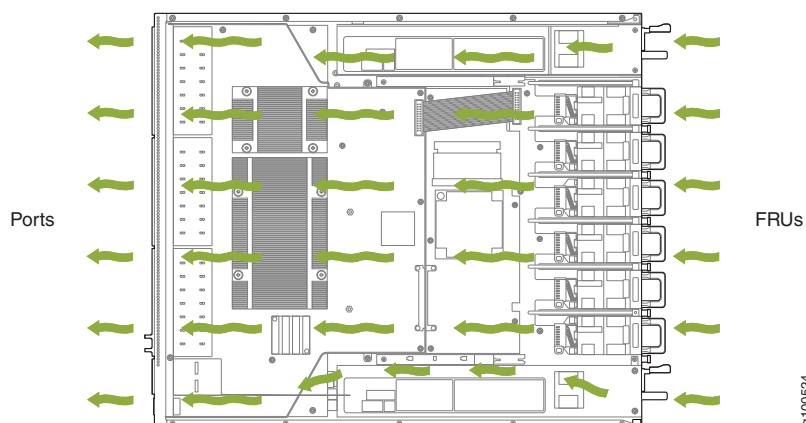

Figure 15: Air In Airflow (AFI) Through the ACX5400 Chassis





CAUTION: Do not mix different types of airflow modules in the same chassis. The fan modules and PSMs must be of the same airflow type (AFO or AFI).

Tools Required to Prepare the ACX5400 Router for Installation

- ESD grounding strap (not provided).
- One pair of rear-mounting blades (provided). These mounting blades support the rear of the chassis and must be installed.
- One pair of front-mounting rails, with mounting brackets attached at one end (provided). The mounting rails accommodate the mounting blades that slide into the rails.
- Twelve screws to secure the mounting rails to the chassis (provided).
- Eight screws to secure the chassis and mounting blades to the rack (not provided).
- Appropriate screwdriver for the mounting screws (not provided).
- Two power cords with plugs appropriate for your geographical location (provided).
- RJ-45 cable and RJ-45 to DB-9 serial port adapter (provided).
- Management host, such as a PC laptop, with a serial port (not provided).

Step 2: Install the ACX5400 Chassis in the Rack

To install the router in a four-post rack or cabinet:

1. Position the router in front of the rack or cabinet.
2. Wrap and fasten one end of the ESD grounding strap around your bare wrist, and connect the other end of the strap to the ESD point on the chassis.
3. Align the holes in the front-mounting rails with the holes on the side of the chassis (see [Figure 16](#) for ACX5448, [Figure 17](#) for ACX5448-D, and [Figure 18](#) for ACX5448-M).

Figure 16: Install Mounting Rails on an ACX5448 Router

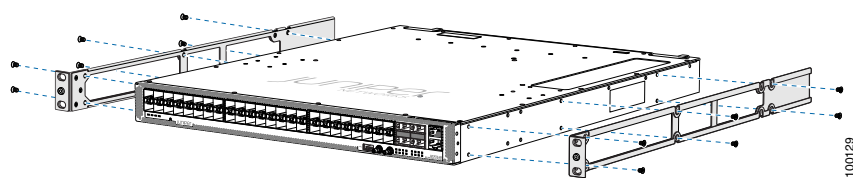

Figure 17: Install Mounting Rails on an ACX5448-D Router

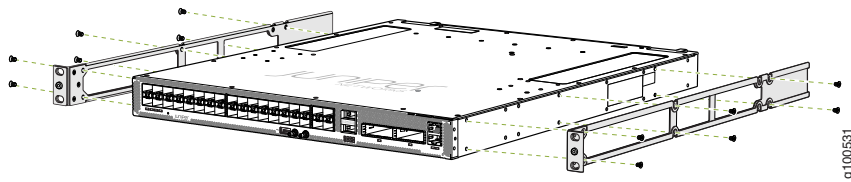
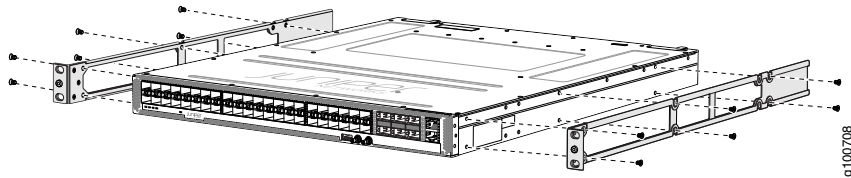

Figure 18: Install Mounting Rails on an ACX5448-M Router



4. Using a Phillips (+) number 2 screwdriver and the mounting screws, secure the mounting rails to the chassis.
5. With one person on each side, hold on to the bottom of the chassis and carefully lift it so that the mounting rails contact the rack rails.
6. Carefully slide the chassis with the rails attached on to the rack rails (see [Figure 19](#) for the ACX5448 router, [Figure 20](#) for the ACX5448-D router, and [Figure 21](#) for ACX5448-M router).

Figure 19: Install the ACX5448 Router in a Four-Post Rack

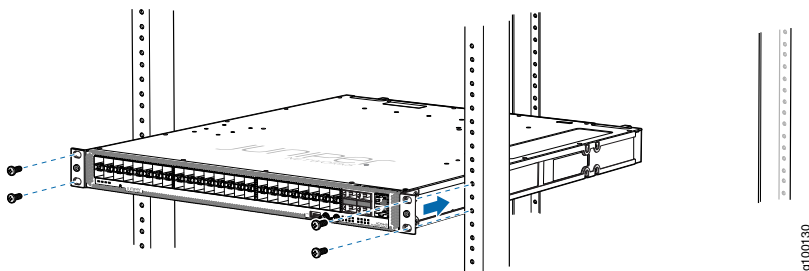

Figure 20: Install the ACX5448-D Router in a Four-Post Rack

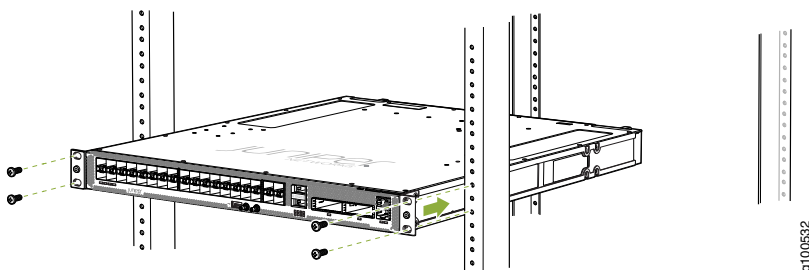
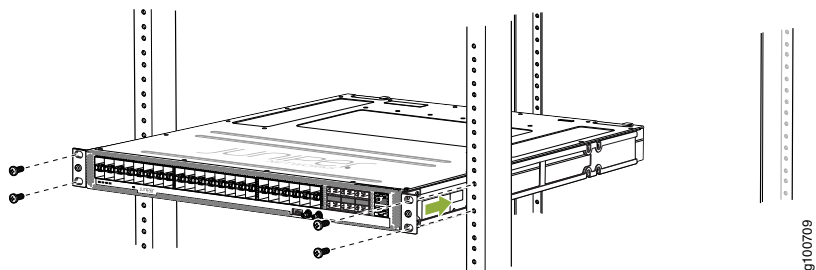

Figure 21: Install the ACX5448-M Router in a Four-Post Rack



7. Install mounting screws into each of the open front-mounting bracket holes aligned with the rack, starting from the bottom, and secure them tightly. [Figure 22](#), [Figure 23](#), and [Figure 24](#) show the router fully secured to the front rails of the four-post rack.

Figure 22: ACX5448 Router Secured by Front-Mounting Brackets

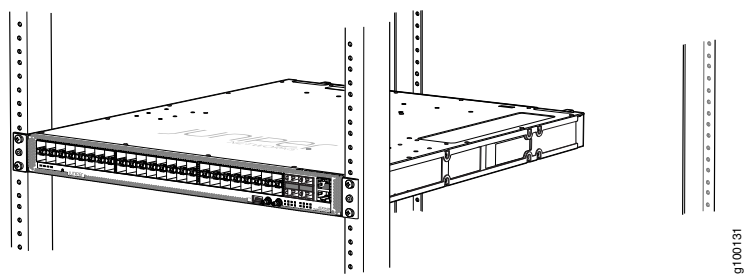

Figure 23: ACX5448-D Router Secured by Front-Mounting Brackets

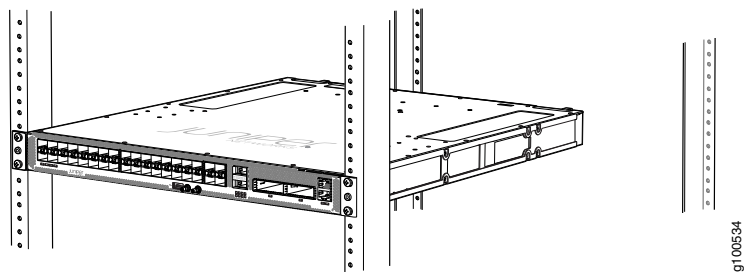
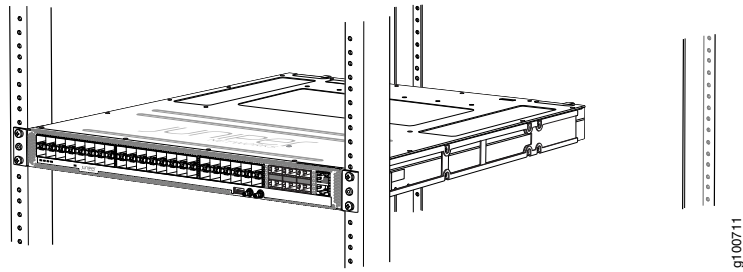

Figure 24: ACX5448-M Router Secured by Front-Mounting Brackets



8. On the rear of the chassis, slide the rear-mounting blades on either side of the chassis until the rear-mounting brackets at the end of the blades contact the rack rails (see [Figure 25](#) for the ACX5448 router, [Figure 26](#) for the ACX5448-D router, and [Figure 27](#) for the ACX5448-M router).

The mounting blades are movable. You can adjust the length of the blades according to the depth of the rack.

Figure 25: Install Mounting Blades on an ACX5448 Router

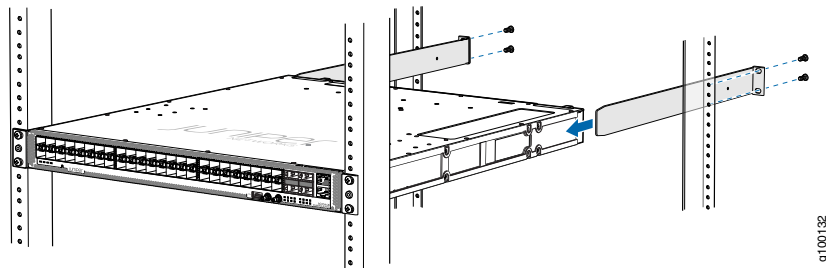

Figure 26: Install Mounting Blades on an ACX5448-D Router

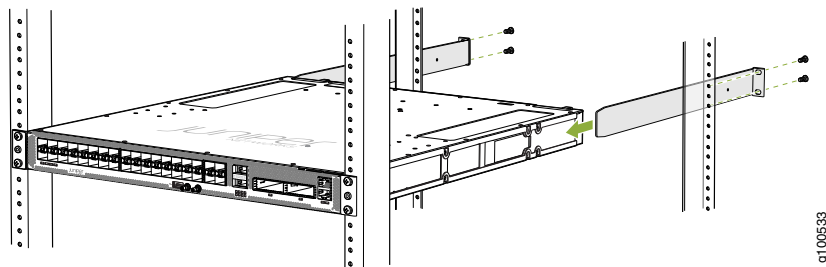
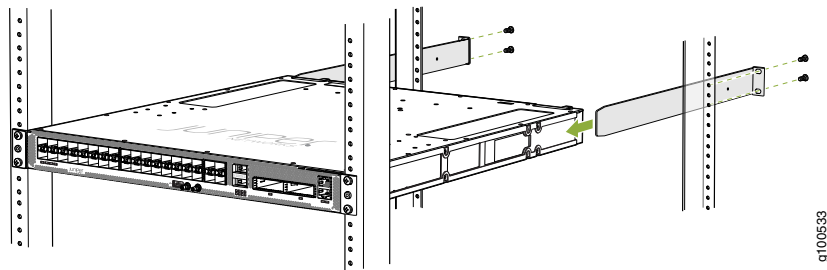

Figure 27: Install Mounting Blades on an ACX5448-M Router



9. Install mounting screws into each of the rear-mounting bracket holes aligned with the rack, starting from the bottom, and secure them tightly.
10. Visually inspect the alignment of the chassis. If you've installed the chassis properly in the rack, all the mounting screws on one side of the rack are aligned with the mounting screws on the opposite side, and the router is level. [Figure 28](#), [Figure 29](#), and [Figure 30](#) show the router fully secured and installed in a four-post rack.

Figure 28: ACX5448 Router Installed in the Rack

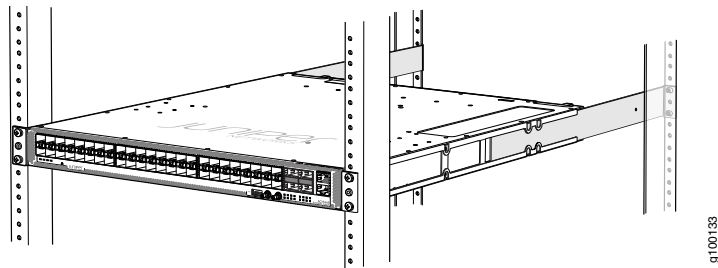

Figure 29: ACX5448-D Router Installed in the Rack

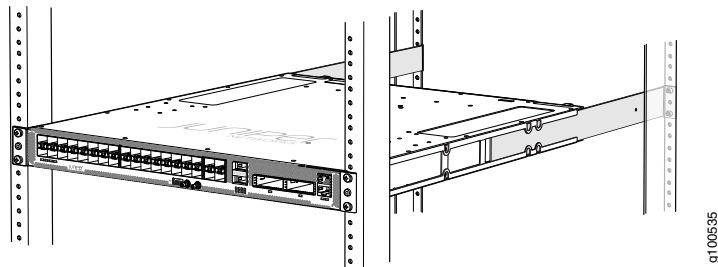
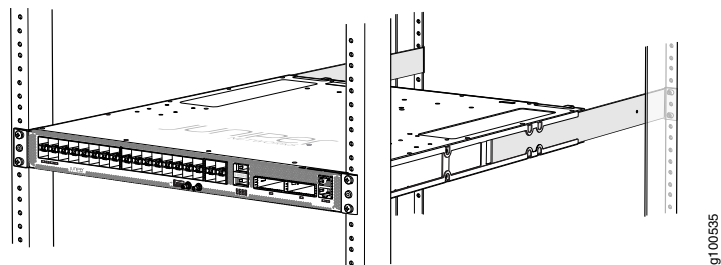

Figure 30: ACX5448-M Router Installed in the Rack



Step 3: Connect the Grounding Cable

To meet safety and electromagnetic interference (EMI) requirements and to ensure proper operation, you must ground the router properly before connecting power.

Figure 31, Figure 32, and Figure 33 show the grounding points on ACX5400 routers.

Figure 31: Grounding Points on the ACX5448 Router

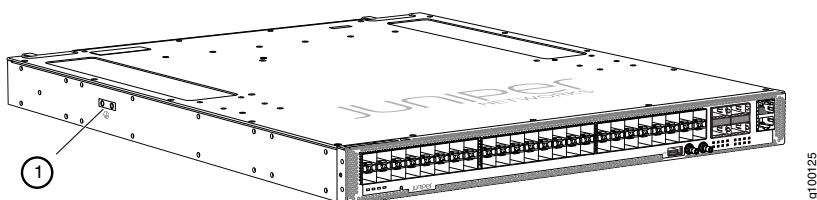

Figure 32: Grounding Points on the ACX5448-D Router

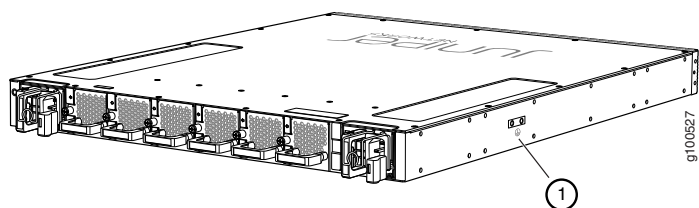
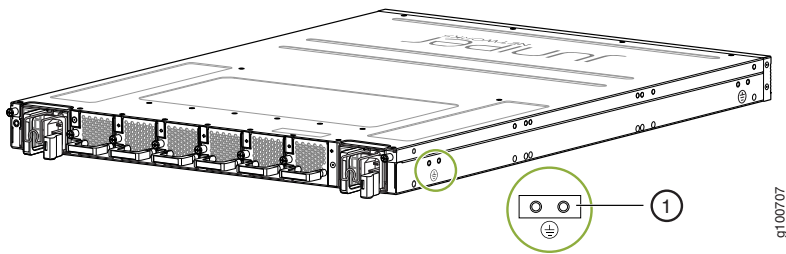

Figure 33: Grounding Points on the ACX5448-M Router



1–Grounding points

You need a protective earthing terminal bracket for connecting the chassis to earth ground. This two-holed bracket attaches on the side of the chassis through the mounting rail and provides a protective earthing terminal for the router. The grounding points are in the form of studs sized for #10–32 pan head screws. (You need to provide these screws with integrated washers as we do not ship them in the accessory kit). The grounding points are spaced at 0.63-in. (16-mm) centers.

You ground the router by connecting a grounding cable to earth ground and then attaching it to the chassis grounding points by using two #10–32 pan head screws. You must provide the grounding cables.

NOTE: The grounding lug required is a Panduit LCD10-10A-L or equivalent (not provided). The grounding lug accommodates 12 AWG (2.5 mm²) stranded wire. The grounding cable that you provide for the chassis must be the same size or heavier than the input wire of each PSM. We recommend the following minimum standards:

- 12 AWG (2.5 mm²), 60° C temperature-rated stranded wire for the ACX5448 router.
- 12 AWG (2.5 mm²), 90° C temperature-rated stranded wire for the ACX5448-D and ACX5448-M routers

To ground the ACX5400 router:

1. Verify that a licensed electrician has attached the cable lug provided with the router to the grounding cable.
2. Ensure that all grounding surfaces are clean and brought to a bright finish before grounding connections are made.
3. Connect the grounding cable to a proper earth ground.
4. For ACX5448-M routers, remove the dummy screws from the grounding point (see [Figure 35](#)).
5. Place the grounding cable lug over the grounding points on the side of the chassis (see [Figure 34](#) for ACX5448 and ACX5448-D routers and [Figure 35](#) for the ACX5448-M router).

Figure 34: Connect the Grounding Cable to the ACX5448 or ACX5548-D Router

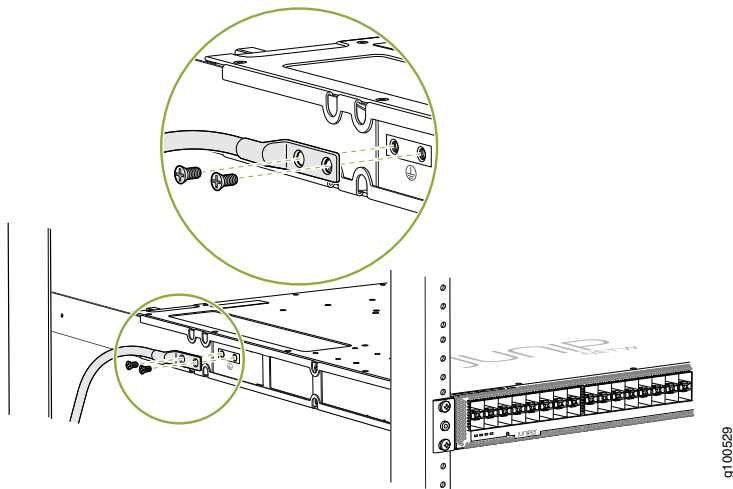
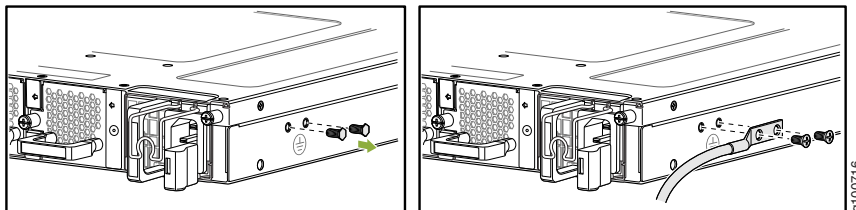

Figure 35: Connect the Grounding Cable to the ACX5448-M Router



6. Secure the grounding cable lug with the screws. The holes are sized to accommodate #10–32 pan head screws.
7. Dress the grounding cable and verify that it does not touch or block access to router components, and that it does not drape where people could trip over it.

Step 4: Connect Power Cables

IN THIS SECTION

- [Connect Power to an AC Router | 19](#)
- [Connect Power to a DC Router | 22](#)

Depending on the configuration, your router uses either AC or DC power supply modules (PSMs). Perform the appropriate procedures for each PSM in your router. The PSMs are hot-insertable and are field-replaceable units (FRUs). The ACX5400 routers use two PSMs, which install in the rear of the chassis in the slots provided.



WARNING: You must ground the router before connecting either the AC power cord or the DC power cable.



CAUTION: Do not mix AC and DC PSMs in the same chassis. Similarly, do not mix components with different airflow (AFO and AFI) in the same chassis.

Connect Power to an AC Router

Table 2 provides the AC power system input voltage for the ACX5400 routers.

Table 2: ACX5400 AC Power System Input Voltage

Item	Specification
AC input voltage	Operating range: 100–240 VAC

To connect AC power to an ACX5448 router:

1. Wrap and fasten one end of the ESD grounding strap around your bare wrist, and connect the other end of the strap to the ESD point on the chassis.
2. Power off the AC input appliance inlet on the source power supply.
3. Connect the power cord to the power source outlet.

NOTE: Each PSM must be connected to a dedicated AC power feed and a dedicated customer-site 2-pole circuit breaker. We recommend that you use a dedicated customer-site circuit breaker rated for 20 A (110 VAC) or 16 A (220 VAC) minimum, or as required by local code.

4. Push the end of the AC power cord retainer strip into the hole next to the inlet on the PSM faceplate on the router until it snaps into place. Ensure that the loop in the retainer strip faces toward the power cord.

Figure 36 shows the port on the AC PSM for an ACX5448 router where the power cord retainer is installed.

Figure 36: Power Cord Retainer Port on the AC PSM for ACX5448

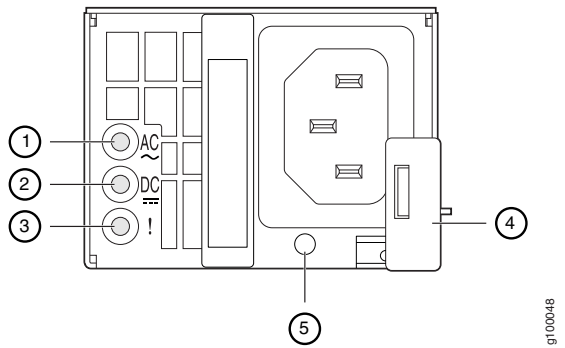

1–Input status LED	4–Ejector lever
2–Output status LED	5–AC power cord retainer port
3–Fault LED	

Figure 37 shows the power cord retainer installed on the AC PSM for ACX5448 router.

Figure 37: Power Cord Retainer Installed on the AC PSM for ACX5448

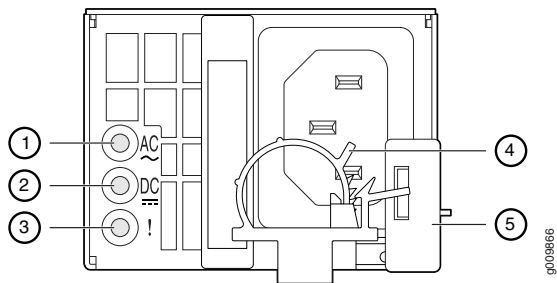

1–Input status LED	4–AC power cord retainer installed
2–Output status LED	5–Ejector lever
3–Fault LED	

5. Press the small tab on the retainer strip to loosen the loop. Slide the loop until you have enough space to insert the power cord coupler into the inlet.
6. Insert the power cord coupler firmly into the inlet.
7. Slide the loop toward the PSM until the loop is snug against the base of the coupler.
8. Press the tab on the loop and draw out the loop into a tight circle (see [Figure 38](#)).
9. Route the power cord appropriately. Verify that the power cord does not block the air exhaust and access to router components, or drape where people could trip over it.

10. Power on the source power supply.
11. Repeat Step 3 through Step 9 for the installing the remaining PSM.

Figure 38: Connect an AC Power Cord to the ACX5448 Router

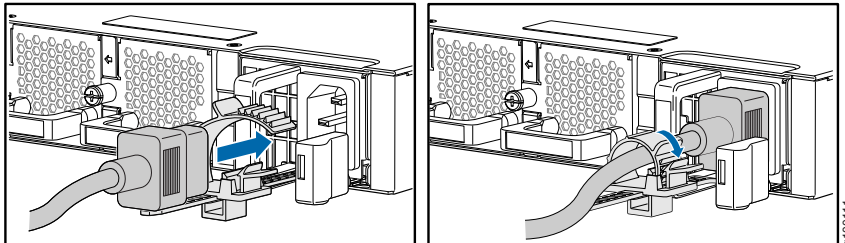

To connect AC power to an ACX5448-D or ACX5448-M router:

1. Wrap and fasten one end of the ESD grounding strap around your bare wrist, and connect the other end of the strap to the ESD point on the chassis.
2. Power off the AC input appliance inlet on the source power supply.
3. Connect the power cord to the source power supply. Insert the coupler end of the power cord into the AC power cord inlet on the AC power supply faceplate.

NOTE: Each PSM must be connected to a dedicated AC power feed and a dedicated customer-site 2-pole circuit breaker. We recommend that you use a dedicated customer-site circuit breaker rated for 20 A (110 VAC) or 16 A (220 VAC) minimum, or as required by local code.

4. Push the power cord retainer onto the power cord.

[Figure 39](#) shows the power cord retainer installed on the AC PSM for the ACX5448-D router and [Figure 40](#) shows how to connect an AC power cord to an ACX5448-D router.

Figure 39: Power Cord Retainer Installed on the AC PSM for ACX5448-D or ACX5448-M

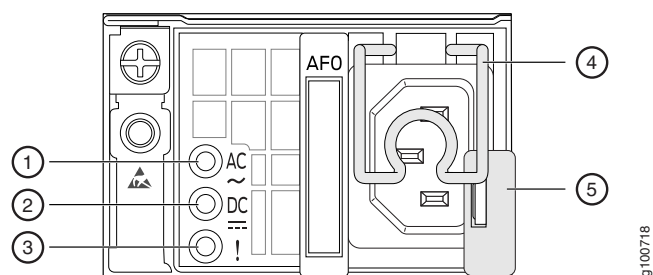

1–Input status LED	4–AC power cord retainer installed
2–Output status LED	5–Ejector lever
3–Fault LED	

Figure 40: Connect an AC Power Cord to the ACX5448-D or ACX5448-M Router

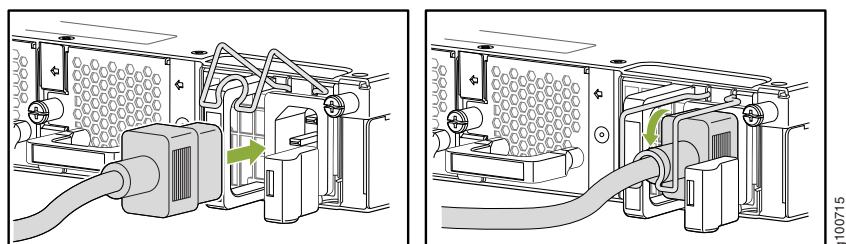

5. Power on the power supply at source.

Connect Power to a DC Router

Table 3 gives the DC power system input voltage for ACX5400 routers.

Table 3: ACX5448, ACX5448-D, and ACX5448-M DC Power System Input Voltage

Item	Specification
DC input voltage (ACX5448)	Rated operating voltage: -48 VDC to -60 VDC Operating voltage range: -40.8 VDC through -72 VDC
DC input voltage (ACX5448-D)	Rated operating voltage: -48 VDC to -60 VDC Operating voltage range: -43.2 VDC through -72 VDC
DC input voltage (ACX5448-M)	Rated operating voltage: -48 VDC to -60 VDC Operating voltage range: -43.2 VDC through -72 VDC

To connect DC power to an ACX5400 router:

1. Wrap and fasten one end of the ESD grounding strap around your bare wrist, and connect the other end of the strap to the ESD point on the chassis.
2. Verify that the DC power cables are correctly labeled before making connections to the power supply. In a typical power distribution scheme where the return is connected to chassis ground at the battery plant, you can use a multimeter to verify the resistance of the -48V and RTN DC cables to chassis ground:
 - The cable with very low resistance (indicating a closed circuit) to chassis ground is positive (+). You install this cable on the V+ (return) DC power input terminal.
 - The cable with very high resistance (indicating an open circuit) to chassis ground is negative (-). You install this cable on the V- (input) DC power input terminal.



CAUTION: You must ensure that power connections maintain the proper polarity. The power source cables might be labeled (+) and (-) to indicate their polarity. There is no standard color coding for DC power cables. The color coding used by the external DC power source at your site determines the color coding for the leads on the power cables that attach to the DC power input terminals on each PSM.

3. Ensure that the input 2-pole circuit breaker is open so that the voltage across the DC power source cable leads is 0 V and that the cable leads do not become active while you are connecting DC power.

NOTE: The V+ terminals are referred to as +RTN, and V- terminals are referred to as -48 V in *DC Power Wiring Sequence Warning*.

4. Ensure that the DC PSMs are fully inserted in the chassis.
5. Remove the terminal block cover. The terminal block cover is a piece of clear plastic that snaps into place over the terminal block (see [Figure 41](#)).
6. Remove the screws on the terminals by using the screwdriver. Save the screws.



WARNING: Ensure that the power cables do not block access to device components or drape where people can trip over them.

7. Connect each PSM to the power sources. Secure power source cables to the PSMs by screwing the ring lugs attached to the cables to the appropriate terminals by using the screw from the terminals (see [Figure 41](#)).

The ACX5400 router is designed to operate with a DC power supply that has a single, non-redundant, feed input. For source redundancy, you must install two DC PSMs in the ACX5400; connect source (A) to one PSM and connect source (B) to the second PSM. This configuration provides the commonly deployed A/B feed redundancy for the system.

The terminal block of the PSM has four terminals labeled V+, V+, V-, and V- for connecting DC power source cables labeled positive (+) and negative (-). The V+ terminals are shunted internally, as are the V- terminals.



CAUTION: The connection between each power source and PSM must include a 2-pole circuit breaker.

Do not connect two sources to a single PSM because doing so can potentially cause circulating current in feed wires whenever there is any difference in the voltage of the two sources.

- a. Secure the ring lug of the positive (+) DC power source cable to the V+ terminal on the DC PSM.
- b. Secure the ring lug of the negative (-) DC power source cable to the V- terminal on the DC PSM.
- c. Tighten the screws on the PSM terminals until snug using the screwdriver. Do not overtighten—apply between 5 in-lb (0.56 Nm) and 6 in-lb (0.68 Nm) of torque to the screws.



CAUTION: The V+ terminals are shunted internally, as are the V- terminals. The same polarity terminal can be wired together from the same source to provide an additional current path in a higher power chassis. Do not connect the terminals to different sources.

Figure 41: Connect a DC Power Cable to an ACX5400 Router

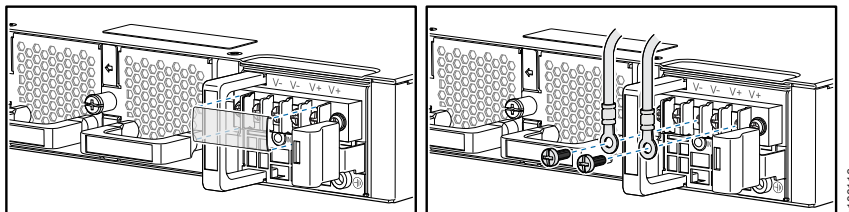

8. Replace the terminal block cover.
9. Close the input 2-pole circuit breaker.

NOTE: The switch powers on as soon as power is provided to the power supply. There is no power switch on the device.

10. Verify that the **IN** and **OUT** LEDs on the power supply are lit green and are on steadily.



CAUTION: A system reboot with Routing Engine FPGA version 7.1 might not successfully boot the Junos OS software. In case of a system reboot failure, you need to power cycle the switch. To check the current FPGA version, issue the **show chassis firmware** command.

Step 5: Connect External Devices and Cables

IN THIS SECTION

- [Connect the Router to a Network for Out-of-Band Management | 25](#)
- [Connect the Router to a Console Device | 26](#)
- [Connect the Router to External Clocking and Timing Devices | 27](#)

All the connections to the router are made through the front panel.

Connect the Router to a Network for Out-of-Band Management

To connect the router to a network for out-of-band management, connect an Ethernet cable with RJ-45 connectors to the **MGMT** port on the router. We provide one Ethernet cable with the router.

NOTE: Use shielded CAT5e cable for the **CON** and **MGMT** ports on the router.

To connect to the **MGMT** port on the front panel of the router:

1. Turn off power to the management device.
2. Plug one end of the Ethernet cable ([Figure 42](#) shows the connector) into the **MGMT** port on the router.

3. Plug the other end of the cable into the network device.

Figure 42: Ethernet Cable Connector

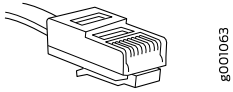

Table 4 describes the out-of-band management port for the ACX5400 router.

Table 4: Out-of-Band Management Port on the ACX5400 Router

Label	Callout	Description
MGMT	3 (See Figure 1.)	Dedicated management channel for device maintenance. It is also used by system administrators to monitor and manage the router remotely.

Connect the Router to a Console Device

To use a system console to configure and manage the router, connect it to the appropriate **CON** port on the router. The console port is used to connect a laptop or console terminal to configure the router (see [Figure 43](#) and [Figure 44](#)). The console port accepts a cable with an RJ-45 connector. We provide one serial cable with an RJ-45 connector and a DB-9 connector with the router.

NOTE: Use shielded CAT5e cable for connecting the **CON** and **MGMT** ports on the router.

To connect a management console:

1. Turn off power to the console device.
2. Plug the RJ-45 end of the serial cable (see [Figure 42](#)) into the **CON** port on the router.
3. Plug the female DB-9 end into the device's serial port.

NOTE:

For console devices, configure the serial port as follows:

- Baud rate—9600
- Parity—N
- Data bits—8
- Stop bits—1
- Flow control—none

Figure 43: Connecting the Router to a Management Console Through a Console Server

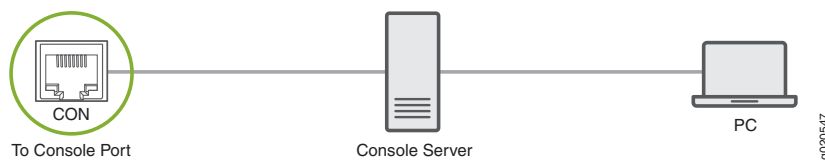

Figure 44: Connecting the Router Directly to a Management Console



Table 5 describes the console port for the ACX5400 router.

Table 5: Console Port on the ACX5400 Router

Label	Callout	Description
CON	4 (See Figure 1.)	Connect a laptop or console terminal to configure the router.

Connect the Router to External Clocking and Timing Devices

The router has two SMB connector ports that support 1-PPS and 10-MHz timing devices.

NOTE: Ensure that you use a cable of 3 m or less in length for the 10-MHz and 1-PPS connectors.

To connect the SMB to BNC coaxial cable to the external clocking input port:

1. Connect one end of the SMB to BNC coaxial cable to either the 1-PPS connector or the 10-MHz connector on the router.
2. Connect the other end of the SMB to BNC coaxial cable to the 1-PPS or 10-MHz measurement equipment.

NOTE: Ensure that the 10-MHz or 1-PPS source network equipment contains low-voltage complementary metal oxide semiconductor (CMOS) or is compatible with low-voltage (3.3 V) transistor-transistor logic (TTL).

Table 6 describes the clocking ports on the ACX5400 router.

Table 6: Clocking Port on the ACX5400 Router

Label	Callout	Description
10M	5	GPS ports.
PPS	(See Figure 1.)	

Step 6: Perform Initial Software Configuration

IN THIS SECTION

- [Enter Configuration Mode | 29](#)
- [Configure User Accounts and Passwords | 29](#)
- [Configure System Attributes | 30](#)
- [Commit the Configuration | 31](#)

This procedure connects the router to the network but does not enable it to forward traffic. For complete information about configuring the router to forward traffic, including examples, see the Junos OS configuration guides.

To configure the software:

Enter Configuration Mode

1. Verify that the router is powered on.
2. Log in as the root user. As the root user, you don't need to enter a password.
3. Start the CLI.

```
root# cli
root@host>
```

4. Enter configuration mode.

```
root@host> configure
[edit]
root@host#
```

Configure User Accounts and Passwords

For information about using an encrypted password or an SSH public key string (DSA or RSA), see *Configuring the Root Password and user*.

1. Add a password to the root administration user account. Enter a cleartext password.

```
[edit]
root@host# set system root-authentication plain-text-password
New password: password
Retype new password: password
```

2. Create a management console user account.

```
[edit]
root@host# set system login user user-name authentication plain-text-password
New Password: password
Retype new password: password
```

3. Set the user account class to **super-user**.

```
[edit]
root@host# set system login user user-name class super-user
```

Configure System Attributes

1. Configure the name of the router. If the name includes spaces, enclose the name in quotation marks (" ").

```
[edit]
root@host# set system host-name host-name
```

2. Configure the router's domain name.

```
[edit]
root@host# set system domain-name domain-name
```

3. Configure the IP address and prefix length for the router's Ethernet interface.

```
[edit]
root@host# set interfaces fxp0 unit 0 family inet address address/prefix-length
```

4. Configure the IP address of a backup router, which is used only while the routing protocol is not running.

```
[edit]
root@host# set system backup-router address
```

5. Configure the IP address of a DNS server.

```
[edit]
root@host# set system name-server address
```

6. (Optional) Configure the static routes to remote subnets with access to the management port. Access to the management port is limited to the local subnet. To access the management port from a remote subnet, you must add a static route to that subnet within the routing table. For more information about static routes, see the *Junos OS Administration Library*.

```
[edit]
root@host# set routing-options static route remote-subnet next-hop destination-IP retain no-readvertise
```

7. Configure the Telnet service at the [edit system services] hierarchy level.

```
[edit]
root@host# set system services telnet
```

Commit the Configuration

1. (Optional) Display the configuration to verify that it is correct.

```
[edit]
root@host# show
system {
  host-name host-name;
  domain-name domain-name;
  backup-router address;
  root-authentication {
    authentication-method (password | public-key);
  }
  name-server {
    address;
  }
}
interfaces {
  fxp0 {
    unit 0 {
      family inet {
        address address/prefix-length;
      }
    }
  }
}
}
```

2. Commit the configuration to activate it on the router.

```
[edit]
root@host# commit
```

3. (Optional) Configure additional properties by adding the necessary configuration statements. Then commit the changes to activate them on the router.

```
[edit]
root@host# commit
```

4. When you have finished configuring the router, exit configuration mode.

```
[edit]
root@host# exit
root@host>
```

Safety Warnings



WARNING: See installation instructions before connecting the router. This is a summary of safety warnings. For a complete list of warnings for this router, including translations, see the ACX5448 *Universal Metro Router Hardware Guide* at <https://www.juniper.net/documentation/>.



WARNING: The intrabuilding port(s) of the router is suitable for connection to intrabuilding or unexposed wiring or cabling only. The intrabuilding port(s) of the router **MUST NOT** be metalically connected to interfaces that connect to the OSP or its wiring. These interfaces are designed for use as intrabuilding interfaces only (Type 2 or Type 4 ports as described in GR-1089-CORE, Issue 4) and require isolation from the exposed OSP cabling. The addition of primary protectors is not sufficient protection to connect these interfaces metalically to OSP wiring.



CAUTION: Before removing or installing components of a router, attach an ESD strap to an ESD point, and place the other end of the strap around your bare wrist. Failure to use an ESD strap could result in damage to the router.



CAUTION: Use an external surge protective device (SPD) at the AC input of the router.

- Only trained and qualified personnel must install or replace the router.
- Perform only the procedures described in this quick start or the ACX5448 *Universal Metro Router Hardware Guide* at <https://www.juniper.net/documentation/>. Other services should be performed by authorized service personnel only.
- Read the installation instructions before you connect the router to a power source.
- Before installing the router, read the guidelines for site preparation in the ACX5448 *Universal Metro Router Hardware Guide* at <https://www.juniper.net/documentation/> to make sure that the site meets power, environmental, and clearance requirements for the router.
- For the cooling system to function properly, the airflow around the chassis must be unrestricted. Allow at least 6 in. (15.2 cm) of clearance between side-cooled routers. Allow 2.8 in. (7 cm) between the side of the chassis and any non-heat-producing surface such as a wall.
- When installing the router, do not use a ramp inclined more than 10 degrees.
- Manually installing the router requires two people for an empty chassis and three people for a fully configured router to lift the chassis. Before lifting the chassis with only two people, remove the components as described in the ACX5448 *Universal Metro Router Hardware Guide* at <https://www.juniper.net/documentation/>. To prevent injury, keep your back straight and lift with your legs, not your back. Do not attempt to lift the chassis by the power supply handles.

- Mount the router at the bottom of the rack if it is the only unit in the rack.
- When mounting the router in a partially filled rack, load the rack from the bottom to the top with the heaviest component at the bottom of the rack.
- If the rack is provided with stabilizing devices, install the stabilizers before mounting or servicing the router in the rack.
- When removing or installing an electrical component, always place it component-side up on a flat antistatic surface or in an electrostatic bag.
- When you install the router, always make the ground connection first and disconnect it last.
- Wire the DC power supply using the appropriate lugs. When connecting power, the proper wiring sequence is ground to ground, +RTN to +RTN, then -48 V to -48 V. When disconnecting power, the proper wiring sequence is -48 V to -48 V, +RTN to +RTN, then ground to ground. Always connect the ground wire first and disconnect it last.
- Do not work on the system or connect or disconnect cables during electrical storms.
- Before working on equipment that is connected to power lines, remove jewelry, including rings, necklaces, and watches. Metal objects heat up when connected to power and ground and can cause serious burns or become welded to the terminals.
- Failure to observe these safety warnings can result in serious physical injury.
- AC power cable warning (Japan):



WARNING: The attached power cable is only for this product. Do not use the cable for another product.

注意

附属の電源コードセットはこの製品専用です。
他の電気機器には使用しないでください。

9017253

Compliance Statements for NEBS

- The equipment is suitable for installation as part of the Common Bonding Network (CBN).
- The equipment is suitable for installation in locations where the National Electrical Code (NEC) applies.
- The battery return connection is to be treated as an isolated DC return (that is, DC-I), as defined in GR-1089-CORE.
- You must provision a readily accessible device outside of the equipment to disconnect power. The device must also be rated based on local electrical code practice.

Compliance Statements for EMC Requirements

IN THIS SECTION

- Canada | 34
- European Community | 34
- Israel | 34
- Japan | 35
- United States | 35

Canada

CAN ICES-3 (A)/NMB-3(A)

European Community

This is a Class A product. In a domestic environment, this product might cause radio interference in which case the user might be required to take adequate measures.

Israel

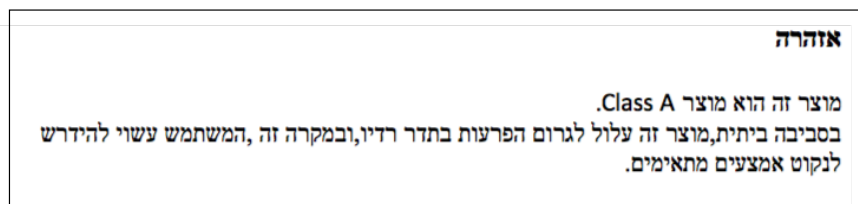

Translation from Hebrew—Warning: This product is Class A. In residential environments, the product might cause radio interference, and in such a situation, the user might be required to take adequate measures.

Japan

この装置は、クラス A 情報技術装置です。この装置を家庭環境で使用すると電波妨害を引き起こすことがあります。この場合には使用者が適切な対策を講ずるよう要求されることがあります。 VCCI-A

The preceding translates as follows:

This is a Class A product based on the standard of the Voluntary Control Council for Interference by Information Technology Equipment (VCCI). If this product is used near a radio or television receiver in a domestic environment, it might cause radio interference. Install and use the equipment according to the instruction manual. VCCI-A.

United States

The hardware equipment has been tested and found to comply with the limits for a Class A digital device, pursuant to Part 15 of the FCC Rules. These limits are designed to provide reasonable protection against harmful interference when the equipment is operated in a commercial environment. This equipment generates, uses, and can radiate radio frequency energy and, if not installed and used in accordance with the instruction manual, might cause harmful interference to radio communications. Operation of this equipment in a residential area is likely to cause harmful interference in which case the user will be required to correct the interference at his own expense.

Contacting Customer Support

You can contact Juniper Networks Technical Assistance Center (JTAC) 24 hours a day, 7 days a week in one of the following ways:

- On the Web, using the Service Request Manager link at:
<https://support.juniper.net/support/>
- By telephone:
 - From the US and Canada: 1-888-314-JTAC
 - From all other locations: 1-408-745-9500

NOTE: If contacting JTAC by telephone, enter your 12-digit service request number followed by the pound (#) key if this is an existing case, or press the star (*) key to be routed to the next available support engineer.

When requesting support from JTAC by telephone, be prepared to provide the following information:

- Your existing service request number, if you have one
- Details of the failure or problem
- Type of activity being performed on the device when the problem occurred
- Configuration data displayed by one or more **show** commands
- Your name, organization name, telephone number, fax number, and shipping address

The support representative validates your request and issues an RMA number for return of the component.